

# Party City Holdings Inc (PCHI)

## Vendor Standards Manual (VSM)



Revised January 2022



## Table of Contents

<b><u>Section</u></b>	<b><u>Title</u></b>	<b><u>Page #</u></b>
	Introduction	4
	2022 Vendor Standards Manual (VSM) Acknowledgement	6
1	Supplier Code of Conduct	7
	Code of Business Practices	10
2	Terms and Conditions	21
3ac	Merchandise Information – Retail: Party City, Party America, Halloween City	31
3b	Merchandise Information – Wholesale: Amscan, Anagram International	37
4ac	Electronic Data Interchange (EDI) – Retail: Party City, Party America, Halloween City	50
5ac	Packaging and Packing Instructions – Retail: Party City, Party America, Halloween City	61
5b	Packaging and Packing Instructions – Wholesale: Amscan, Anagram International	70
6ac	Product Safety Quality Assurance – Retail: Party City, Party America, Halloween City	89
6b	Product Safety Quality Assurance – Wholesale: Amscan, Anagram International	95
7b	Imports - Wholesale: Amscan, Anagram International	121
	Exports – Wholesale: Amscan, Anagram International	140
8abc	Transportation Routing Guide	145



**HALLOWEEN CITY**



9ac	Accounts Payable – Retail: Party City, Party America, Halloween City	149
9b	Accounts Payable – Wholesale: Amscan, Anagram International	155
10	Reimbursement and Waiver Policy	161
11	Contact Information	170
12	Partycity.com Web Fulfillment – Retail: Party City	175
	Appendix	178



**HALLOWEEN CITY**



## Introduction

Within this Vendor Standards Manual (VSM) you will find a set of performance expectations. Rather than being all-inclusive, our expectations are intended to better define elements of your role in servicing our organization. They do not replace good business practices, legal requirements or the need to use common sense when managing our business. The Vendor Standards Manual covers vendor requirements for Party City Holdings, Inc. (PCHI) and its subsidiaries which include both corporate and franchise retail locations. These standards will be supplemented from time to time with changes emailed to the vendor contact on record.

## Vendor Participation Agreement (VPA)

PCHI maintains a vendor database containing payment terms and contact information. Contact information includes a primary contact person as well as contacts in sales, accounts receivable, marketing, **product development**, logistics, quality control, **purchase order receipt, compliance, portal contact, company officer(s)** and electronic data interchange (EDI). Each contact must include first and last name, address, phone, fax, and email address. It is the responsibility of each vendor to ensure all information contained in this database is accurate by completing a Vendor Participation Agreement.

**An annual updated signed VPA form will be required. If no changes are required, a signed and dated VPA will still be necessary. Vendor will have 15 business days to return all documentation once published to them.**

## Changes to Vendor Information

Documentation must be on company letterhead and signed by a senior officer of your company. All changes must be received 14 days prior to their effective date.

Changes would include, but are not limited to:

- Change in Company Name or address (Remittance, shipping, or Return to Vendor addresses)
- Start, change or termination of a factoring relationship
- Change in company ownership: If a change in ownership occurs and the new owner is not currently in our vendor file as an authorized vendor, the company will be considered a new vendor and may be required to complete a *New Vendor Package (NVP)*.
- Change in legal structure
- Bankruptcy Filings

The letter communicating changes must contain the following information:

- Your company name and PCHI vendor number
- Statement of the change being communicated
- Signature of a senior officer or agent

**Do not send any vendor updates or changes to store locations.** Store personnel cannot approve or process any vendor changes.

Changes related to factoring relationships must include:

- Written or emailed confirmation from the factor terminating the relationship
- Written or emailed confirmation from the new factor (if applicable)
- Effective date and authorization to release payment to the new factor



**HALLOWEEN CITY**



For Party City (retail), changes should be emailed to [vendorrelations@partycity.com](mailto:vendorrelations@partycity.com) or faxed to 973-983-4915 with a follow-up email to the lead Merchant.

For Amscan (wholesale), changes should be emailed to [vendorrelations@amscan.com](mailto:vendorrelations@amscan.com) or faxed to 914-784-4302

For Anagram International, changes should be emailed to [vendorrelations@anagramintl.com](mailto:vendorrelations@anagramintl.com) or faxed to 952-949-6491

**PCHI reserves the right to hold payments pending receipt of this documentation.**

## **Non-Merchandise**

For all Non-Merchandise related issues, standards and guidelines can be found in a separate manual distributed by the Construction/Facilities team. Freight collect vendors must still adhere to guidelines set in the Transportation Routing Guide, Section 8 of this manual.

### **Please Note:**

**PCHI is both a wholesale and retail organization. For your convenience, the sections are divided in the following manner:**

- Section A (RETAIL) - is for vendors that ship directly to our US retail locations**
- Section B (WHOLESALE) - is for vendors shipping to our wholesale locations**
- Section C (HALLOWEEN CITY) - is for our vendors shipping to Halloween City (HC)**



**PCHI Notification and Acknowledgement of  
2022 Vendor Standards Manual (VSM)**

**Name of Parent Company:** \_\_\_\_\_

**Name of all Subsidiaries:** \_\_\_\_\_

Some aspects of the VSM do not pertain to Sub-Vendors, many aspects do. Sub-Vendors should read the Vendor Standards Manual. The VSM applies to all vendor/sub-vendors shipping to all Party City Holdings Inc (PCHI) including its subsidiaries and affiliates which consist of, among others, entities doing business under Party City, Party America, Halloween City, Anagram International, and Amscan tradenames.

\_\_\_\_\_ (Company Name) understands it is our responsibility to complete a Vendor Participation Agreement (VPA) and return to Party City or Amscan in a timely fashion. Vendor is to furnish PCHI with up to date information. Vendor should submit all changes to vendor information on company letterhead signed by an executive. For Party City, changes should be emailed to [vendorrelations@partycity.com](mailto:vendorrelations@partycity.com) or faxed to 973-983-4915. For Amscan, changes should be emailed to [vendorrelations@amscan.com](mailto:vendorrelations@amscan.com) or faxed to 914-784-4302. For Anagram International, changes should be emailed to [vendorrelations@anagramintl.com](mailto:vendorrelations@anagramintl.com) or faxed to 952-949-6491.

\_\_\_\_\_ (Company Name) understands it is our responsibility to provide PCHI with a *Certificate of Insurance* and furnish PCHI with the latest certificate, records, and all applicable documentation. We will replace the Certificate of Insurance if changes or expiration occur. Please refer to the Terms and Conditions, Section 2.

\_\_\_\_\_ (Company Representative) warrants that he/she is authorized to bind \_\_\_\_\_ (Company Name) to the representations contained herein and acknowledges that PCHI is relying on this representation to move forward.

\_\_\_\_\_ (Company Name) has read, understands, and agrees to the Terms and Conditions, Section 2 and all other applicable sections of the VSM.

**Authorized Company Representative (Print Name):** \_\_\_\_\_

**Title:** \_\_\_\_\_

**Signature:** \_\_\_\_\_

**Date:** \_\_\_\_\_

**Contact Information:** \_\_\_\_\_

All vendors that ship direct to Party City retail locations must fax or email this acknowledgement form to 973.983.4915 or [vendorrelations@partycity.com](mailto:vendorrelations@partycity.com).

All vendors that ship to Amscan must fax or email this acknowledgment form to 914.784.4302 or [vendorrelations@amscan.com](mailto:vendorrelations@amscan.com).

All vendors that ship to Anagram International must fax or email this acknowledgement form to 952.949.6491 or [vendorrelations@anagramintl.com](mailto:vendorrelations@anagramintl.com).



**HALLOWEEN CITY**



**Section - 1**

**Supplier Code of Conduct**

Our Supplier Code of Conduct sets forth requirements for suppliers of our products with respect to labor standards and working conditions. The principles embodied in our Code are designed to be consistent with core conventions of the International Labor Organization (ILO), the specialized agency of the United Nations focused on global labor standards, codes set forth by key labor standards organizations, as well as codes required by brands, retailers and licensors who are customers of PCHI.

At PCHI, we are committed to:

- Integrity and excellence in every aspect of our business
- Ethical conduct in all of our operations;
- Respect for the rights of all individuals; and
- Protection and care for the environment.

We expect these same commitments to be shared by all suppliers of PCHI merchandise. At a minimum, we require that all suppliers of PCHI merchandise meet the following standards:

**Child Labor**

Suppliers shall not use child labor  
 The term "child" refers to a person younger than 15 (or 14 where local law allows) or, if higher, the local legal minimum age for employment or the age for the completing compulsory education.

Suppliers employing young persons who do not fall within the definition of "children" will also comply with any laws and regulations applicable to such persons.

**Involuntary Labor**

Suppliers shall not use any forced or involuntary labor, whether, prison, bonded, indentured or otherwise.

**Coercion and Harassment**

Suppliers shall treat each employee with dignity and respect, and shall not use corporal punishment, threats of violence or other forms of physical, sexual, psychological or verbal harassment or abuse.

**Nondiscrimination**

Suppliers shall not discriminate in hiring and employment practices, including salary, benefits, advancement, discipline, termination or retirement, on the basis of race, religion, age, nationality, social or ethnic origin, sexual orientation, gender, political opinion or disability.

**Association**

Suppliers shall respect the rights of employees to associate, organize and bargain collectively in a lawful and peaceful manner, without penalty or interference.



**HALLOWEEN CITY**



**Section - 1**

**Health and Safety**

Suppliers shall provide employees with a safe and healthy workplace in compliance with all applicable laws and regulations, ensuring at a minimum reasonable access to potable water and sanitary facilities, fire safety, and adequate lighting and ventilation. Suppliers will also ensure that the same standards of health and safety are applied in any housing that they provide for an employee and their immediate family.

**Compensation and Benefits**

We expect suppliers to recognize that wages are essential to meeting employees' basic needs. Suppliers shall, at a minimum, comply with all applicable wage and hour laws and regulations, including those relating to minimum wages, overtime, maximum hours, piece rates and other elements of compensation, and provide legally mandated benefits. Except in extraordinary business circumstances, suppliers shall not require employees to work more than the lesser of (a) 48 hours per week and 12 hours overtime or (b) the limits on regular and overtime hours allowed by local law or, where local law does not limit the hours of work, the regular work week plus 12 hours overtime. In addition, except in extraordinary business circumstances, employees shall be entitled to at least one day off in every seven-day period.

Suppliers shall compensate employees for overtime hours at such premium rate as is legally required or, if there is no legally prescribed premium rate, at a rate at least equal to the regular hourly compensation rate.

Where local industry standards are higher than applicable legal requirements, we expect suppliers to meet the higher standards.

---

**Protection of the Environment**

Suppliers shall comply with all applicable environmental laws and regulations, including but not limited to those laws related to waste disposal, air emissions, discharges, toxic substances and hazardous waste disposal.

---

**Other Laws**

Suppliers shall comply with all applicable laws and regulations, including those pertaining to Emergency Preparedness, the manufacturing and distribution of PCHI merchandise, Immigration, Customs, Homeland Security, and International Financial Reporting Standards (IFRS) or Generally Accepted Accounting Principles (GAAP). All references to "applicable laws and regulations" in this Code of Conduct include local and national codes, rules and regulations, for example the Foreign Corrupt Practices Act (FCPA) and UK Bribery Act, as well as





**HALLOWEEN CITY**



**Section - 1**

applicable treaties and voluntary industry standards in the markets where PCHI products are sold.

---

**Subcontracting**

Suppliers shall not use subcontractors for the manufacture of PCHI merchandise or components without written consent by PCHI, and only after the subcontractor has entered into a written commitment with PCHI to comply with this Code of Conduct.

---

**Management Systems**

Suppliers shall have management systems in place to ensure compliance with this Code of Conduct and maintain on site documentation that may be needed to demonstrate compliance with this Code of Conduct. Suppliers shall take appropriate measures to ensure that the provisions of this Code of Conduct are communicated to employees, including provision to an employee upon request and the prominent posting of a copy of this Code of Conduct in the local language and in a place readily accessible to all employees at all times.

PCHI reserves the right to take all appropriate measures, in accordance with applicable terms and conditions, against any vendor that fails to comply with this code.



**HALLOWEEN CITY**



## Section - 1

### Code of Business Practices

The Company is committed to human rights, ethical behavior, the environment, and compliance with anti-bribery and other applicable laws, and we expect our vendors to share our commitment. By agreeing to the terms and conditions of this VSM, you are also agreeing to the following (which is further summarized in the PCHI Supplier Code of Conduct enclosed in [Section 1a](#) of this VSM):

#### Labor Practices

- Working hours per week, wages, and overtime practices comply with the standards set by law. In the absence of applicable law, suppliers must provide humane working conditions that allow for reasonable working hours and rest, and suppliers must not improperly withhold wages, delay wage payments, or pay wages irregularly; and
- Vendors must comply with the C138 Minimum Age Convention (1973) and C182 Worst Form of Child Labour Convention (1999) of the International Labour Organization. Notwithstanding the requirements of these conventions, no individual may be employed who is under 15 years of age; and
- No forced or prison labor may be employed; workers are free to leave and guards are posted only for normal security reasons; and
- All workers are entitled to sick and maternity benefits as provided by law; and
- All workers are entitled to freely exercise their rights of employee representation, as provided by law.

#### The Workplace

- Factories provide a safe working environment for their employees and comply with or exceed all applicable local laws concerning sanitation, fire safety, structural safety, and risk protection; and
- Factories are properly lighted and ventilated, and that aisles and exits are accessible at all times; and
- There is adequate medical assistance available in emergencies, and that designated employees are trained in its use; and
- Appropriate protective equipment is used, and employees are trained in its use; and
- Safeguards on machinery meet or exceed local laws and employees are trained in the proper use of machinery; and
- There are adequate toilet facilities which meet local hygiene requirements, and they are properly maintained; and
- There are facilities or appropriate provisions for meals and other breaks; and

- If a factory provides housing for its employees, it will ensure that dormitory rooms and sanitary facilities meet basic needs, are adequately ventilated and meet fire safety and other local laws; and
- No mental or physical disciplinary practices are employed.

### **Documents Required**

1. Vendor Anti Corruption Certification to be completed by all third parties doing business with the Company outside of the US and Canada.
2. Due Diligence Questionnaire to be completed by all third parties doing business with the Company outside of the United States and Canada.
3. The latest version of our Anti-Corruption Policy Statement.

The above 3 required documents must be completed and sent back to [compliance@partycity.com](mailto:compliance@partycity.com) and c.c. to [vendorrelations@amscan.com](mailto:vendorrelations@amscan.com).

4. Conflict Minerals Letter with 17 CFR 240 and 240b Reply together with the Conflict Minerals Reporting Template (CRMT) - to be emailed to [sp.compliance@amscan.com](mailto:sp.compliance@amscan.com) and c.c. [compliance@amscan.com](mailto:compliance@amscan.com)

### **FCPA, UK Bribery Act and Anti-Corruption Policy**

#### **I. INTRODUCTION AND SCOPE**

Corruption violates the public's trust, threatens national and international economic and social development and substantially impedes fair trade. To combat corruption, most, if not all, of the countries in which Party City Holdings Inc. and its respective affiliates and subsidiaries (collectively, "Party City" or "the Company") conduct business have enacted anti-corruption/anti-bribery laws and regulations (hereinafter "Anti-Corruption Laws").

Party City believes in conducting business ethically, honestly and with integrity. It has been, and continues to be, the policy of the Company to comply with the United States Foreign Corrupt Practices Act (the "**FCPA**") and the UK Bribery Act 2010 (the "**UK Bribery Act**"), as well as all other applicable Anti-Corruption Laws wherever we operate. Accordingly, the Company has adopted this FCPA, UK Bribery Act and Anti-Corruption Policy (the "Policy") to set standards of conduct consistent with the FCPA, UK Bribery Act, and applicable Anti-Corruption Laws, and to establish processes for continued compliance.

This Policy applies to the Company's officers, directors, and employees. The Company also expects that its Business Partners adhere to the principles of the Policy and conduct their business with similar integrity. The term "Business Partner" is broadly interpreted to cover any third party who is acting for or on behalf of the Company and includes, but is not limited to, any agent, consultant, distributor, joint venture partner, representative, lobbyist, lawyer or accountant.

The requirements of the Policy are not designed to be exhaustive, but the Policy is intended to expand upon the provisions of the Company's Code of Business Conduct and Ethics and other Company policies and handbooks.

**II. POLICY STATEMENT**

It is the unalterable policy of the Company to comply with the provisions of the FCPA, UK Bribery Act and other applicable Anti-Corruption Laws.

**A. Anti-Bribery**

**Party City prohibits anyone acting on the Company's behalf from receiving or paying a bribe or giving, offering, promising, or authorizing the gift of money or anything of value to any person, including any Government Official, in order to improperly influence any act or decision of a person, or to otherwise gain an improper benefit for the Company.**

"Anything of value" includes not only cash and cash equivalents, but also gifts, entertainment, accommodations, and anything else of tangible or intangible value.

A "Government Official" may include, but is not limited to, any officer, employee, or those acting on behalf of any of the following:

- Government agencies, ministries, and administrative, judicial, or legislative bodies;
- Public international organizations, such as the United Nations;
- Businesses or other entities that are partially or wholly-owned or controlled by a government or governmental agency;
- Political parties, a candidate for foreign political office, or a foreign political campaign;

And

- Monarchies or members of royal families.

**B. Accurate Books and Records**

**Party City must create and maintain books, records and accounts that fairly and accurately reflect, in reasonable detail, all transactions and dispositions of assets conducted by the Company. No undisclosed or unrecorded fund or asset may be established or maintained for any purpose.**

Every officer, employee and agent of the Company is obligated by this and other Company policies, as well as by the FCPA, to keep books, records and accounts that accurately and fairly reflect all transactions and dispositions of Company assets. All transactions must be accurately recorded in the Company's books and records so as to reflect their true purpose.

**C. Mandatory Compliance and Policy Implementation**

Compliance with this Policy is mandatory. Failure to comply with this Policy can result in civil and criminal penalties and reputational damage to the Company. Any director, officer, or employee of the Company who violates this Policy, who directs another to violate this Policy, or who knowingly permits a subordinate to violate this Policy, will be subject to appropriate disciplinary action up to and including termination. Any Business Partner who violates this policy or whose subcontractor violates this policy while working on behalf of the Company shall result in the Company taking appropriate action, up to and including termination of the Business Partner's relationship with the Company. In addition to termination, directors, officers, employees, and Business Partners who fail to comply with this Policy may be personally subject to civil and criminal enforcement actions.

The Company will maintain appropriate internal controls designed to prevent, detect and remediate bribery and recordkeeping violations. All officers and employees are

responsible for ensuring that Business Partners with whom they interact fully understand and comply with the Policy.

### **III. REPORTING**

Any officer, director, employee, or Business Partner who has information that this Policy has been violated or believes that he or she is being asked to pay a bribe, receive a bribe, or otherwise act in violation of this Policy must immediately report the event. Reports shall be made to the employee's supervisor or to the Company's Confidential Hotline (contact information below). If a supervisor receives a report of a violation of this Policy, he or she shall forward that report to the Confidential Hotline. Reports may be made anonymously through the Confidential Hotline.

No one who makes a good faith report will be subject to disciplinary action or retaliation for making the report. No retaliation means that if you report a concern in good faith, you cannot be subject to any adverse employment action, including separation, demotion, suspension, or loss of benefits because of the report. However, a reporter may be subject to disciplinary action for any violations of this Policy or any other Company policies.

### **IV. GIFTS AND HOSPITALITY EXPENSES**

The Gifts and Hospitality Procedures, attached as Appendix A, specifically outline the very limited circumstances when items of value can be given to, or received from, third parties. Business courtesies such as travel and entertainment expenses, meals, Company promotional items, and gifts of a nominal value may not be offered or received except in accordance with this Policy and the Gifts and Hospitality Procedures.

### **V. FACILITATION PAYMENTS**

Facilitation payments (also referred to as "grease payments") are payments of de minimis value, oftentimes customary, intended to facilitate otherwise routine government action. They are not considered to be bribes under the FCPA, but they may be illegal under other applicable laws, including domestic anti-corruption laws, and are prohibited under the UK Bribery Act. Furthermore, it can be extremely difficult to distinguish a legitimate facilitation payment from an illegitimate bribe. **Accordingly, facilitation payments are prohibited by this Policy and any request for a facilitation payment or grease payment shall be immediately reported as if it were a request for a bribe payment.**

### **VI. EMERGENCY HEALTH AND SAFETY PAYMENTS**

Emergency Health and Safety Payments are payments made in response to a Government Official's demand for money or anything else of value under the threat of death, bodily harm, or injury to a person or the threat that a person may be unjustly and immediately jailed. In such cases, the payment demanded may be made without prior approval. Payments to prevent economic harm or the loss of business to the Company are not Emergency Health and Safety Payments.

Emergency Health and Safety Payments of any amount must be reported immediately to the officer's, employee's or Business Partner's immediate supervisor within the Company and to the Confidential Hotline.

### **VII. POLITICAL CONTRIBUTIONS**

No funds or assets of the Company may be used for political contributions without obtaining prior written approval from the General Counsel. These prohibitions cover not only direct contributions, but also indirect assistance or support of candidates or political parties through the purchase of tickets to special dinners or other fund raising events, or the furnishing of any other Company goods or services to political parties or campaigns.

**VIII. "RED FLAGS"**

Certain situations arise that may indicate a potential violation of the FCPA, UK Bribery Act or other Anti-Corruption Laws. The following "red flags" are merely a representative list of the types of transactions that may suggest a potential violation. Although this Policy and other Company controls guard against many of the scenarios below, Company personnel should always be alert to signs that a transaction is "wrong."

1. **PAYMENTS GREATER THAN "NORMAL" AND PAYMENTS FOR UNCLEAR PURPOSES.** These may be finders' fees, agents' fees or payment for goods or services which are more than seems to be appropriate or more than is stipulated in the contract with the third party. Payment for goods or services where there is insufficient detail as to the purpose of the payment is a red flag.
2. **THIRD-PARTY PAYMENTS.** Payments of money to persons outside the normal scope of the transaction. This includes payments made to accounts or persons in third countries. There may be reasonable explanations for making third-party payments, but such reasons must be documented and approved before such payments are made.
3. **LARGE BONUSES.** Although not inherently illegal, large bonuses which are success-based require careful scrutiny since the recipient of such a bonus may be tempted to share a portion of the bonus with an individual in a position to influence the Company obtaining or retaining business or any other improper advantage in the business of the Company.
4. **OVER-INVOICING.** Invoices that are "padded", higher than normal, or inadequately documented as to products or services delivered or received compared to prices charged or paid can be a sign that money is being siphoned for inappropriate uses. In addition to an auditing concern, such invoices can be a sign of corruption problems as well.
5. **LACK OF STANDARD INVOICES.** Abbreviated, "customized" or non-industry standard invoices can be an indication of efforts to hide or disguise payments for unauthorized purposes. Insist on standard invoices (and understand what they are) or demand a satisfactory and credible explanation for any variations.
6. **UNUSUAL CREDITS GRANTED TO NEW BUSINESS PARTNERS OR OTHER THIRD PARTIES.** Pre-payments, extensions of credit and cash advances to new and unfamiliar business partners or other third parties must be avoided. Such conditions are sometimes a sign that money must be placed in the hands of local officials before an order can be completed.
7. **CHECKS DRAWN TO "CASH".** Any transaction that is not adequately documented as to its true commercial purpose could not only indicate a corruption problem, it could also create problems for the Company with respect to its accounting standards and record-keeping obligations. Carefully, clearly, and accurately document all payments to or from Business Partners.
8. **SECRECY.** A request by a Business Partner that its relationship with the Company be kept secret is a red flag of a potential corruption problem. The Company should avoid doing business with any Business Partner that requests that its relationship with the Company be kept secret.
9. **SPECIAL RELATIONSHIPS.** Where a Business Partner has a special relationship to the foreign government, such as if the local party's relatives, partners, owners, principals, or staff members are officials, officers, or representatives of a foreign government or political party



**HALLOWEEN CITY**

## Section - 1

or candidates for political office, there is a greater potential for a violation of Anti-Corruption Laws.

### **IX. BUSINESS PARTNER DUE DILIGENCE**

Business Partners present heightened anti-corruption risk. You are expected to contact [compliance@partycity.com](mailto:compliance@partycity.com) if you are contemplating entering into a relationship with a Business Partner that will operate outside of the United States and Canada, so that the Company can work with you to ensure that the third party undergoes appropriate due diligence.

Party City's Compliance organization will direct all due diligence activities for vendors operating outside of the U.S. and Canada. Upon completion of vendor due diligence, the General Counsel's office will oversee the negotiation of a written contract with the vendor. Under no circumstances may a business unit sign a contract with a third-party vendor without the approval of the General Counsel's office. Business Units are expected to stay in close communication with the Compliance organization and the General Counsel's office throughout the due diligence process and shall promptly provide information as requested.

### **X. THE CONFIDENTIAL HOTLINE**

The Company's Confidential Hotline may be accessed in various languages through the channels below.

**For Wholesale and Manufacturing units/offices: 1 (800)405-8943 or [www.reportlineweb.com/partycity](http://www.reportlineweb.com/partycity)**

**For Retail stores/corporate office: 1 (888)270-5937 or [www.reportlineweb.com/partycity](http://www.reportlineweb.com/partycity)**

## **APPENDIX A**

### **Gifts and Hospitality Procedures**

#### **a. Introduction**

All gifts and hospitality (including meals, entertainment, and travel expenses) offered or received on behalf of Party City Holdings Inc. and/or its respective affiliates and subsidiaries (collectively, "Party City" or "the Company") must be directly related to a legitimate business purpose. Gifts and hospitality in all cases must be reasonable in amount and must be offered or received in good faith only in direct relation to: (1) the promotion, demonstration or explanation of company products or services; (2) the execution or performance of a contract with a third party, including a foreign government or agency thereof; or (3) compliance with law. Any gifts or hospitality provided by or on behalf of the Company must be lawful under applicable local law. In no event may any gift or hospitality be offered, provided, or received in return for any improper favor or benefit to the Company or its Business Partners, and no gifts or hospitality should be provided that creates even the appearance of impropriety or otherwise being unduly lavish.

*Note:* Frequency of providing gifts and hospitality must be carefully monitored, as the cumulative effect of frequent gifts and hospitality may give rise to the appearance of impropriety. The frequency of gifts and hospitality provided must always be of a customary or reasonable amount. Refer any questions that arise relating to the appropriateness of repeated gifts and hospitality to [compliance@partycity.com](mailto:compliance@partycity.com).

No Company employee may be reimbursed for expenses relating to Gifts and Hospitality provided to third parties without appropriate supporting documentation (such as itemized receipts, invoices, and proof of payment).

**b. Meals and Entertainment**

Meals and entertainment offered to or received from persons who have a business relationship with Party City are generally acceptable so long as the meal or entertainment is: (1) reasonable in value; (2) appropriate to the business relationship; (3) does not create an appearance of impropriety; and (4) provided in the presence of a representative from Party City (i.e. Party City is not paying for meals and entertainment for which it has no direct involvement). Note that many foreign jurisdictions have laws restricting entertainment and meals provided to Government Officials.

Refreshments and meals of reasonable value and otherwise in accordance with these Gifts and Hospitality Procedures, which are furnished in connection with trade shows, association meetings, official governmental functions, or ceremonial, commemorative or celebratory functions, are permissible. For such events or occasions to which foreign Government Officials are invited, notification of such events shall be made in writing to [compliance@partycity.com](mailto:compliance@partycity.com) at least 15 days in advance of such event, or some other reasonable amount of time as circumstances allow. The notification shall generally describe the event, the per person cost of the refreshments and meals and mementos offered, and any other relevant aspects of the event.

**c. Travel Expenses**

All travel expenses provided by the Company to any person, including, but not limited to a foreign Government Official, including the costs of transportation, lodging, meals and entertainment in connection with business travel, must be reasonable and bona fide, based on a legitimate business purpose and provided in the normal course of business. In addition, all such travel expenses must be permissible under the applicable local laws and regulations and must be limited to what is necessary to meet the business need.

The following rules apply to all travel expenses provided by the Company to Government Officials:

- The government entity or agency, and not the Company, must select the invitees;
- The Company shall not pay for the travel of anyone not directly involved in the legitimate business purpose of the trip (i.e. the family or friends of a Government Official);
- The travel or transportation must be directly between the Government Official's residence or office and the business location to which the Government Official is traveling;
- Neither the Company nor anyone acting on the Company's behalf may pay for side trips, shopping excursions, or leisure activities; and
- Providing cash, gift cards, and cash equivalents are prohibited.

In no case will payment or reimbursement for travel expenses be made directly to the individual for whom the expense was incurred. Such payment or reimbursement shall be made, whenever possible, directly to the travel vendor (hotel, airline) or otherwise to the corporation, government or organization involved.

Per diem payments are similarly prohibited, except where expressly provided for in a written contract with a customer or when required by law. In such case, per diem payments shall be paid strictly in accordance with the contract requirements or as required by law. Any such payment shall be made by check, rather than cash. Whenever feasible, the check for per diem payments should be made payable to the customer, rather than to any individual. Any such per diem payment shall always be accompanied by appropriate documentation accurately recording the amount and nature of the payment in accordance with the contract requirement.



**d. Gifts**

All gifts provided on behalf of Party City must comply with all of the following conditions:

1. The gift is not in the form of cash, gift cards, or any cash equivalent;
2. The gift is made as a courtesy;
3. The cost of the item is reasonable and its ceremonial value exceeds its intrinsic value;
4. The gift is given openly rather than in secret;
5. The gift is permissible under all applicable laws (including local laws);
6. The gift is not part of systematic or a long-term pattern of gift-giving; and
7. The gift is duly recorded as such in the Company's books and records.

Whenever possible and appropriate, the gifts provided should bear the Company logo. Gifts valued at \$100 or more must have the prior approval of the General Counsel's office (which may be reached via [compliance@partycity.com](mailto:compliance@partycity.com)) before being provided. Whenever appropriate, a gift should be made to the customer organization or to a governmental agency, and not to an individual.

**e. Providing Hospitality to Relatives of Business Contacts Generally Not Permitted**

Prior written approval by the Compliance organization (which may be reached via [compliance@partycity.com](mailto:compliance@partycity.com)) is required for any hospitality benefitting the spouse and/or other relatives of a customer or Business Partner, except as provided below.

Under no circumstances will the Company provide hospitality for relatives of a Government Official or any other person accompanying a Government Official who does not have a legitimate business interest in the planned activities.

**XI. QUESTIONS**

Questions about this Policy or the Company's anti-corruption obligations shall be directed to [compliance@partycity.com](mailto:compliance@partycity.com)

**Anti-Bribery Policy**

PCHI does not tolerate bribery, corruption, or unethical practices of any kind. The Company strictly prohibits anyone acting on our behalf (whether directly or indirectly) from receiving bribes or paying, offering, promising, or authorizing money or anything of value to improperly influence anyone (collectively "Improper Payments"). This Policy prohibits Improper Payments of any type or amount as well as "facilitation payments" (payments made to officials to secure or expedite the performance of a routine or necessary action or level of service). Vendors agree to comply with all applicable anti-bribery and corruption laws. Our vendors may be held responsible if their subcontractors violate this policy.

Our vendors MUST NOT:

- give, authorize, offer or promise any Improper Payment to any third party (including companies, partnerships, government agencies, government officials, political campaigns and candidates, or employees of government-owned entities);
- give, authorize, offer or promise any Improper Payment to any person employed or engaged by PCHI; or
- seek, request or obtain any Improper Payment from PCHI or any third party.

Our vendors MUST:

- maintain adequate controls and procedures designed to (i) ensure compliance with all applicable anti-corruption laws and (ii) ensure that the vendor's books and records are accurate and kept in accordance with Generally Accepted Accounting Principles;

**Section - 1**

- maintain appropriate “whistle-blowing” procedures so that employees of the vendor are encouraged and able to report known or suspected acts of bribery or corruption;
- promptly inform PCHI in the event of any breach of the Policy at [compliance@partycity.com](mailto:compliance@partycity.com); and
- cooperate with investigations carried out by PCHI into actual or suspected misconduct, including violations of anti-bribery regulations, and grant representatives of PCHI access to records and employees for purposes of investigating actual or suspected misconduct.

**Conflict Minerals**

On August 22, 2012, the U.S. Securities and Exchange Commission adopted what is known as the "Conflict Minerals Rule." The Rule requires U.S. public companies to conduct diligence on the use and source of "conflict minerals" in manufactured products and, depending upon the results of that diligence, to make certain specified disclosures concerning the use and source of those minerals.

This new law is designed to prevent financing of conflict, through trade in certain materials, by armed groups who conduct human rights abuses in the Democratic Republic of Congo (DRC) and surrounding countries. The new law requires companies who currently file reports with the SEC under Sections 13(a) or 15(d) of the Exchange Act to report to the SEC if any products that they manufacture or contract to manufacture contain four chemicals (3T + Gold) and their derivatives from 10 countries in Africa. The Conflict Minerals are as follows:

1. Cassiterite (commonly used for Tin in alloys, tin plating and circuit solder)
2. Columbite-Tantalite (commonly used for Tantalum in electronic components)
3. Gold (commonly used in jewelry and electronics)
4. Wolframite (commonly used for Tungsten in metal wires, electrodes and electronic contacts)

The covered countries include the following:

- a. Democratic Republic of Congo
- b. Angola
- c. Burundi
- d. Central African Republic
- e. Republic of Congo
- f. Rwanda
- g. South Sudan
- h. Tanzania
- i. Uganda
- j. Zambia

**Trade Sanctions Compliance**

- Vendors must comply with all applicable trade sanctions regulations administered by the U.S. Department of Treasury’s Office of Foreign Assets Control, the U.S. Department of State, the United Nations Security Council, the European Union, and any other relevant sanctions authority (collectively, “Sanctions”).
- Vendors are required to immediately notify the Company at [compliance@partycity.com](mailto:compliance@partycity.com) if any of their respective directors, officers, employees, or agents is a person that is, or is owned or

controlled by persons that are: (i) the subject of Sanctions or (ii) located, organized or resident in a country or territory that is the subject of Sanctions.<sup>1</sup>

## Social Compliance

- Vendors must comply with the PCHI's Supplier Code of Conduct, included in **Section 1a**. This Code sets forth requirements for suppliers of our products with respect to labor standards and working conditions. The principles embodied in our Code are designed to be consistent with core conventions of the International Labor Organization (ILO), the specialized agency of the United Nations focused on global labor standards, codes set forth by key labor standards organizations, as well as codes required by brands, retailers, and licensors who are customers of PCHI.
- PCHI's Supplier Code of Conduct code should be posted and/or made available to all employees in the local language;
- Adherence by a supplier to this Code also means complying in all respects with the "WRAP (Worldwide Responsible Apparel Producers) -Universal Code", **SEDEX 4 Pillar** or any comparable, generally recognized equivalent, and providing to PCHI, upon request, an acceptable independent, third-party audit of the facility and their level of compliance with the PCHI Supplier Code of Conduct.

PCHI reserves the right to take all appropriate measures, in accordance with applicable terms and conditions, against any vendor or supplier that fails to comply with this code. (Please refer to **Section 6b** for social compliance requirements. Examples of acceptable audits include ICTI, WRAP, SA8000, SEDEX, BSCI, WCA, Better Work Programme, or other equivalent audit standard put forth by major retailers, licensors, or consumer brands.) **A current certification audit (done by an independent, 3<sup>rd</sup> Party Auditing firm, including, but not limited to, Intertek, SGS, Eurofins, Bureau Veritas, HAP (Hire a Partner), or Elevate) that incorporates ILO standards and/or those standards of the applicable retail customer, license, brand, or other 3<sup>rd</sup> party is required as part of PCHI's factory approval process and will be requested and/or verified, as applicable. Audits, and other documentation, shall be provided upon request to ensure compliance with the Uyghur Forced Labor Prevention Act, including.**

## Sustainability

PCHI is committed to supporting conditions under which people and nature can productively co-exist through a collection of mutually beneficial measures. The following summarizes some of the daily measures that PCHI takes to encourage global sustainability among its suppliers and customers:

- Energy, land, air, and water resource usage efficiency in facilities and processes
- Environmental conservation and compliance
- Increased use of recycled and recyclable materials in product and packaging
- Responsible sourcing of timber products, including FSC-certified material
- Reduction of packaging materials
- Use of renewable resources, such as sugar cane, corn, and bamboo
- Minimization of waste at company-owned facilities

---

<sup>1</sup> A list of the U.S. Government's current sanctions programs can be found at: <https://www.treasury.gov/resource-center/sanctions/programs/pages/programs.aspx>.



## Section - 1

As a supplier to PCHI, we encourage you to develop products and packaging that benefit the environment and keep us informed of any sustainability measures or programs which would have as large a positive impact as possible.



**HALLOWEEN CITY**



## Section - 2

### Terms and Conditions

The following Terms and Conditions are part of the **Vendor Standards Manual** ("VSM") and are fully incorporated herein. Please note that once executed by Vendor, the **VSM** including but not limited to these Terms and Conditions, shall apply and shall continue indefinitely until amended or terminated.

**1. Definitions:** As used herein, the following terms shall have the following meaning: (a) "Order" means a purchase order or an order effectuated through Electronic Data Interchange Transmission (EDI) or any other means, which orders shall be deemed to include, in either event, these Terms and Conditions and (b) "Merchandise" refers to the goods, products, packaging, promotional materials including advertising, supplies, parts, assemblies, specifications, services or other items constituting the subject matter of the Order which are to be furnished by the Vendor to Amscan Inc. (Amscan), Party City Corporation or their franchisees, affiliates or subsidiaries hereunder. References to "THE COMPANY" include Party City Holdings, Inc ("PCHI"), all wholesale and retail subsidiaries of PCHI, including but not limited to, Amscan Inc., Anagram International, Party City Corporation, Party America, Halloween City, and any franchisees affiliated with any of the foregoing.

**2. Warranties:** Vendor represents and warrants to THE COMPANY, in addition to all warranties expressed or implied by law, that the Merchandise and its use, importation, design, construction, assembly, production, shipment, sale, packaging, labeling, packing, advertising, instructions and warnings or lack thereof and other printed matter furnished or authorized by Vendor, shall (a) be free from defects in design, workmanship and/or materials, including, without limitation, such defects as could create a hazard to life or property; (b) be suitable for end use; (c) be manufactured, packed for shipment, marked with the country of origin or other information required by law or regulation and where required, be registered, tested and certified to conform with all applicable federal, state and local laws, and the laws of any United States Commonwealth or any country or territory where THE COMPANY does business, including the Commonwealth of Puerto Rico, and all orders and regulations promulgated thereunder; (d) (i) not infringe or encroach upon any party's personal, contractual or proprietary rights, including patent, designing trademark, tradename, servicemark, copyright, right of privacy or publicity or trade secret rights; collectively hereafter ("Proprietary Rights") or (ii) not have been or be the subject of any allegation by any party alleging violation of such party's Proprietary Rights; (e) not violate or breach any agreement that Vendor may have with a manufacturer or distributor; (f) conform to all specifications, guidelines, other descriptions and delivery dates set forth or incorporated in the Order and all articles accepted by THE COMPANY as merchandise samples; (g) possess all performance qualities and characteristics claimed in advertisements or representations made, issued or authorized by Vendor; (h) be in conformity with the Federal Food, Drug and Cosmetics Act, the Federal Trade Commission Act, the Consumer Product Safety Improvement Act or any other federal, state or local law, and the laws of any United States Commonwealth or any country or territory where THE COMPANY does business, including the Commonwealth of Puerto Rico, and all orders and regulations promulgated thereunder; (i) be properly stamped, tagged, labeled, or marked with such information as may be required by any applicable law, regulation or order or by THE COMPANY; (j) be well within any expiration date indicated on the packaging of the Merchandise; (k) have been stored under proper conditions to preserve the quality of the Merchandise; and (l) meet all applicable requirements of all applicable United States federal, state and local laws and regulations and of all applicable laws and regulations of jurisdictions outside the United States. Vendor also represents and warrants that (m) the weights, measures and sizes of all Merchandise shall be as represented and conform to all standards, regulations and requirements of any federal, state or local governmental authorities having jurisdiction, and any United States Commonwealth or any country or territory where THE COMPANY does business, including the Commonwealth of Puerto Rico; (n) the prices, terms and conditions of sale hereunder and any discount, rebate or allowance for advertising or otherwise granted by Vendor in connection herewith are not in violation of the Robinson-Patman Act and are in compliance with all applicable laws and regulations; (o) have raw materials, packaging, and all components of the finished product that are free of radiation or other contaminants which have adverse effects on human health or environment; and (p) no forced labor or child labor shall be or was utilized in connection with the manufacture of the merchandise. Vendor's representations and warranties herein shall survive the delivery of Merchandise to THE COMPANY and any resale of Merchandise by THE COMPANY.



**HALLOWEEN CITY**



## Section - 2

**3. Product Compliance Tests:** For those items provided directly to the retail entities of THE COMPANY, Vendor for PCHI retail entities, at its sole cost and expense, shall perform, or cause to be performed, all tests on the Merchandise required by the Customer Product Safety Commission and any other federal, state and local laws, or the laws of any United States Commonwealth or any country or territory where THE COMPANY does business, including the Commonwealth of Puerto Rico, and shall maintain for a period of not less than three (3) years certificates indicating that all applicable tests have been administered and passed. Such tests shall be conducted on an annual basis or sooner as may be required by any applicable law, rule or regulation, by Intertek Testing Services (ITS), Modern Testing Services (MTS), MSR Laboratories (MSR) or equivalent CPSC approved laboratories or OSHA National Approved Testing Laboratory for electrical safety, including but not limited to UL, ETL, CSA. Vendor shall make available and furnish at THE COMPANY's request, copies of such certificates and shall permit THE COMPANY, or any person or persons authorized by THE COMPANY, to inspect and make copies of all records maintained by Vendor in connection with such tests. In the event Vendor does not test its products to applicable and/or mandatory federal, state or local standards, THE COMPANY may test those products and either withhold payment as a result of such testing or chargeback the cost of such testing to the Vendor. For those items provided to Amscan, for purposes of wholesale distribution, Amscan shall, until further notice, perform, or cause to be performed, all tests on the Merchandise required by the Consumer Product Safety Commission and any other federal, state and local laws, or the laws of any United States Commonwealth or any country or territory where THE COMPANY does business, Amscan shall pay for production sample testing for the first sample run and all other production runs as requested. However, if the product fails testing, Vendor will need to pay for all fees and costs associated with the failed testing report, including, but not limited to, costs of the failed testing, rework, disposal, labeling, packaging, sampling, inspection, internal evaluation, and each subsequent test on that item until it receives a passing result.

**4. Registration and License Numbers:** Vendor shall obtain and provide to THE COMPANY any and all registration numbers, license numbers, or the like, required by any federal, state, local, foreign, provincial or territorial governmental agency or authority having jurisdiction over the Merchandise type in question, the sale of such Merchandise, and/or any claims made regarding the Merchandise or any of its qualities. In the event vendor is working only with Amscan Inc., the registration numbers, license numbers and the like shall be sent to Amscan Inc., 80 Grasslands Road, Elmsford, New York 10523, Attention: Vendor Relations. In the event vendor is working only with Party City Corporation, registration numbers, license numbers and the like shall be sent to Party City Corporation, 25 Green Pond Road, Suite #1, Rockaway, NJ 07866, Attention: Vendor Relations. In the event vendor is working with both Amscan Inc. and Party City Corporation, registration numbers, license numbers and the like shall be sent to Amscan Inc., 80 Grasslands Road, Elmsford, New York 10523, Attention: Vendor Relations.

**5. Material Safety Data Sheet:** Vendor shall provide THE COMPANY a Material Safety Data Sheet ("MSDS") as required by THE COMPANY or pursuant to the Occupational Safety and Health Act (OSHA) and any other federal, state, or local law, regulation or order prior to the delivery of Merchandise particularly including, but not limited to, those products that the end-user could have dermal, oral, respiratory or other bodily exposure to. An MSDS, if required, shall also be included with the first delivery of any Merchandise to each of THE COMPANY's Stores. In the event vendor is working only with Amscan, the registration numbers, license numbers and the like shall be sent to Amscan Inc., 80 Grasslands Road, Elmsford, New York 10523, Attention: Vendor Relations. In the event vendor is working only with Party City Corporation, registration numbers, license numbers and the like shall be sent to Party City Corporation, 25 Green Pond Road, Suite #1, Rockaway, NJ 07866, Attention: Vendor Relations. In the event vendor is working with both Amscan and Party City Corporation, registration numbers, license numbers and the like shall be sent to Amscan Inc., 80 Grasslands Road, Elmsford, New York 10523, Attention: Vendor Relations.

**6. Terms must be in Writing:** No terms or conditions in any acceptance, acknowledgment, invoice or other document submitted by Vendor that are in conflict with, different from, or in addition to these Terms and Conditions, nor any modification of the Order, shall be binding upon THE COMPANY unless agreed to in writing by a duly authorized representative of THE COMPANY.



**HALLOWEEN CITY**



## Section - 2

### 7. **Purchase Order:**

- (a) An Order, when in the form of a written purchase order, shall constitute an offer on the part of THE COMPANY upon these Terms and Conditions and shall become a binding contract between THE COMPANY and Vendor upon Vendor's acceptance of the Order by:
- (1) signing one copy of the Order and returning it to THE COMPANY; or
  - (2) returning a signed written confirmation of the Order to THE COMPANY; or
  - (3) delivering to THE COMPANY, in accordance with the Terms and Conditions as set forth in the Order, all or any part of the Merchandise ordered; or
- (b) An Order, when in the form of an EDI transmission or email, shall constitute an offer on the part of THE COMPANY upon these Terms and Conditions and upon any terms and conditions indicated in the EDI transmission and shall become a binding contract between THE COMPANY and Vendor upon Vendor's acceptance of the Order by:
- (1) delivering to THE COMPANY, in accordance with the Terms and Conditions as set forth in the Order, all or any part of the Merchandise ordered; or
  - (2) electronically acknowledging receipt of the Order coupled with failure to reject the Order within two (2) business days following its receipt; or

**8. Prices:** The prices specified in the Order are not subject to any additional charges for packing or preparation for shipment due to increased costs of operation, or because of any taxes or excises levied on processors, manufactures, wholesalers or otherwise. The Order shall not, without written authorization from THE COMPANY, be fulfilled at higher prices than specified therein, or, if the Order is not priced, at prices higher than last charged or quoted to THE COMPANY for Merchandise described therein. Vendor agrees that any price reduction made to the Merchandise described in the Order prior to the delivery of such Merchandise to THE COMPANY shall be applicable to the Order. Whenever price is dependent upon cubic density, such density shall be specified by Vendor.

**9. Changes to an Order:** THE COMPANY may at any time make changes in written, electronic or facsimile form to any Order, including changes in the drawings or specifications, methods of shipment, warranties, packing, or time or place of delivery at any time prior to 30 days before the start ship date for the Merchandise. If such changes result in an increase or decrease in cost of, or time required for the performance of the Order, an equitable and reasonable adjustment shall be made in the price, delivery schedule or both. If such changes result in an increase in cost or time which is unacceptable to THE COMPANY, then THE COMPANY in its sole discretion may cancel its request for such changes.

**10. Timeliness:** Time is hereby made of the essence on the Order. If delivery of Merchandise is not completed by the date set by THE COMPANY, THE COMPANY reserves the right, without liability and in addition to its other rights and remedies at law, in equity or under the terms of the Order, to purchase elsewhere and hold Vendor liable for any additional loss, cost, damage or expense incurred thereby. Vendor shall pay any loss, cost, damage or expense resulting from the untimely receipt of the Merchandise ordered. Vendor shall notify THE COMPANY immediately if it is unable to ship timely. THE COMPANY shall have the right to refuse any goods with untimely delivery and to cancel the balance of the Order for any part of the goods due after untimely delivery of any installments. By accepting the untimely delivery of any installment, THE COMPANY shall not be bound to accept future shipments nor be deprived of its right to return Merchandise already accepted nor to claim damages for untimely delivery.

**11. Order Postponement:** THE COMPANY shall have the right to require Vendor to postpone shipment of Merchandise or suspend work covered by the Order and Vendor shall take all reasonable steps or minimize costs during such suspension. Equitable adjustment shall be made to the price, delivery schedule or other provisions affected by the suspension, provided that the claim for equitable adjustment is made within thirty (30) days after THE COMPANY directs the continuation of the work.

**12. Order Termination:**

- (a) THE COMPANY may terminate an Order, or any part thereof, by notice to Vendor under any of the following circumstances:
- (1) If Vendor fails to comply with any provisions of the Order.
  - (2) If Vendor becomes insolvent or makes a general assignment for the benefit of creditors or files or has filed against it a petition of bankruptcy or for reorganization or pursues any other remedy under any other law relating to the relief for debtors or in the event a receiver is appointed for Vendor's property or business.
  - (3) If THE COMPANY receives notice of an allegation of Proprietary Rights infringement or believes that there may be an infringement of Proprietary Rights regarding the Merchandise that is the subject matter of the Order.

In the event of such termination, in addition to all other rights and remedies THE COMPANY may have at law, in equity or under these Terms and Conditions, THE COMPANY may purchase or manufacture similar Merchandise and/or require Vendor to transfer title and deliver to THE COMPANY any and all property produced or procured by Vendor under the Order and Vendor shall be liable to THE COMPANY for any excess cost to THE COMPANY.

- (b) In addition to THE COMPANY's right to terminate an Order for cause pursuant to Paragraph 12 (a) above, THE COMPANY may terminate an Order in whole or in part at any time upon notice to Vendor. On receipt by Vendor of such notice, Vendor shall, to the extent specified therein, stop work thereunder and the placement of work with subcontractors, terminate work under subcontracts outstanding thereunder, and take any necessary action to protect property in Vendor's possession in which THE COMPANY has or may acquire an interest. In such event, THE COMPANY shall pay to Vendor the amounts due for supplies delivered and accepted or services completed in accordance herewith prior to the effective date of termination.
- (c) Any termination by THE COMPANY whether for cause or otherwise, shall be without prejudice to any claims for damages or other rights of THE COMPANY against Vendor.
- (d) Vendor shall continue performance of the Order to the extent not terminated.

**13. Right to Refuse Merchandise:** THE COMPANY shall have the right to refuse Merchandise not in accordance with specifications or industry standard or breaches of any warranties contained herein, or which is different in quality or quantity from that ordered, or which is shipped otherwise than as specified under the Order or which is believed by THE COMPANY to violate a third party's Proprietary Rights or is alleged to violate a third party's Proprietary Rights. THE COMPANY may, at its sole discretion, either return rejected Merchandise or hold same at Vendor's risk and expense and may, in either event, charge the Vendor with the cost of transportation, shipping, unpacking, examining, repacking, storing, reshipping, disposal and other like expenses as well as the right to chargeback Vendor for the loss of sales and punitive damages for any harm to THE COMPANY's business reputation as a result of any breach of warranty hereunder. For purposes hereof, the "right to chargeback" shall mean vendors payment to THE COMPANY of an amount equal to the sum of lost wholesale and retail profit, as applicable, defined as follows: i) for wholesale- 100 percent of the lost profit based on the difference between the total carrying cost and the average wholesale selling price at the time of loss for the affected inventory and ii) for retail- 100 percent of the lost profit based on the difference between the average wholesale selling price and the average retail selling price at the time of loss for the affected inventory. For "Everyday" items, the lost retail profit shall be based on 80 percent of the inventory. If Vendor fails to accept Merchandise returned by THE COMPANY, then THE COMPANY shall have the right to dispose of such Merchandise by any means. If within thirty-six (36) days after a request by THE COMPANY for direction regarding disposition of rejected Merchandise, Vendor does not respond to THE COMPANY, THE COMPANY shall have the right to dispose of the Merchandise by any means. Acceptance of any prior shipments contrary to the Order shall not be considered a waiver of THE COMPANY's right to return any or all of the Merchandise and receive full credit therefore. Authorization for substitution of style, color, size, quantity or a combination thereof, is permitted only upon the written, signed and





**HALLOWEEN CITY**



## Section - 2

dated consent of THE COMPANY. Any claims for defective Merchandise, shortages, returns, damages, or other claim of set off asserted as a result of Vendor's failure to comply with these Terms and Conditions made by THE COMPANY will be charged back to Vendor and the amount thereof deducted from payments to be made to Vendor or, alternatively, will be promptly refunded to THE COMPANY.

**14. Right to Return Merchandise:** THE COMPANY may at any time after delivery of the Merchandise (and whether or not the same has been accepted by THE COMPANY) return all or part of the Merchandise if any part is found to be in a damaged or defective condition or has breached any warranties herein or if believed by THE COMPANY to violate a third party's Proprietary Rights, or if alleged to violate a third party's Proprietary Rights. Vendor shall refund to THE COMPANY in full the price paid by THE COMPANY for such returned Merchandise as well as the right to chargeback. Any Merchandise so returned shall be at Vendor's risk and expense.

**15. Right to Cancel:** In addition to any other remedies available to THE COMPANY under this Agreement or applicable law, upon Vendor's breach of this agreement or any Order, THE COMPANY at its option and without liability to Vendor, may forthwith cancel any unshipped portion of any Order.

**16. Advance Shipment:** If THE COMPANY accepts any advance shipment (other than requested by it) under any Order, payment terms on such shipment shall be computed from the prescribed shipping date. Terms on shipments not in advance shall begin when Merchandise is received by THE COMPANY, except that invoices for Merchandise received on and after the 25<sup>th</sup> of the month will be considered received as of the first of the following month.

**17. Shipping Charges:** Vendor shall pay all charges for packing, crating and shipping unless THE COMPANY expressly agrees to pay such charges.

**18. Freight on Board THE COMPANY:** Except for Freight on Board (F.O.B.) origin Orders, title to the Merchandise ordered hereunder, as well as all risks of loss therefore, shall remain in Vendor until the Merchandise reaches the directed point of destination and is signed for by THE COMPANY's authorized representative. For F.O.B. origin Orders, title and risk of loss shall remain in Vendor until the Merchandise is received by the carrier designated by THE COMPANY.

**19. Additional Expenses:** Unless THE COMPANY otherwise agrees in writing, any additional expense resulting from any delay, partial shipment, early shipment, change of routing, variation of cubic density, change of pack or other failure by Vendor to comply with the terms of this Agreement or the applicable Order shall be paid by Vendor.

**20. Right to Deduct Monies Owed:** THE COMPANY reserves the right to deduct from any amount due Vendor for Merchandise, ordered any amount Vendor owes THE COMPANY with respect to any claims of any nature whatsoever in favor of THE COMPANY against Vendor, whether or not related to the Order and whether now existing or hereafter arising, and any assignee of the Vendor's rights to payment hereunder shall be subject to THE COMPANY's rights under this paragraph.

**21. Right to Withhold Payment:** THE COMPANY reserves the right to withhold any payments due Vendor, without penalty or forfeiture, until all disputes whether or not related to the Order and whether or not existing or arising in the future between THE COMPANY and Vendor, are settled.

**22. Bankruptcy:** Any sums payable to Vendor shall be subject to all claims and defenses of THE COMPANY, and THE COMPANY may deduct and set off against any such sums all present and future indebtedness of Vendor to THE COMPANY. In addition to the foregoing set off rights between THE COMPANY and Vendor, THE COMPANY shall be entitled to set off all obligations it owed Vendor, Vendor's divisions, departments, subsidiaries, affiliates and other related entities (the "Related Entities") against any claims THE COMPANY may have against any or all of the Related Entities, as if: (i) a debt existed from THE COMPANY to the Related Entities or any one of them, (ii) THE COMPANY had a claim against the Related Entities or any one of them, and (iii) the debt and the claim are mutual obligations. For the purpose of this section, Vendor and each of the Related Entities expressly consent to



**HALLOWEEN CITY**



**Section - 2**

the set off rights afforded herein as they affect the Related Entities. The parties further agree that these set off rights will be applicable and fully enforceable in the event Vendor or any of the Related Entities commence a voluntary bankruptcy proceeding or become the subject of an involuntary bankruptcy petition under Title 11 of the United States Code. THE COMPANY shall provide a copy of the deduction statements for debt it has taken against the Vendor's account as a result of any deductions or set offs. Vendor shall be deemed to have accepted each such deduction or set off unless Vendor, within 90 days of receipt of the deduction statement notifies THE COMPANY in writing as to why a deduction or set off should not be taken and provides documentation of the reason(s) given. THE COMPANY shall not be liable to Vendor for any related interest of late charges pending resolution of the contested set off. In the event that either a voluntary or involuntary bankruptcy petition is commenced by or against Vendor and/or any of the Related Entities under the Title 11 of the United States Code, or under any other federal or state law governing the reorganization, liquidation, assignment for the benefit of creditors, or other similar disposition of Vendor or the Related Entities, Vendor and the Related Entities unconditionally and irrevocably consent, to the relief from the automatic stay so as to allow THE COMPANY to exercise its rights and remedies under the Agreement, including but not limited to exercising its right of set off as set forth herein. In such event, Vendor and the Related Entities hereby agree that they shall not, in any manner, oppose or otherwise delay any motion filed by THE COMPANY for relief from the automatic stay. The provisions of this section constitute a material inducement for Vendor and THE COMPANY to enter into any agreement.

**23. Intellectual Property:** All Merchandise, Proprietary Rights and Confidential Information which are supplied by THE COMPANY or which are distinctive of THE COMPANY's private label or licensed label merchandise or which contain any Proprietary Rights of THE COMPANY or which are created at the request of THE COMPANY (collectively "Special Features") shall be the property of THE COMPANY as "works-made-for-hire" ("Licensed Material") shall be used by Vendor only for THE COMPANY for THE COMPANY's benefit, provided, however, that in the event that Vendor is deemed to have any rights in the Licensed Material, Vendor hereby assigns to THE COMPANY absolutely and exclusively all of Vendor's right, title and interest in the Licensed Material, throughout the Universe in perpetuity (or for the full time period otherwise permitted under local law), in all languages. In the event any right, title, or interest in any of the Licensed Material is not transferred to THE COMPANY by operation of assignment, Vendor hereby grants to THE COMPANY or its designee an exclusive, transferable, sublicensable, Universe-wide, paid-up, royalty-free and irrevocable license to use, exploit and sublicense any and all Licensed Material and related intellectual property rights, whether or not copyrightable, patentable or otherwise protectable under applicable Law, in perpetuity (or for the full time period otherwise permitted under local Law), in all languages. All goodwill accruing shall be for and inure to the benefit of THE COMPANY. All intellectual property associated with Merchandise created by Vendor which includes Special Features, THE COMPANY Proprietary Information or which was created at the request of THE COMPANY shall be and hereby is assigned to THE COMPANY. THE COMPANY may use Special Features as it sees fit on or with respect to goods manufactured by others. Merchandise with Special Features which is not delivered to THE COMPANY for any reason shall not be sold or transferred to any third party without THE COMPANY's prior written authorization, and unless and until all labels, tags, packaging and markings making use of the Special Features or otherwise identifying the Merchandise to THE COMPANY have been removed. Vendor shall defend, indemnify and hold THE COMPANY and its officers and shareholders, agents and employees, harmless from and against all costs, expenses, liabilities and losses reasonably incurred (including reasonable attorneys' fees and associated legal costs) arising out of any claim of any violation of personal or property rights based on, or in connection with, the actual sale, offer to sell, use or importation of any material, Merchandise, or any other thing used, created, supplied, manufactured, or obtained by Vendor in connection with Vendor's performance under this Agreement.

Upon the first to occur of: (1) the expiration or termination of your relationship with the Company or (2) upon written request from the Company, Vendor shall destroy any and all products and packaging which bears any trademark of the Company, including (without limitation), the trademarks "Amscan" and "Anagram" and, further, Vendor shall certify to the same upon request from time to time. The foregoing shall survive the termination or expiration of this Agreement.

As part of the PCHI Product Development process, PCHI aligns with its suppliers to develop Mold/Tool/Plates for our products. All Artwork, Proprietary Rights and Confidential Information which are supplied by PCHI or which



**HALLOWEEN CITY**

**Section - 2**

are distinctive of PCHI's private label or licensed label merchandise or which contain any Proprietary Rights shall be deemed the property of PCHI.

Vendors should take the following steps in the oversight of mold/tool/plates:

- Maintain a library of all PCHI Mold/Tool/Plates product both active and inactive.
- Provide a quarterly on hand list of Mold/Tool/Plates to the Product Directors with a C.C. to the PCHI Asia Merchandise Team (AMT).
- Bear responsibility for the maintenance and storage of all active Mold/Tool/Plates.
- Contact the appropriate Product Director at PCHI prior to disposing or destruction of any Mold/Tool/Plates.
  - For Everyday product, if no order is received on an item in a 12-month period, items should be sent to Product Directors to confirm disposal.
  - For Seasonal product, if the Vendor has not received any new orders since 1 week after the seasonal ex-factory date from the previous year, items should be sent to the Product Director to confirm disposal.
- Receive written confirmation from the appropriate Product Director Mold/Tool/Plates can be disposed. **THERE ARE NO AUTOMATIC DISPOSALS.** Directors **MUST** confirm.
- If you are unfamiliar with who the appropriate Product Director is as it relates to the specific Mold/Tool/Plate, please contact the PCHI Asia Merchandise Team (AMT) to assist you.

**24. Advertisement:** The parties hereto agree that if Vendor has represented that it will publicly advertise the Merchandise in accordance with a proposed schedule and thereafter Vendor shall, without the prior written approval of THE COMPANY, fail to advertise Merchandise in accordance with such schedule, THE COMPANY may return such Merchandise to Vendor and may charge the Vendor with the cost of transportation, shipping, unpacking, examining, repacking, reshipping and other like expenses. Any claims for failure to advertise the Merchandise in accordance with such schedule made by THE COMPANY shall be charged back to Vendor and the amount thereof deducted from payments to be made to Vendor or, alternatively, to be promptly refunded to THE COMPANY. ANY ADVERTISING THAT WILL USE ANY PROPRIETARY RIGHTS OF THE COMPANY IS SUBJECT TO PRIOR WRITTEN APPROVAL OF THE COMPANY, AS FURTHER DESCRIBED IN THE COMPANY VENDOR STANDARDS MANUAL.

**25. Indemnification:** Vendor shall indemnify, defend and hold THE COMPANY harmless from and against any and all alleged, actual or threatened liability, claim, loss or damage arising in any way whatsoever out of or in connection with the sale, advertising, possession, handling, use, importation, manufacture, display, misuse, resale, labeling or return of the Merchandise ordered (and if the Merchandise shall include the sales of services, the provision of such services). Vendor shall defend every suit that may be brought against THE COMPANY by reason of any of the foregoing, whether meritorious or not, and shall pay all expenses and fees of counsel which shall be incurred in connection with such defense, together with all costs, damages and any other sums recoverable in every such suit or settlement thereof. If Vendor fails to take timely action to defend such a suit, THE COMPANY may defend such suit at Vendor's expense. THE COMPANY, in addition to any other rights, may forthwith cancel any unshipped portion of the Order and return prior deliveries to Vendor for payment or credit. With respect to any claims falling within the scope of the foregoing indemnifications, Vendor agrees to keep THE COMPANY fully advised with respect to such claims, the progress of any suits, and legal settlements involving same or similar products sold or distributed to THE COMPANY. Additionally, THE COMPANY shall have the right to participate, at Vendor's expense, in any suit instituted against it, and to designate attorneys to defend it. Any designated attorneys shall be independent of attorneys chosen by Vendor relating to such claim or any related claim. Vendor is not to settle, compromise or otherwise enter into any agreement regarding the disposition of any claim against THE COMPANY without the written consent and approval of THE COMPANY.



**HALLOWEEN CITY**



## Section - 2

**26. Restricted Products:** Vendor acknowledges and agrees that it shall take all steps necessary to restrict products that it purchases from THE COMPANY from being offered for sale within those jurisdictions that have enacted any law or regulation which prevent their sale (the "Restricted Products"). Vendor hereby agrees to indemnify THE COMPANY and undertake to defend and hold THE COMPANY harmless from and against any liabilities or expenses of any nature or description whatsoever arising out of its failure to prevent Restricted Products from being sold within such jurisdictions.

**27. Confidentiality:** "Confidential Information" means nonpublic information that THE COMPANY designates as being confidential or which, under the circumstances surrounding disclosure ought to be treated as confidential by Vendor. Confidential Information includes, without limitation, information in tangible or intangible form relating to and/or including released or unreleased THE COMPANY products, the marketing or promotion or any THE COMPANY product, THE COMPANY's business policies or practices, and information received from others that THE COMPANY is obligated to treat as confidential. Confidential Information shall not include any information, however designated, that i) is or subsequently becomes publicly available without Vendor's breach of any obligation owed to THE COMPANY; (ii) became known to Vendor prior to THE COMPANY's disclosure of such information to Vendor pursuant to the terms of this Agreement; (iii) became known to Vendor from a source other than THE COMPANY other than by the breach of an obligation of confidentiality owed to THE COMPANY; or (iv) is independently developed by Vendor. Vendor shall refrain from disclosing any Confidential Information to third parties. Vendor shall take reasonable security precautions, at least as great as the precautions it takes to protect its own confidential information, but no less than reasonable care, to keep confidential the Confidential Information or any other breach of this Agreement by Vendor and its employees and consultants, and will cooperate with THE COMPANY in every reasonable way to help THE COMPANY regain possession of the Confidential Information and prevent its further unauthorized use or disclosure. Vendor shall, at THE COMPANY's request, return all originals, copies, reproductions and summaries of Confidential Information and all other tangible materials and devices provided to Vendor as Confidential Information, or at THE COMPANY's option, certify destruction of same. Vendor acknowledges that monetary damages may not be a sufficient remedy for unauthorized disclosure of Confidential Information and that THE COMPANY shall be entitled, without waiving any other rights or remedies, to such injunctive or equitable relief as may be deemed proper by a court of competent jurisdiction.

**28. Liability Insurance:** Vendor shall purchase and maintain, at its sole cost and expense, Comprehensive General Liability insurance including Products Liability coverage with limits of not less than \$2,000,000 each occurrence; Combined Single Limit each occurrence Bodily Injury and Property Damage, General Aggregate **not less than** \$4,000,000 per year. Such insurance shall be carried by an insurer with an A.M. BEST rating of A VII or better. Coverage shall include Broad Form Property Damage, Contractual Liability including Defense Costs, Cross Liability exclusion deleted, Personal/Advertising liability and shall provide Waivers of Subrogation. Vendor agrees to continuously maintain such insurance for the period during which any party may, as a matter of law, be entitled to assert a claim against any Indemnified Party. To the extent Vendor shall be providing delivery or other services to THE COMPANY, Vendor shall provide evidence of automobile coverage (**not applicable for International Vendors**) as well as Worker's Compensation (**not applicable for International Vendors**) and Employer's Liability evidencing the coverage to applicable statutory limits and Employer's Liability to limits of \$1,000,000. The insurance company issuing such policy shall bear endorsements to the effect that THE COMPANY shall be notified not less than thirty (30) days in advance of modification or cancellation thereof (except that such notice shall be 10 days in advance for nonpayment of premium) by certified mail to THE COMPANY Attention: THE COMPANY Logistics/Vendor Relations.

**The policy shall also bear endorsements naming THE COMPANY and Party City as additional insureds under the Broad Form Vendors Endorsement as follows:**

**Party City Holdings, Inc. and its affiliates and subsidiaries  
80 Grasslands Road  
Elmsford, NY 10523**



**HALLOWEEN CITY**



## Section - 2

A renewal certificate evidencing the insurance coverage required pursuant to this Agreement shall be provided to THE COMPANY at least thirty (30) days prior to the expiration of the policy. **Vendor shall furnish to THE COMPANY a certificate of insurance evidencing such insurance within thirty (30) days following commencement of this Agreement.** Vendor specifically agrees that the indemnities referenced in this Agreement are not limited to the insurance coverage set forth in this paragraph. Vendor/and/or Vendor's representatives', insurers' or agents' failure to comply with the insurance of this Agreement shall be considered a breach of this Agreement.

**29. Additional Work Performed:** All work performed by Vendor and all materials used in connection with any Order shall be at the risk and expense of Vendor until delivered and accepted by THE COMPANY. If any Order calls for work to be performed by Vendor upon any premises owned or controlled by THE COMPANY, Vendor shall keep such premises and work free and clear of all liens and shall furnish THE COMPANY with any certificate, affidavit or waiver as provided by law. Whenever Vendor has in its possession any of THE COMPANY's property, Vendor shall be deemed an insurer thereof and shall be responsible for its safe return to THE COMPANY.

**30. Anti-Corruption Compliance:** Vendor agrees to comply with THE COMPANY'S Anti-Bribery Policy, as discussed in Section 1 of the VSM, and all applicable antibribery/corruption laws (including but not limited to the U.S. Foreign Corrupt Practices Act (the "FCPA"), the UK Bribery Act of 2010, the OECD Anti-Bribery Convention, and the Canada Corruption of Foreign Public Officials Act). Vendor agrees that it shall not receive, pay, offer, authorize, or promise anything of value in order to provide or obtain an improper benefit. THE COMPANY does not tolerate bribery or corruption, regardless of local customs. Vendor represents, warrants and covenants that no principal, partner, shareholder (of 5% or more of Vendor's stock), member, officer, director agent, contractor or employee of Vendor or its subsidiaries and affiliates is an official of any governmental body, agency, or state-owned entity. Vendor shall provide prompt notice in writing to THE COMPANY'S Global Compliance Office if the foregoing representation becomes inaccurate at any time. Vendor shall not, in the conduct of its performance to provide products or services to THE COMPANY, and with regard to any funds, assets, or records relating thereto, offer, pay, give, or promise to pay or give, directly or indirectly, any payment or gift of any money or thing of value to any government official (including, without limitation, any officer or employee of a government agency or government-controlled enterprise or of a public international organization, or a person acting in official capacity for or on behalf of a government or public international organization, or a candidate for political office, a political party, or party official) to improperly influence any acts or decisions of such official; If there is a reasonable basis to conclude that the Vendor has failed to comply with THE COMPANY'S Anti-Bribery Policy (including the requirements of this paragraph), THE COMPANY may terminate its relationship with Vendor immediately without notice and without liability, and the business relationship between Vendor and THE COMPANY shall, in the event of termination by THE COMPANY hereunder, be rendered void.

**31. Jurisdiction and Venue:** Vendor consents to the jurisdiction of, and agrees that any suit, action or proceeding arising out of or in any way related to the Merchandise shall be brought in the courts of the State of New York or the United States District Courts for the District of New York. Vendor waives any objection it may have to the venue or forum of any such controversy that is brought in the aforementioned courts and waives any claim that any such controversy has been brought in an inconvenient forum and consents to the jurisdiction of the aforesaid New York Courts.

**32. Taxes:** Except as otherwise provided herein, and unless prohibited by statute, Vendor shall pay any federal, state or local use tax, transportation excise tax, or other tax which may be imposed in connection with the performance of the Order.

**33. Waiver:** THE COMPANY'S failure to insist on strict performance of any term or terms hereunder shall not constitute a waiver of any term or default by Vendor. Any waiver of any breach or default hereof shall not constitute a waiver by THE COMPANY of any other or subsequent breach or default of Vendor.

**34. Resale:**

- (a) THE COMPANY acknowledges that it holds valid resale numbers in all states where THE COMPANY is licensed to do business (excluding states not recognizing sales for resale as sales tax exempt).



**HALLOWEEN CITY**

## Section - 2

- (b) Vendor shall furnish THE COMPANY (attention to: THE COMPANY's Tax Department), when required by law, with the appropriate exemption certificate which shall be completed by THE COMPANY and returned to Vendor. THE COMPANY's "Blanket Resale Certificate" may be substituted by THE COMPANY, if permitted by law.

**35. Information Security:** Vendor agrees to immediately notify THE COMPANY of any (i) improper or unauthorized use of (ii) reasonable concern about the security of THE COMPANY's confidential information (including any personal data pertaining to THE COMPANY's customers) in the possession of the Vendor (a "Data Incident"). Notification shall be made to both the Vendor's principal point of contact at THE COMPANY and in writing to [compliance@partycity.com](mailto:compliance@partycity.com). The Vendor shall cooperate in any investigation of the Data Incident undertaken by THE COMPANY.

**36. Miscellaneous:** Vendor agrees that it will not offer employment to, employ, hire or otherwise engage the services of any person who is or has been, within the preceding 180 days, an employee of THE COMPANY.

Vendors must limit communication to stores, store specific/franchisee specific issues only. All general communication must be made through THE COMPANY Corporate office.

Vendor shall not offer or provide to any THE COMPANY Associate any gifts, gift certificates, discounts, gratuities, services or any other item of value. Any deviation from this policy could result in the termination of Vendor's relationship with THE COMPANY. All exceptions must receive prior written approval by THE COMPANY's CEO or CFO.

**37. Reporting Misconduct:** To report issues regarding accounting, internal accounting controls or other business conduct matters, including misconduct by employees of THE COMPANY, please contact: [compliance@partycity.com](mailto:compliance@partycity.com).

**Section – 3a,c (Retail)****Merchandise Information****Overview – Party City (includes Party City, Party America, and Halloween City)**

This section outlines the general guidelines for Purchase Order (PO) requirements, product requirements, and UPC usage requirements.

All forms referenced in this section can be found in the Appendix. The New Item Form is available on the internet at [www.partycityvendors.com](http://www.partycityvendors.com).

**Changes to Product Information**

Any changes (i.e. to the pricing, product, discontinuation, UPCs, item#, case packs, inner packs, product dimensions, shipping case dimensions, or packaging) must be stated in writing or e-mail and presented to the appropriate Category Manager for approval. Notification of everyday item changes must occur 60 days prior to the effective date. Notification of seasonal item changes must occur 60 days prior to the expected order placement date.

**PO Requirements**

Our goal is to offer merchandise that presents value and is consistently in stock at a price to satisfy our customers. Vendor must verify the accuracy of, and adhere to, all data on all POs, Corporate and Franchise.

If you have questions regarding a Corporate PO, contact the following department for each specific instance:

**PO Contacts**

- Planning and Allocation Manager -- Every Day/Replenishment orders - quantities or in-store dates
- Category Manager -- All Seasonal orders- quantities or in-store dates; All item specific issues including incorrect costs, UPC's, case pack, vendor item numbers, etc...
- New store orders -- Email [ckalman@partycity.com](mailto:ckalman@partycity.com)
- Franchise stores -- All franchise PO questions regarding quantities or dates - (Item specific issues, contact Category Manager)

Vendors must utilize the "**Ship To Bill To (S2B2)**" file to determine if an order is for a corporate or franchise store. If you are not receiving periodic updates via email broadcast, email Caryl Kalman at [ckalman@partycity.com](mailto:ckalman@partycity.com) to be added to the distribution list.

**Purchase Order Confirmation (Corporate and Franchise):**

**Vendors must be capable of receiving Party City POs via Electronic Data Interchange (EDI) transmittals.** All vendors must be able to process EDI documents. For more information on EDI, reference Section 4.

**Section – 3a,c (Retail)**

In order to achieve our goal of having the right merchandise at the right time, we must ensure our vendors ship the exact merchandise and quantities ordered on a PO. Listed in this section are ways we can achieve our goal:

- Vendor must be in receipt of a valid PO prior to shipping any product. The PO number must not be modified in any way.
- Party City PO number is unique for each order and should not be in vendor system more than once. Vendor's system must prevent duplicate PO's in their system. Duplicate PO's will be subject to reimbursement as listed in the Reimbursement and Waiver Policy, Section 10. All rewrites will generate a new PO number.
- When shipping, each carton must contain contents for one PO number only.
- Each invoice must include only one PO number; however, a single PO can have multiple invoices.
- **If any item specific information is not correct upon receipt of PO, including item#, case pack, UPC or cost you must contact the Category Manager immediately. Vendor must invoice with the PO cost and Party City will pay the lowest cost between the PO and the invoice. POs with case pack or cost errors must be cancelled and rewritten.**
- Terms and Conditions, contained in Section 2, apply to all POs. The terms and conditions may be supplemented or amended by specific terms and conditions incorporated on a specific PO.
- Vendor must be aware of expected in-store delivery dates, pre-paid or collect, ship to bill to, or other conditions which may vary based on the source of the PO (corporate or franchise). Vendor must execute the terms and conditions (including the ship to location on the PO) on each individual PO.

**Changes to PO Information**

Changes to a PO can include changes to line item quantity, delivery date, etc. These changes will be reflected through a cancelled PO and issuance of a new PO. If you are unable to fill an everyday PO, contact the Planning & Allocation (P&A) Manager via e-mail for a cancellation or extension, seven days prior to the first ship date for approval. Requested changes to seasonal POs must be communicated in writing to the Category Manager within seven calendar days of the PO request. Verbal agreements are not acceptable. In-store deliveries received after the Vendor Cancellation Date will be subject to penalties as listed in the Reimbursement and Waiver Policy, Section 10.

An authorized Party City representative will submit all Party City initiated PO changes, including cancellations, to the vendor in writing via e-mail. Party City does not send the 860 – PO cancel/change document. Associates in the Merchandising Department and Planning and Allocation Department are authorized to make changes to POs. PO changes include PO cancellation requests. If a line item(s) needs to be changed, the PO will be cancelled, and a new PO will be generated.

Party City will not accept shipment of substitute items unless pre-approved in writing by a Category Manager AND followed by a new PO for the substituted items. Substitute items will be subject to penalties as listed in the Reimbursement and Waiver Policy, Section 10.

**UPC Codes**

All vendors are required to join GS1 US, formerly known as the Uniform Code Council (UCC), in order for products to be UPC source marked. A scannable UPC must be securely attached or clearly printed on every item or item package. All Halloween costumes must be UPC coded by size (and color where appropriate) for all orders.





## Section – 3a,c (Retail)

Party City recommends you never reuse UPC codes. If unavoidable, you must wait a minimum of 48 months before re-use and notify Party City.

### Item UPC Label Guidelines

The correct printing of clear UPC's is of primary importance due to market sensitivity. If an incorrect UPC is printed or the UPC is un-scannable, there will be no initial warning due to the ramifications of the error and chargebacks will be issued as listed in the Reimbursement and Waiver Policy, Section 10.

All barcodes appearing on the label printed for Party City's use shall meet the specifications contained herein.

- White labels are to be used unless specifically directed otherwise
- Print in black
- All UPC's should be in standard UPC-A format and scan at the grade level of "C" or better
- Barcode must be scannable
- Label size needs to be an appropriate size for the item
- One label is to be used unless the item/each come in a box, container, or display. In this case the box, container, or display AND the piece must each have the label.
- Small items that cannot fit a full label should have a butterfly label (same label as used for jewelry items) or hang tag.
- Placement of UPC label should not interfere with operating or product care instructions, as well as any other pertinent product information

### Product Samples

Product samples must be sent within 72 hours of a Category Manager's request. **All samples must be clearly marked with the vendor item number, recipient's name, and/or description.** All samples are to be shipped prepaid (regardless of VPA freight terms) to the attention of the requesting Category Manager at Party City or Halloween City using one of the below addresses:

**Party City Corporation  
25 Green Pond Road, Suite 1  
Rockaway, NJ 07866**

**Halloween City  
35901 Veronica  
Livonia, MI 48150**

Party City & Halloween City will not pay for samples, shipping charges, import charges, or return samples (select sample returns can be done on a limited basis with the written pre-approval from a Category Manager and call tags or package return label). Product samples, if late, may be subject to penalties as listed in the Reimbursement and Waiver Policy, Section 10. In addition, incorrect Plan-O-Gram (POG) dimensions may be subject to penalties as listed in the Reimbursement and Waiver Policy, Section 10.

## Section – 3a,c (Retail)

### New Store Merchandise Requirements

Party City continually plans to open new stores. Vendor partner support in opening new stores is critical to our success.

### New Store Orders

- Shipping a new store PO indicates the vendor’s agreement to the requirements and terms as outlined in the VSM.
- Our goal for all new store POs is a fill rate of 100%. Purchase orders are generally written far enough in advance to accomplish complete fill.
- If the initial order has a fill rate below 100%, the new store will accept one back order before canceling the PO. Back order must arrive before the end of the arrival window. Fill rate measurements will be calculated on combined shipments tendered during the arrival pick up window.
- Some orders may require small quantities of certain items to be shipped loose in larger boxes. When this happens vendor should ship all like items for a PO in the same box, packed together, to the degree possible. This minimizes damages and improves receiving accuracy at our stores.
- Orders not meeting our fill rate requirements will be subject to penalties as listed in the Reimbursement and Waiver Policy, Section 10.
- New store orders (identified by “NS” as the Dept/buyer code) must NOT deliver earlier than the 1<sup>st</sup> Delivery Date. This includes orders for new stores, relocations and conversions. Early freight attempted to deliver prior to 1<sup>st</sup> Delivery date is subjected to delivery refusal with freight returned to vendor or receipt by a non-PC employee and unpaid invoices.

### Corporate Everyday and Replenishment/Re-Order

**POs will contain the following dates. No back orders are allowed on Everyday and Replenishment/Re-Order POs.**

Everyday and Replenishment PO Dates (Party City Only)			
Data Field on Party City Faxed/PDF PO	Definition	Data Fields on EDI 850 PO	850 Code
PO Date	Date PO created by Party City	PO Date	
1st Delivery Date	The date specified by Party City of when the merchandise is expected to be delivered to the Party City location.	Do not deliver before date	064
Vendor Cancel Date	The date specified by Party City when PO will be cancelled if merchandise is not delivered to store by	Cancel if not delivered by	061

- The first date in the arrival window is equivalent to the “**1st In-Store Delivery Date**”. The second date in the arrival window is equivalent to the “**Vendor Cancel if not Delivered by Date**”. It is the vendor’s responsibility to ship or tender orders in a timely manner to ensure product arrives within the window. Orders received after the In-Store Date will be subject to chargeback. For delivery reimbursement charges, refer to Reimbursement and Waiver Policy, Section 10.

**Section – 3a,c (Retail)**

- Shipments must be consolidated so deliveries to the same location do not ship on consecutive days of a week. Orders not meeting our minimum fill rate or not consolidated will be subject to penalties as listed in the Reimbursement and Waiver Policy, Section 10.
- Vendor must ship replenishment orders within 72 hours of receipt to arrive at the store within the requested delivery window.
- All unshipped individual sku line item order quantities will be “cancelled” off the PO upon receipt of the invoice. This will allow us to reorder unshipped quantities within the next PO cycle. Note: 860 EDI documents will not be sent for this transaction. Do not send more than one invoice per PO over multiple days. If you ship from more than one warehouse, resulting in more than one invoice, you must notify the P&A Manager prior to sending the invoice.

**Seasonal and New Store Orders**

**POs will contain the following dates. Party City will accept back order shipments on Seasonal POs with Merchant approval. New Store POs we will accept one back order shipment only.**

<b>Seasonal and New Store Corporate PO Dates (Party City Only)</b>			
<b>Data Field on Party City Faxed/PDF PO</b>	<b>Definition</b>	<b>Data Fields on EDI 850 PO</b>	<b>850 Code</b>
PO Date	Date PO created by Party City	PO Date	
1st Delivery Date	The date specified by Party City of when the merchandise is expected to be delivered to the Party City location.	Do not deliver before date	064
Vendor Cancel Date	The date specified by Party City when PO will be cancelled if merchandise is not delivered to store by	Cancel if not delivered by	061

- All Seasonal shipments must conform to the specified Party City Seasonal-receiving window, unless otherwise noted on the PO. Franchise POs may frequently request a date different than a corporate arrival window. However, if **“ASAP”** or if no date is provided on a franchise PO, use the corporate receiving window. Shipments arriving outside of the window are subject to a reimbursement charge. If you are going to miss the receiving window you must contact your Party City Category Manager or P&A Manager.
- Every new store will have an arrival window for receiving merchandise. The first date in the arrival window is equivalent to the **“1st In-Store Delivery Date”**. The second date in the arrival window is equivalent to the **“Vendor Cancel if not Delivered by Date”**. The arrival window will begin approximately 3 to 4 weeks prior to a new store opening to the public. It is the vendor’s responsibility to ship or tender orders in a timely manner to ensure product arrives within the window. Orders received after the In-Store Date (arrival window) will be subject to charge-backs. For delivery reimbursement charges, refer to Reimbursement and Waiver Policy, Section 10.
- Shipments must be consolidated so deliveries to the same location do not ship on consecutive days of a week. Orders not meeting our minimum fill rate will be subject to penalties as listed in the Reimbursement and Waiver Policy, Section 10.
- Vendor must ship in-season replenishment orders within 72 hours of receipt to arrive at the store within the requested in-store delivery window.
- Stores will not accept cash on delivery (COD) shipments unless prior written arrangements are made.
- Stores, including franchise, are not liable to receive or pay for any merchandise tendered past the arrival window dates.

**Section – 3a,c (Retail)**

- For the purposes of calculating vendor minimums, the total cost (or weight) of all POs destined for a single location will be used. For example, the total combined weight or cost of multiple orders with the same ship date will be considered as meeting the vendor minimum as a group, each individual PO will not need to meet minimums.
- In the event the quantity ordered does not match the quantity shipped on a PO, the quantity ordered on a PO will be used to calculate the vendor minimum (backorders will not be required to meet min).

**Halloween City Orders**

- All Halloween City shipments must conform to the specified arrival date as noted on the PO. If you are going to miss the arrival date, you must contact the Planning & Allocation (P&A) Manager. Shipments arriving after the arrival date are subject to a reimbursement charge.
- Orders not meeting our minimum fill rate will be subject to penalties as listed in the Reimbursement and Waiver Policy, Section 10. In the event the quantity ordered does not match the quantity shipped on a PO, the quantity ordered on a PO will be used to calculate the vendor minimum.
- Halloween City Stores and Distribution Centers will not accept cash on delivery (COD) shipments.

**Refer to Reimbursement and Waiver Policy, Section 10, of the VSM for a full listing of reimbursement charges.**



## Section – 3b (Wholesale)

### Merchandise Information

#### Overview

This section outlines the general guidelines for Party City Holdings, Inc. (PCHI) wholesale consisting of Amscan and Anagram International unless stated otherwise. The guidelines included in this section are Purchase Order (PO) requirements, UPC usage requirements, and new product quoting and approval process.

#### PO Requirements

Vendor must verify the accuracy of, and adhere to, all data on all POs that are **communicated through email or** sent electronically. If you have any questions regarding your PO, contact the **corresponding** division's Inventory Department **Manager or email [inventoryplanning@partycity.com](mailto:inventoryplanning@partycity.com)**.

#### Purchase Order Confirmation/**Acknowledgement**

**PCHI** Inventory Department sends a number of POs (both everyday and seasonal) to our vendors. An email acknowledging receipt of all PO's **by the Vendor** must be sent within 48 hours to the **corresponding** division's Inventory Department **Manager with a C.C. to [inventoryplanning@partycity.com](mailto:inventoryplanning@partycity.com)**. **Three times a week a UNACK report will be run showing what vendors have not confirmed their PO's and the Vendors will be contacted accordingly.**

The confirmation must include **the** following **details**:

- PO #
- Item #
- Quantity
- Cost
- **Cargo Ready Date**

#### Purchase Order Shipments

- Vendor must be in receipt of a valid PCHI PO, including a PO number, prior to shipping any product. The PO number must not be modified in any way.
- Terms and Conditions, contained in Section 2, apply to all POs. The terms and conditions may be supplemented or amended by specific terms and conditions incorporated on a specific PO.
- Vendor must be aware of expected ship dates and specific shipping contract instructions (per the Transportation Routing Guide – Section 8). Vendor must execute against the terms and conditions (including the ship to location on the PO) on each individual PO.



## Section – 3b (Wholesale)

### Changes to Vendor Information

Documentation must be e-mailed or faxed and signed by a senior officer of your company. All changes must be received 14 days prior to their effective date. Changes would include, but are not limited to:

- Change in remittance address
- Change in company name
- Change in company ownership: If a change in ownership occurs and the new owner is not currently in our vendor file as an authorized vendor, the company will be considered a new vendor and will be required to complete a New Vendor Package - NVP.
- Change in legal structure
- Bankruptcy Filings
- Change in "Return to Vendor" address
- Change in Shipping address
- **Change in Banking**

The letter communicating changes must contain the following information:

- Your company name and Amscan vendor number
- Statement of the change being communicated
- Signature of a senior vendor officer or agent

### Written notification of changes must be emailed to the following:

Amscan Inc: [vendorrelations@amscan.com](mailto:vendorrelations@amscan.com)

Anagram International: [vendorrelations@anagramintl.com](mailto:vendorrelations@anagramintl.com)

Do not send any vendor updates or changes to the Product Managers as they cannot approve or process any vendor changes.

PCHI reserves the right to hold payments pending receipt of this documentation.

### Changes to Product Information

Any changes (i.e. to the pricing, product, UPCs, case packs, inner packs, product dimensions, shipping case dimensions, or packaging) must be emailed to the appropriate **TOPS Manager** for approval. A copy of the product packaging changes must be emailed to the appropriate wholesale entity below:

Amscan Inc: [TOPS@amscan.com](mailto:TOPS@amscan.com)

Anagram International: **Valerie Luebke**, [luebkev@anagramintl.com](mailto:luebkev@anagramintl.com)

Vendor may be held responsible for additional handling and shipping fees for any changes made on or after the ship date.

### Changes to PO Information

Any changes to the Purchase Order ship date needs the approval of the Inventory Manager who issued the Purchase Order. **The updated PO will be issued within 2 business days.**



## Section – 3b (Wholesale)

### Purchase Order Cancellation

PCHI reserves the right to cancel a Purchase Order or request expedited shipping **at the Vendor's expense** if the PO "Must Ship by" date is not met.

### UPC Usage Requirements

Accurate item information is critical for PCHI to service our customers and effectively manage inventory. A scannable UPC must be securely attached or clearly printed on every item or item package, inner pack and master carton.

### New Product Quoting Process

Vendors are required to submit all new product quotes to the PCHI Product Development team on the appropriate standard Product Quote form. (see Appendix for Product Quote form for Amscan)

### Product Development, Product/Package Approval Process

#### Sample Approval Process: PCHI Party Products ("Party")

##### Purpose

Provides overview of PCHI's sample approval process for both international and domestic suppliers of Party Products and how it relates to prototype approval and quality validation. We strive to consistently receive pre-production samples from all vendors. The expectation is to review all approval, pre-production, and production samples and for the factory to keep their signed and dated sample at each stage for reference. If a factory change is made at any point in the product lifecycle, the keepsake sample should move to the new factory, and PCHI PD&D (Product Design & Development) should receive a sample from the new factory to ensure it matches expectations. **PD&D may be in Asia (as part of AMT) or in the PCHI USA office and the Product Manager will specify to which PCHI office that approval samples shall be sent.** If approvals are done by AMT, AMT keeps the sample from the new factory for their records. If approvals are done by USA office, Product manager arranges for sample retention from the new factory.

##### Benefits

- Ensures PCHI and Vendors have clear quality and aesthetic expectations for production.
- Ensures products in the store are the quality and design that was intended.

##### Procedure

Vendor produces samples and/or components, typically within four weeks of receiving artwork and specifications, that reflect all desired product details, encompassed in the product and/or packaging specification, identified functionality and correct mold, and submits to PD&D for approval. Vendor shall inform PD&D if sample creation is longer than four weeks.

- Samples can be created in a sample room or in the factory of production. However, factory sampling is preferred to identify any key issues with execution in mass production.
- All samples/components submitted for approval must have the appropriate sample tag attached (sample tag below). These sample tag templates will be sent to all vendors to tag each version. The tag colors break down as follows:



## Section – 3b (Wholesale)

- White = Quality/Material Reference Sample (Approval Sample)
- Yellow = Pre-Production (PP) Sample
- Green = Production Sample

After receipt of the sample, PD&D accepts the following as confirmation of a prototype approval for samples and/or components. PD&D works with cross functional team members to review and proof the sample based on the following guidelines:

- Prototype approvals are indicated by white tag.
- Product Manager decides and indicates in PLM by whom, AMT or US-based Product Manager, Pre-production samples are approved.

General guidelines are that AMT would review and approve non-wearable product formats which use paper as the primary material and are produced with well-established and approved vendors and factories, subject to Product Manager direction in PLM.

There are 3 options to proofing comments for sample approval:

- 1) Approved:** product/package is approved as is and the vendor can proceed with production.
- 2) Approved with Changes:** the vendor must make the requested changes detailed in the proof sheet and may then proceed with production without the first sending a new sample for approval. This is only when time is of the essence and another round of samples/proof sheets will slow production and jeopardize the delivery window or when the changes are relatively minor. Vendor shall provide production samples to PD&D for confirmation that the requested changes were made. If the production samples are approved by PD&D, these become the signed and dated inspection reference samples.
- 3) Rejected/Requires changes:** the vendor must make the requested changes details in the proof sheet and submit another sample for approval. The product/package is not yet approved for production.

Proof comments are emailed directly to the vendors as vendors do not have access to PLM. PD&D attaches the appropriate label tag, signs and dates it, applies "chop" or signature as needed, and sends it back to the vendor for their records. Vendor will use the approved sample to make sure the production samples match the final approved sample that was signed by PD&D and factory will use approved sample as the official signed and dated inspection reference sample for QC inspection. Reference sample degradation is possible in the factory environment, so approved reference samples should be updated annually or whenever there is a significant change in factory, manufacturing process(es), design, material(s), or construction.



## Section – 3b (Wholesale)

### Sample Approval Flow Chart

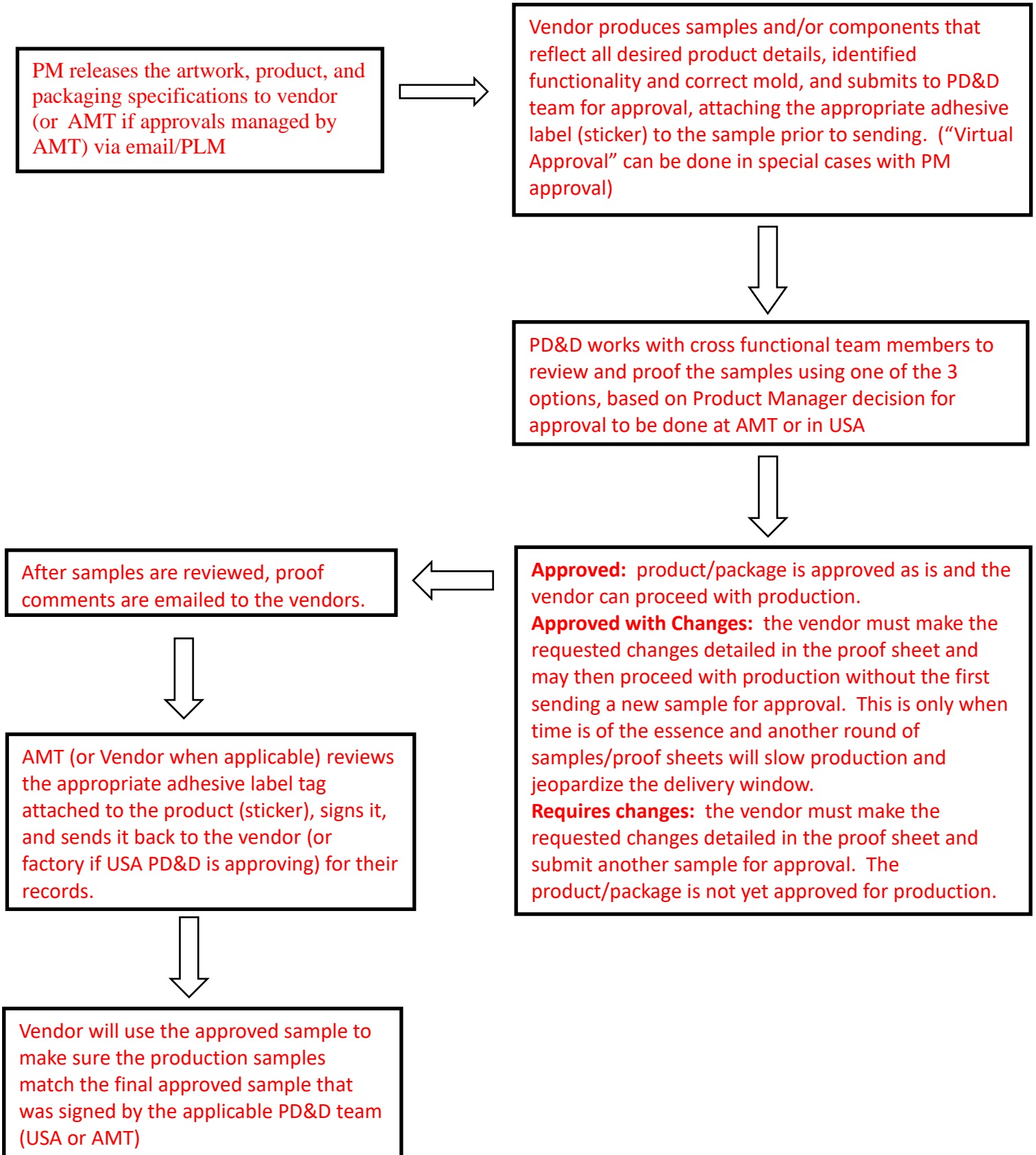

### Section – 3b (Wholesale)

#### Quality/Material Reference Sample Tag

#### PP Sample Tag

#### Production Sample Tag



### Sample Approval Process: Costumes & Wearable Accessories (“Wearables”)

#### Purpose

Provides overview of the product sample approval process for both international and domestic suppliers and how it relates to prototype approval and quality validation. We strive to consistently receive Pre-Production samples in a timely manner from all vendors. The expectation is to review approval, pre-production, and production samples and for the factory to keep their signed and dated sample(s) at each stage for reference. If a factory change is made at any point in the product lifecycle, the keepsake sample should move to the new factory, and PD&D (Product Design & Development) team should receive a sample from the new factory to ensure it matches. **PD&D may be in Asia (as part of AMT) or in the PCHI USA office and the Product Manager will specify to which PCHI office that approval samples shall be sent.** The PD&D team would then keep the sample from the new factory for their records. If there is a significant change in material, design, construction or manufacturing process(es), PD&D team should receive a new sample to ensure it matches design specifications. The PD&D team and factory would keep the new sample for their records.

#### Benefits

- Ensures PCHI and Vendors have clear quality and aesthetic expectations for production.
- Ensures products in the store are the quality and design that were intended.

#### Procedure

Vendor produces samples and/or components, typically within four weeks of receiving artwork and specifications, that reflect all desired product details encompassed in the product specification, identified functionality and correct mold, and submits to PD&D for approval. Samples can be created in a sample room or in the factory of production. However, factory sampling is preferred to identify any key issues with execution in mass production. Vendor shall inform PD&D if sample creation is longer than four weeks.

- All samples/components submitted for approval must have the appropriate sample tag attached (sample tag below). These sample tags MUST identify if a sample is made in a factory or sample room. If made in sample room, mark sample tag with “SR”. If factory, mark sample tag with “FTY”. These sample tag templates will be sent to all vendors to tag each version. The tag colors break down as follows:
  - White = Approval Sample
  - Yellow = PP (Pre-Production) Sample
  - Green = Production Sample



### Section – 3b (Wholesale)

After receipt of the sample, PD&D accepts the following as confirmation of a prototype approval for samples and/or components and works with cross functional team members to review and proof the sample based on the following guidelines:

- Initial approval samples are indicated by white tag
- Product Manager indicates approval and any comments via email to AMT team or vendor, as applicable

Generally, Wearables Product Managers (PM) will manage their respective new item sample approvals. Exceptions may be made for carryover styles where there are no major quality updates, factory changes or significant changes in material, design, construction or manufacturing process(es), where AMT would then manage sample approvals. If AMT approves an item, AMT would send a set of samples with approval comment(s) attached to the PM for production and shipment QC/QA verification, but PM would not make any further comment(s) prior to production as AMT has released comment(s) to vendors.

There are 3 options to proofing comments for sample approval:

- 1) Approved:** Product is approved “as is” and the vendor can proceed with the next step(s) in the process. In “approval to PP” stage, this would mean vendor is good to move forward with PP sample as is. In “PP approved” stage, this would mean vendor is good to move forward with production.
- 2) Approved with Changes:** The vendor must make the requested changes detailed via email or revised specification. Vendor shall provide production samples to PD&D team for confirmation that the requested changes were made. If the production samples are approved by PD&D team, these become the signed and dated inspection reference samples. We should never go to production without PD approval on a revised sample.
- 3) Rejected/Requires changes:** The vendor must make the requested changes detailed submitted via email or revised specification and submit another sample for approval. The product is not yet approved to move into the next phase in process or for production.

Sample comments are emailed to the vendors as vendors do not currently have access to PLM. PD&D attaches the appropriate label tag to the sample, signs and dates it, applies “chop” or signature as needed, and sends it back to the vendor for their records. Vendor shall use the approved sample to make sure the production samples match the final approved sample that was signed off by PD&D and the factory will use the approved sample as the official signed and dated inspection reference sample for QC inspection. Reference sample degradation is possible in the factory environment, so approved reference samples should be updated annually or whenever there is a significant change in factory, manufacturing process(es), design, material(s), or construction.

#### Sample Guidance: Quantities Needed for Wearables Team

Wearables Sample Direction	Carryover	Carryover w/Changes	New
<b>Approval Sample</b>	N/A	1 pc per round, golden sample size	1 pc per round, golden sample size
<b>PP Sample</b>	N/A	Full size set	Full size set
<b>Shipment Sample</b>	N/A	Full inner *If 1 piece inner, 2 inners	Full inner *If 1 piece inner, 2 inners
<b>Marketing Sample</b>	As requested	As requested	1 pc per size
<b>Advertisement Sample</b>	As requested	As requested	Use marketing sample or request additional

**Section – 3b (Wholesale)**

**Sample Approval Flow Chart**

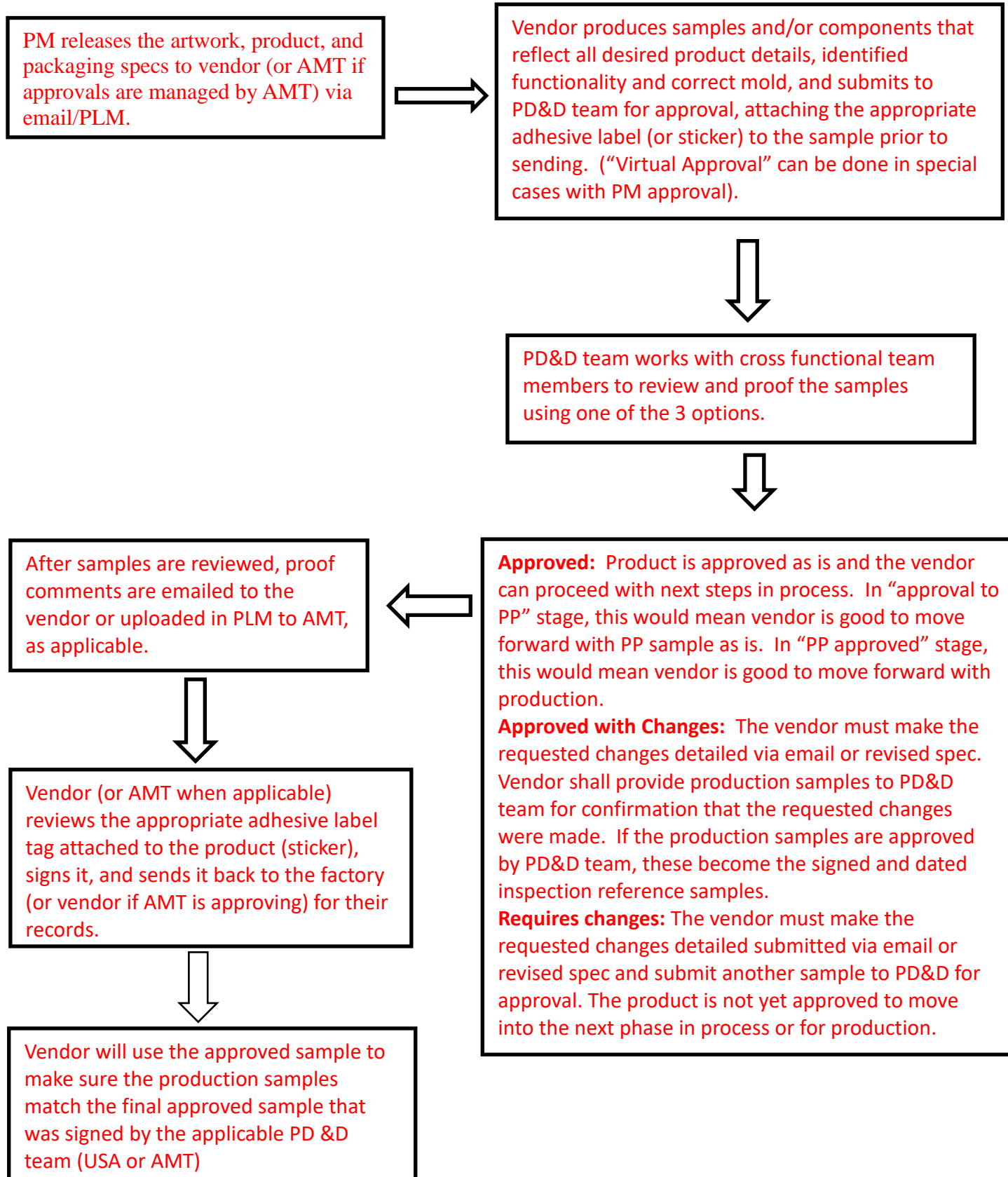

**Section – 3b (Wholesale)**

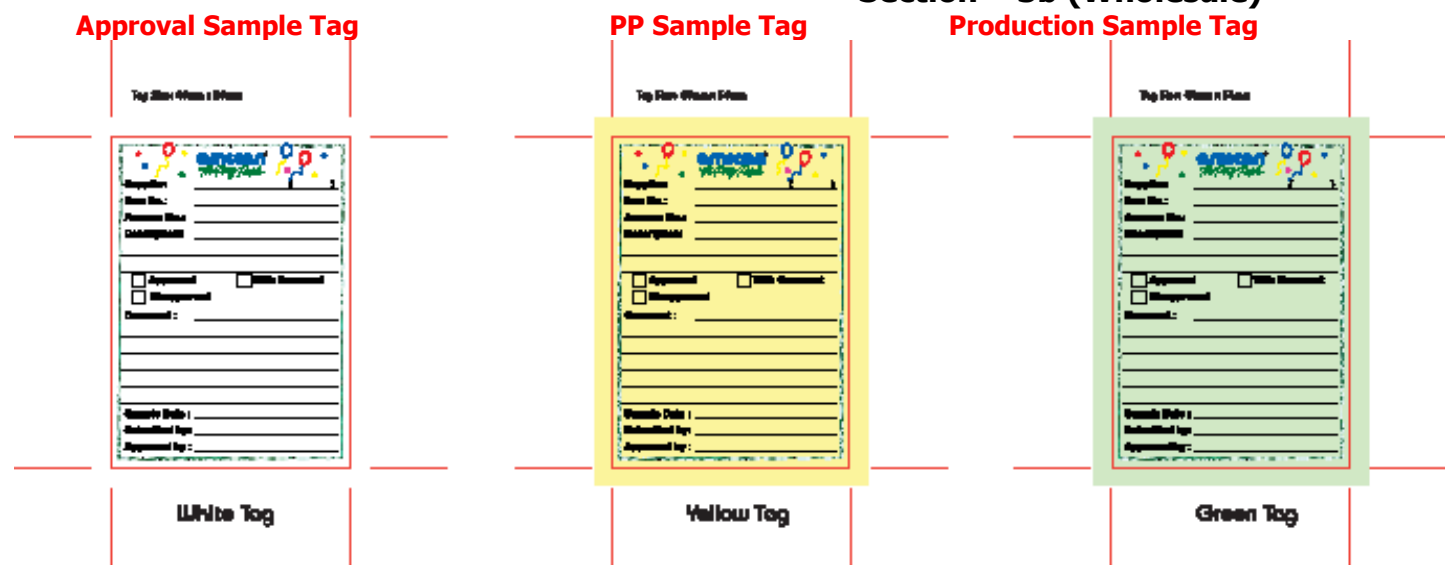

**Anagram International Product Development Approval Process**

In an effort to better facilitate the development and sourcing process a coloring system to guide the vendors through the development/sourcing at different stages has been established. Vendors are required to follow these requirements when making a submission. Unacceptable or inappropriate labeling, quantity, or samples will be rejected, and resubmission will be required.

**White Tag**

At this stage vendors are required to submit preliminary samples close to our design concepts or formats. Samples may be submitted in substitute color, material, size or even construction. All samples must have a white manila tag or with a white label attached with an accompanying quote. The quote must be sent on the Anagram International standard template where vendors are required to fill in the necessary columns. Samples processed through the Hong Kong office will have the samples and costs sent to product managers for screening and selection by Amscan. Samples not processed through the Hong Kong office are to go directly to the appropriate product manager in the United States.

In some cases where there is a potential safety hazard, vendor may be requested to submit existing testing report for review. Items including cosmetic or firework power composition require a Material Safety Data Sheet (MSDS) be sent for review prior to sending samples for selection.

**Yellow Tag**

At this stage product managers will confirm sample and cost with final vendor selection. Artwork will be sent directly to vendors via the FTP site or by [artwork link](#), dependent on vendor's request. Upon receipt of the artwork, vendors are to confirm final quote based on the artwork specifications. Vendor must immediately communicate and explain any cost variations. Vendors must follow the mechanical art for both product and package in order to proceed with creation of samples for final approval. It is expected all vendors will submit samples no more than 2 weeks upon receipt of the artwork. Vendors are to label the samples with yellow manila tag or yellow label.

If the Hong Kong office is involved with the development of an item, they will help review the yellow tag samples and confirm the sample matches item specification prior to sending samples to product managers for final approval. Rejected samples will require the vendor to re-submit the sample.



### Section – 3b (Wholesale)

When yellow tag samples are approved by product managers in the U.S. office, an approval/comment sheet will be sent to vendors via email. This document will specify one of the three statuses for the product or package:

- **Approved** – product/package is approved as is and the vendor can proceed with production.
- **Approved With Changes** – the vendor must make the requested changes detailed in the proof sheet and may then proceed with production without first sending a new sample for approval. This is only when time is of the essence and another round of samples/proof sheets will slow production and jeopardize the delivery window.
- **Requires Changes** – the vendor must make the requested changes detailed in the proof sheet and submit another sample for approval. **The product/package is not yet approved for production.**

When **AMT** initiates the development of an item, they will sign and send back to the vendor one piece of an approved sample for vendor to follow for production and inspection reference.

When the U.S. office initiates the development of an item, they will sign and send back to the vendor one piece of an approved sample for vendor to follow for production and inspection reference.

#### Green Tag

At this stage, vendors are to go into production and are also required to take one full case from the production line for review and send to:

PCHI Asia International Ltd:  
The HK AMT Office  
35/F Saxon Tower  
7 Cheung Shun Street  
Lai Chi Kok, Kowloon, Hong Kong

Anagram International:  
7700 Anagram Drive  
Eden Prairie, MN 55344

Vendor is to label the samples with green manila tags or green labels for submission. The green tag samples will be compared against the approved yellow tag samples and checked for any variance that may occur during production stage. For production samples with a variance falling within an acceptable limit, the Hong Kong office will sign and return one unit of a green tag sample to vendors as an inspection reference. If the variance falls beyond the acceptable limit, the U.S. office will provide final determination and advise of the results back to vendors. No initial shipment of an item is allowed without the green tag approval.

During the same time period samples will be requested for Plan O Grams and testing. The Plan O Gram requests are 12 pieces for bulk and 3 sets for packaged items. For testing, the requirement is six pieces; refer to the Quality Assurance section for more information. These samples do not need to be Yellow Tagged but need to be marked for its intended purpose upon sending.

Our goal is to finalize the testing for applicable SKU's with a pass result prior to shipment. Testing samples are to be drawn from production. Vendor is obliged to make sure the product meets all applicable state, county, province and federal safety and regulatory requirements for Canada and US. No shipment, for applicable SKU's, is allowed without a pass testing report from a CSPC-approved testing facility for the tests that are required. (Refer to section 6 Product Safety & Quality Assurance.) The only



### Section – 3b (Wholesale)

exception to this is for items that are part of a group testing program as advised by PCHI due to products being manufactured with the same materials, factory, process, design and construction as the tested sample(s).

#### Sample Approval Process Flowchart for International Vendors with AMT Managed Approvals

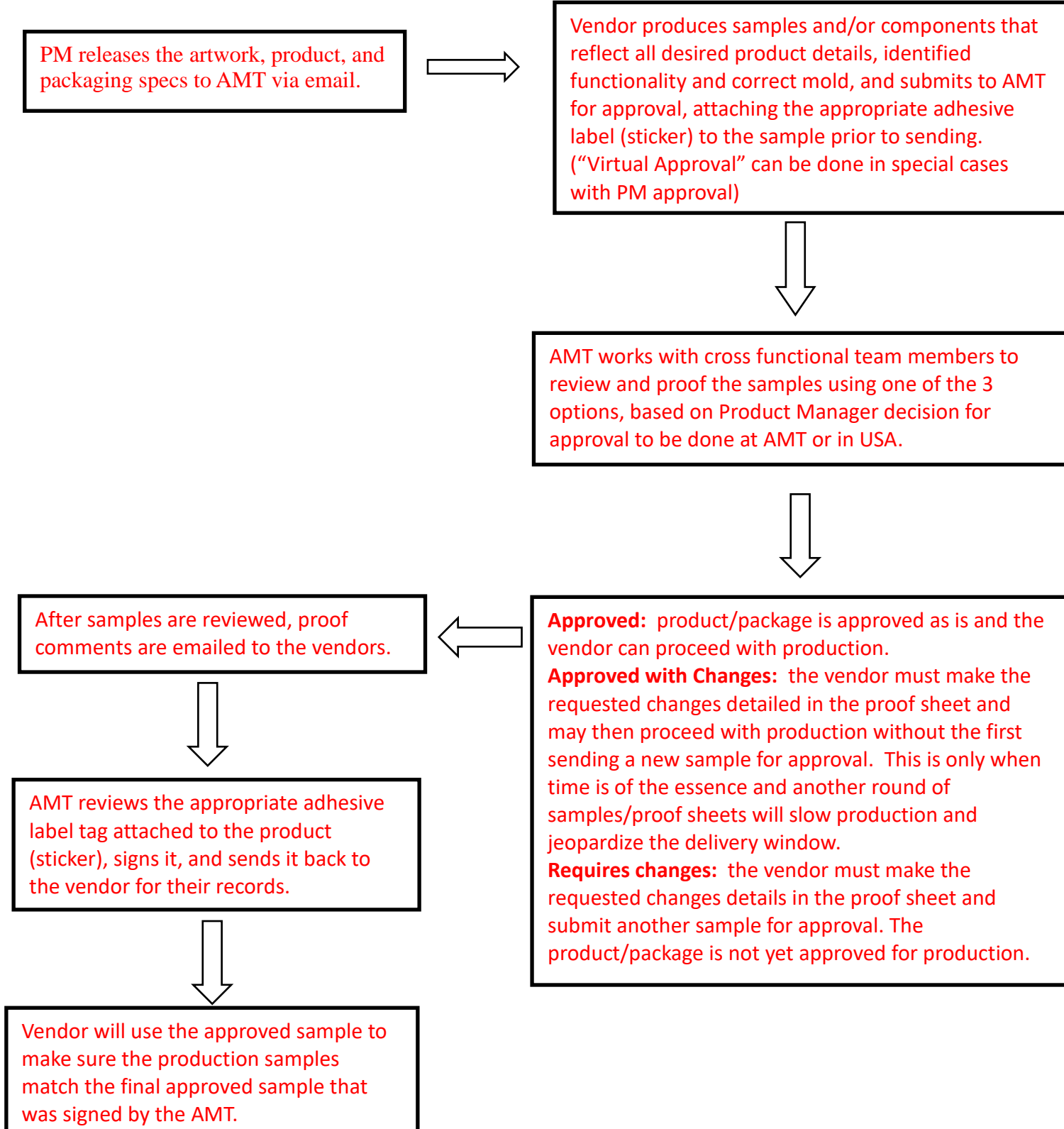

## Section – 3b (Wholesale)

### Quality/Material Ref Sample Tag

Tag Size: 4 1/2" x 8 1/2" x 1 1/2"

**White Tag**

### PP Sample Tag

Tag Size: 4 1/2" x 8 1/2" x 1 1/2"

**Yellow Tag**

### Production Sample Tag

Tag Size: 4 1/2" x 8 1/2" x 1 1/2"

**Green Tag**

### Inner Sample

Inner sample for the initial shipment of an item, two to three full inners (minimum 6 to 9 pcs) depending on the item / packaging, must be sent to the U.S. office to the attention of the appropriate product manager, at the time of production.

### HK/Foreign Samples:

HK Team receives 2-3 full production inners from the Vendors.

EOQ (qty/inner)	#Inner Boxes Sent Amscan Elmsford
1-2	5
3-5	3
6-8	2
9 and higher	2

### Domestically Handled Vendor Samples:

Vendors send production inner(s) directly to Amscan Elmsford Office to the appropriate PM.

The PD Team will distribute samples as follows:

EOQ (qty/inner)	#Inner Boxes Sent Amscan Elmsford
1-5	3
6-8	2
9 and higher	2

### Sample Costs

PCHI will not pay for samples or any shipping charges.

### PCHI Mold/Tool/Plate Library

As part of the PCHI Product Development process, PCHI aligns with its suppliers to develop Mold/Tool/Plates for our products. All Artwork, Proprietary Rights and Confidential Information which are supplied by PCHI or which are distinctive of PCHI's private label or licensed label merchandise or which contain any Proprietary Rights shall be deemed the property of PCHI. We ask that Vendors follow these steps in their oversight of these mold/tool/plates:





## Section – 3b (Wholesale)

- Maintain a library of all PCHI Mold/Tool/Plates product both active and inactive.
- Provide a quarterly on hand list of Mold/Tool/Plates to the Product Directors with a C.C. to the PCHI Asia Merchandise Team (AMT).
- Bear responsibility for the maintenance and storage of all active Mold/Tool/Plates.
- Contact the appropriate Product Director at PCHI prior to disposing or destruction of any Mold/Tool/Plates.
  - For Everyday product, if no order is received on an item in a 12-month period, items should be sent to Product Directors to confirm disposal.
  - For Seasonal product, if the Vendor has not received any new orders since 1 week after the seasonal ex-factory date from the previous year, items should be sent to the Product Director to confirm disposal.
- Receive written confirmation from the appropriate Product Director Mold/Tool/Plates can be disposed. THERE ARE NO AUTOMATIC DISPOSALS. Directors MUST confirm.
- If you are unfamiliar with who the appropriate Product Director is as it relates to the specific Mold/Tool/Plate, please contact the PCHI Asia Merchandise Team (AMT) to assist you.

**Section – 4a,c (Retail)****Electronic Data Interchange****Overview – Party City (includes Party City, Party America, and Halloween City)**

Electronic Data Interchange (EDI), with our trading partners establishes standardization of information for accurate product flow from our trading partners to our customers. It is a standard format for exchanging business data between different companies using AS2 communication for direct connects, networks, such as Value Added Networks or the Internet. The American National Standards Institute (ANSI) formed the Accredited Standards Committee (ASC) X12 to define EDI standards of communication. All Party City EDI transactions are ANSI X12 version 4010.

**All trading partners must be capable of exchanging information via Electronic Data Interchange (EDI). All Party City Corporate stores and most Franchise stores will use EDI. Franchise stores will continue to receive paper invoices.**

**All EDI Guidelines and mapping requirements are available on the Party City Vendor Website at <http://www.partycityvendors.com/>.**

There are several EDI software providers who can help provide the tools to transmit data via EDI. Party City does not require a sole source solution but offers alternatives to facilitate cost-effective electronic trade. For more information, you may contact the Party City EDI team at EDI@partycity.com.

All trading partners must communicate any modifications of their EDI or back office systems to Party City's EDI team, in writing, 60 days before such modifications are implemented. Trading partners must work with Party City's EDI Team to validate all documents affected by modifications. Failure to communicate any modifications may incur reimbursement charges as outlined in this guide. Refer to Section 10, Reimbursement and Waiver Policy.

For EDI requirements you may contact members of the Party City EDI Team via email at EDI@partycity.com.

**Benefits**

EDI eliminates supply chain inefficiencies by:

- **Improving Data Integrity:** The automated exchange of information improves data integrity by reducing human error and ensures data is complete, consistent and accurate.
- **Reducing Operational Costs:** The long-term return on investment, due in part to decreased operational expenditures and misallocated resources, offsets the initial start-up and ongoing costs of EDI.
- **Improving Customer and Trading Partner Relations:** The electronic transfer of time sensitive documents results in expedient delivery of product to store shelves, improving customer satisfaction and increasing sales.

**Section – 4a,c (Retail)****Methods of Communication**

There are three methods of communication to send and receive EDI data between Party City and our trading partners. There is a short description below of these methods. The trading partner must decide which one is applicable to their business or system capabilities. AS2 is Party City's required method of electronic trading of business documents.

**1. Direct Connection - AS2**

Direct connection with a trading partner eliminates kilo character charges and the costly expense of subscribing to a VAN. However, direct connection adds responsibilities otherwise covered by a VAN, such as: security to limit system access, and the ability to handle a variety of protocols and transmission rates. AS2 is the required method for direct connection. The trading partner is responsible for their AS2 license fees. Trading partners must provide a current AS2 certificate for communicating using AS2. It is the trading partner's responsibility to provide their updated certificate upon certificate expiration.

**2. Value Added Network (VAN)**

A Value Added Network (VAN) eliminates the need to interface with each trading partner individually. The transfer of information is analogous to correspondence one might exchange through a post office box or slot. The network accepts messages from all participants and stores them in the appropriate slots, where only the assigned users may access them. A trading partner subscribing to a VAN need only interface with the trading partner's assigned mailbox. A VAN will count kilocharacters per transaction and charge the subscriber (trading partner) for transactions being sent as well as received. **If a trading partner chooses to use a VAN, the trading partner is responsible for all kilocharacter charges for data sent and received.**

**3. Internet**

A web-based solution generally involves manual or automatic data entry onto a web form provided by a third party. Party City strongly encourages non-EDI capable trading partners to fully evaluate a web-based solution. It is a cost efficient, easy to implement, secure EDI solution minimizing ongoing transactional kilocharacter charges associated with a traditional EDI VAN provider.

Each of the aforementioned communication methods can be integrated with the trading partner's current system or exist as a stand-alone system. *Integrated systems* are able to pass data received into other applications without manual intervention. Reduced manual entry is one of the greatest Returns on Investment (ROI) of EDI. *Stand-alone systems* primarily receive data and require the trading partner to manually enter the data into other applications.

If a trading partner chooses to utilize a VAN or direct connection, software is required to translate the trading partner's internal data into the EDI format and to translate data received from a trading partner. The software also performs editing and control functions to ensure the data meets the ASC X12 specifications. A trading partner may choose to use any of the following translation software options:

- Commercial translation packages
- Core business turnkey application software including EDI translation
- Value Added Networks/service providers

**Section – 4a,c (Retail)**

**EDI Mapping Guidelines**

The EDI Mapping guidelines, located on our website at <http://www.partycityvendors.com/>, provide the requirements for each EDI transaction set and detail specifications of the data exchanged between Party City and our trading partners. Party City mandates all trading partners follow the published EDI Mapping Guidelines for each of the EDI transaction sets. Deviations from the guidelines are not acceptable. Deviations from the guidelines may result in EDI transmission failure and may incur reimbursement charges as outlined in this guide. Refer to Section 10, Reimbursement and Waiver Policy, for more information.

**EDI Transaction Sets**

Per the EDI standards, each supported document, as listed below, is given an identifier known as a Transaction Set. For instance, a Purchase Order document is referred to as "PO 850."

Party City requires all trading partners to be able to receive or send the following EDI Transaction Sets:

<b>Outbound/Inbound from Trading Partner's Point of View</b>	<b>EDI Transaction Set Number</b>	<b>Document Description</b>
Inbound	850	Purchase Order
Inbound	864	Text Message
Outbound	856	Advance Ship Notice
Outbound	810	Invoice
Outbound/Inbound	997	Functional Acknowledgement

The following websites provide useful information about EDI and the Standards:

[www.gs1us.org](http://www.gs1us.org)  
[www.ansi.org](http://www.ansi.org)

Uniform Code Council  
 American National Standards Institute

**Section – 4a,c (Retail)**

**850 Purchase Order**

The 850 transaction set is used to place purchase orders. The transaction set will not be used to convey purchase order changes or purchase order acknowledgment information. The 850 PO transaction set contains all information contained on a hard copy PO. **The quantity ordered will always be in selling units of measure.** In addition, the 850 PO will contain the terms (payment and shipping) the trading partner must use for the order. Invoicing with terms other than those contained on the 850 (PO) will be subject to reimbursement charges. **Invoices and ASN’s must reflect selling units of measure as they appear on the Purchase Order. If this is not accurate, the invoices and ASN’s will be subject to reimbursement charges.** Refer to Section 10, Reimbursement and Waiver Policy section, for more information.

POs are transmitted Monday thru Sunday, between the hours of 5 AM and 2 AM EST. Trading partners are required to transmit a 997 Functional Acknowledgement for all 850s within 24 hours of receipt.

The following are the Data fields for the 850 PO:

<b>850 (PURCHASE ORDER) DATA FIELDS</b>	
<b>Header Fields</b>	<b>Detail Fields</b>
<ul style="list-style-type: none"> <li>• PO Number</li> <li>• Buyer Code (Department Code)</li> <li>• AP Terms</li> <li>• PO Notes - 60 Char.</li> <li>• PO Date</li> <li>• Ship to - Store Name</li> <li>• Ship to - Store Number</li> <li>• Ship to - Ship Address</li> <li>• Ship to - City, State, Zip</li> <li>• Ship Via - usually TRG</li> <li>• Bill to Name and Address</li> <li>• Do not deliver before date – <u>This is NOT the ship date</u></li> <li>• Cancel if not delivered by date</li> <li>• Vendor Number</li> <li>• Vendor Name</li> <li>• FOB - CC for Collect or PP for Prepaid</li> </ul>	<ul style="list-style-type: none"> <li>• PO Line Number</li> <li>• UPC</li> <li>• Case Pack ID</li> <li>• SKU</li> <li>• Vendor Product Description</li> <li>• Qty Ordered - selling units</li> <li>• UOM</li> <li>• Unit Price - up to 4 decimals</li> <li>• Retail Price</li> <li>• Total Purchase Order Amt</li> </ul>

Please note, any issues with your Party City PO in regards to the following should be addressed by a member of the respective Merchandising team within 24 hours of receipt of documents:

- Pricing/Cost
- Vendor Item Number
- Vendor UPC
- Orders not meeting minimums
- Unavailability of product
- Cancelled POs
- Delivery date issues

**The EDI team should only be notified if there is an EDI transmission error.**

**Section – 4a,c (Retail)**

The Department code is sent on the 850 in the PER Segment. The descriptions for those Department codes are:

Dept Code	Department code description
CSTK	CASE STACK PRESENTATION
36CH	CHINESE NEW YEAR
31	CHRISTMAS
44CH	CHRISTMAS CANDY
36CI	CINCO DE MAYO
22	COMMUNION
55	COSTUME ACCESSORIES
55BK	COSTUME ACCESSORIES BULK
27BK	COSTUME BULK
27	COSTUME SHOP
EMR	EARLY MOVIE RELEASE
21	EASTER
44EA	EASTER CANDY
EVERY	EVERYDAY
28	FALL
FEDRP	FRANCHISE STORE INITIATED ED REPLENISHMENT ORDERS
23	GRADUATION
23BK	GRADUATION BULK
26	HALLOWEEN
26BK	HALLOWEEN BULK
44HA	HALLOWEEN CANDY
SEARPL	SEASONAL REPLENISHMENT
29	THANKSGIVING
64	TOYS

Dept Code	Department code description
36HR	DERBY (Horse Racing)
30	HANUKKAH
44HK	HANUKKAH CANDY
WEB	INTERNET STORE
56	MARDI GRAS
56BK	MARDI GRAS BULK
NS	NEW STORES
32	NEW YEARS
36PA	PASSOVER
24	PATRIOTIC
24BK	PATRIOTIC BULK
36PR	PRIDE
36PU	PURIM
REPLN	REPLENISH
7	SPRING
66	SPRING 2019
20	ST PATRICK'S DAY
25	SUMMER
25BK	SUMMER BULK
44SU	SUMMER SEASONAL CANDY
18	SUPERBOWL
WAC	SUPERBOWL ACIM
44VA	VAL CANDY
19	VALENTINES

Special Use Buyer Codes				
FEDAY	AMSCAN ONLY - FRANCHISE ED REPL		XBUK	ED BYPASS
FEDSO	AMSCAN ONLY - FRANCHISE SOLIDS REPL		GBUK	ED PROMOTIONS
NS11	BAKEWARE - AMSCAN ONLY		36EID	EID - (Muslim Holiday)
EDB	ED BYPASS FOR A553 ONLY		XPD	EXPEDITE
EDG1	ED GRAD BLOCK 1 SKUS		PCPS	PRODUCT SAFETY
EDG2	ED GRAD BLOCK 2 SKUS		PROMO	PROMO
NS59	PREMIUM TRIM - AMSCAN ONLY		SGP	Santa Gift Promo - Canada only
SXP	SEASONAL EXPEDITE		SML	SMALLFOOT
SEG1	SEASONAL GRAD BLOCK 1 SKUS		WASST	WHOLESALE ASSORTMENT
SEG2	SEASONAL GRAD BLOCK 2 SKUS		WTOY	WHOLESALE TOY
WEBAG	WEB ANAGRAM			

## Section – 4a,c (Retail)

### 864 Text Message

Purpose: This Document contains the format and establishes the data content of the Text Message Transaction Set (864) for use within the context of an Electronic Data Interchange (EDI) environment. The transaction set can be used to provide users with a capability to electronically move messages, contracts, explanations, and other one-time communications. It is the intent of this transaction set to provide electronic communication (messages) for people, not for computer processing. The transaction set's purpose for Party City is to provide communication to the recipient in some human-readable form to relay information regarding Product Safety Requirements. The recipient's network will dictate what capabilities are available for delivery of the information.

ISA	Interchange Control Header
GS	Functional Group Header
ST	Transaction Set Header
BMG	Beginning Segment For Text Message
DTM	Date/Time Reference
N1	Loop Name
N1	Name
REF	Reference Identification
MIT	Loop Message Identification
MIT	Message Identification
MSG	Message Text
SE	Transaction Set Trailer
GE	Functional Group Trailer
IEA	Interchange Control Trailer

**Section – 4a,c (Retail)**

**856 Advance Ship Notice**

The 856 transaction is used to provide Party City with advance data on the shipments of products so Party City may better plan workloads and receipt processing. The ship notice may be sent no later than the time the shipment leaves the trading partner’s shipping area. **The ship notice must reflect exactly the product and quantities by carton being sent on the truck as it leaves the trading partner shipping area.** Party City requires one PO be associated with each ASN, however, you may have multiple ASN’s associated to one PO. **The ship notice must arrive electronically before the physical shipment arrives at the store.** Refer to the Packaging and Packing Instructions section 5 for GS1-128 label requirements for the 856 (ASN). Please take note, batching processes may delay receipt of an ASN to Party City. Shipments received without an ASN are subject to penalties as listed in the Reimbursement and Waiver Policy, Section 10. The ship notice does not exceed the scope of the bill of lading (BOL), nor does it replace the bill of lading. All small parcel shipments must contain tracking numbers.

**Carton Level Tracking is mandatory for all parcel shipments.** Tracking numbers must be included in the ASN data for each carton at the Pack level MAN05 segment. If tracking cannot be included at the MAN05 segment, it should then be sent in the shipment level within the REF\*CN segment for just the first carton in a series. Please refer to our ASN mapping at [www.partycityvendors.com](http://www.partycityvendors.com). Click on EDI Guidelines and Specifications, 856 ship notice manifest. On the last page of the ASN mapping there is an example of carton level tracking and how it should appear at the carton level within the MAN segment. For LTL shipments, the pro tracking number must be included in the shipment level REF\*CN segment.

**In order to systematically match an ASN receiving transaction to its corresponding invoice, the Ref SI segment is a mandatory segment used to identify a received carton from a specific ASN shipment to its exact intended invoice. This is particularly useful in situations where there are multiple shipments/invoices against a single PO. The Ref SI segment must be the same for the ASN (856) and the Invoice (810) and must be unique to each shipment.**

For example:

ASN Data		
PO #	ASN Carton #	ASN Ref Si
1234567	12340000000000000001	1234567A
1234567	12340000000000000002	1234567A
1234567	12340000000000000003	1234567A
1234567	12340000000000000005	1234567B
1234567	12340000000000000006	1234567B
1234567	12340000000000000007	1234567C
1234567	12340000000000000008	1234567C

Invoice Data	
Invoice #	ASN Ref Si
98766	1234567A
98766	1234567A
98766	1234567A
98777	1234567B
98777	1234567B
98888	1234567C
98888	1234567C

**All cartons associated with an ASN must have the Party City approved GS1-128 label that matches the carton ID on the ASN.** Missing or incorrect carton labels are subject to significant reimbursement charges as defined in the Reimbursement and Waiver Policy, Section 10.

**ASNs must be received and processed by Party City prior to shipment arrival at receiving facility.** If trading partner’s ASN has not been acknowledged, trading partner must follow up



**Section – 4a,c (Retail)**

immediately to ensure the EDI document has been received at Party City prior to shipments arriving at the Party City location.

The following are the Data Fields on the 856 Advanced Ship Notice (ASN):

<b>856 (ASN) DATA FIELDS</b>	
<b>Header Fields</b>	<b>Detail Fields</b>
<ul style="list-style-type: none"> <li>• Vendor Number</li> <li>• Vendor Name</li> <li>• Shipment Number</li> <li>• Shipment Date</li> <li>• Shipped Date</li> <li>• Carrier Details</li> <li>• FOB Shipment Method of Payment</li> <li>• FOB Description</li> <li>• Ship Point Zip Code</li> <li>• Scheduled Receipt Date</li> <li>• Pro Number or Tracking Number</li> <li>• Bill of Lading Number</li> <li>• Invoice Number - optional</li> <li>• Number of Cartons</li> <li>• Weight</li> <li>• SCAC Code</li> <li>• Ship to Store Number</li> <li>• Ship to Address</li> <li>• PO Number</li> <li>• Shipment to Invoice ID (REF*SI)</li> <li>• PO Date</li> <li>• FOB - CC for Collect or PP for Prepaid</li> </ul>	<ul style="list-style-type: none"> <li>• Carton Number &amp; Tracking (Pack Level)</li> <li>• Line Number</li> <li>• Vendor Item Number</li> <li>• UPC</li> <li>• QTY – as appears on PO</li> <li>• Unit of Measure – selling unit of measure</li> </ul>

**Section – 4a,c (Retail)**

**810 Invoices**

The 810 Invoice is used for the billing of goods shipped. All Corporate purchase orders received via EDI, must be invoiced using the 810 EDI transaction containing the following information:

**The Ref Si segment in the ASN must match the REF SI segment on the Invoice and must be unique to each shipment. Each Invoice will have the Ref SI populated to match to its specific ASN shipment. That Ref SI field identifier should only be used for a PO one time and be included on the ASN and the Invoice. A new Ref SI number will be needed for any subsequent shipments against a PO and included on both the ASN and the Invoice.**

**All Franchise invoices must be manually sent to the Franchisee.**

<b>810 (Invoice) Data Fields</b>	
<b>Header Fields:</b>	<b>Detail Fields</b>
<ul style="list-style-type: none"> <li>• Invoice Date</li> <li>• Invoice number</li> <li>• PO Date</li> <li>• PO Number</li> <li>• Shipment to Invoice ID (REF*SI)</li> <li>• Ship to Name</li> <li>• Ship to Store Number</li> <li>• Vendor Name</li> <li>• Vendor Number</li> <li>• Terms Discount Percent</li> <li>• Terms Discount Due Date</li> <li>• Terms Net Due Date</li> <li>• Terms Description (Exact Description from 850 Document)</li> <li>• Terms Discount Days</li> <li>• Terms Net Days</li> <li>• Invoice Notes</li> <li>• Transaction Set Purpose Code</li> <li>• Date Shipped</li> <li>• FOB Method</li> <li>• FOB Description</li> <li>• Bill of Lading/ PRO Number</li> <li>• SCAC Code</li> </ul>	<ul style="list-style-type: none"> <li>• Line Sequence Number</li> <li>• Quantity – as appears on PO</li> <li>• Selling Unit of Measure (UOM)</li> <li>• Unit Price</li> <li>• Vendor Item Number</li> <li>• UPC</li> <li>• Allowance or Charge Indicator</li> <li>• Allowance Code</li> <li>• Allowance/Charge Amount</li> <li>• Method of Handling</li> <li>• Total Invoice Amount – including charges and allowances</li> <li>• Invoice Amount – before charges and allowances</li> <li>• Transportation Code</li> <li>• Number of Units Shipped</li> <li>• Routing</li> <li>• Weight</li> </ul>

**Transmission Errors**

When errors are detected on inbound EDI documents, our trading partner will be notified. After notification, our trading partner is required to correct and re-send the documents within 24 hours. Our trading partner must notify Party City the corrected documents have been re-sent.

**Section – 4a,c (Retail)****997 Functional Acknowledgement**

Functional Acknowledgements (FA) are required for each functional group transmitted. The FA must be sent by the receiver of the functional group, to the sender, by the close of the next business day after receipt. The FA transaction provides a positive response informing the sender if the contents of the transmission are syntactically correct. *Failure to transmit acknowledgements within specified time will result in reimbursement charges being assessed in accordance with the Reimbursement and Waiver Policy Section 10.* If there is a problem with a transmission, the vendor must contact the Party City EDI team by close of business on the next business day after receipt of transmission to identify issues if they exist. The FA is not an acknowledgement of any application data such as terms, discounts, SKU or UPC numbers.

**Failure to transmit acknowledgements or notify the EDI team of any issues within the specified time may result in reimbursement charges being assessed in accordance with the Reimbursement and Waiver Policy in Section 10.**

**Getting Started****Exchange of EDI and AS2 information**

The first step in setting up the trading partner relationship is the EDI TP Questionnaire that is located on our website at <http://www.partycityvendors.com/>, under the section EDI Specifications and Guidelines. This form must be filled out and sent to the EDI Team. Please send the form to EDI@partycity.com. If EDI is outsourced, please consult your provider when completing the AS2 portion of the form. Please note the AS2 certificate is part of the information exchange.

A test schedule will need to be established to meet the two week requirement for completion of testing AS2 connectivity, 850, 810, 856, and 997 and providing a copy of the GS1-128 label.

A complete system test is required with the trading partner and Party City verifying the accuracy of the exchange of data. This test also determines compliance with any unique conditions that have been mutually agreed upon by the partners.

From a technical standpoint, the purpose of the complete system test is to verify the following capabilities:

- The ability to send and receive transmissions to and from the trading partner
- The translation of documents to and from trading partner
- The ability to process the output from the translation process
- The generation of the Functional Acknowledgment (997)
- GS1-128 Label compliance

The testing process will consist of Party City sending an 850 (PO) to verify the data is correct and the mapping is able to translate the data correctly. The 850 (PO) must be accepted and the 997 Functional Acknowledgement returned to Party City. Additionally, Party City requires each PO/shipment be accompanied by the 856 (ASN) and the 810 (Invoice) EDI documents and the GS1-128 label that would be attached to each carton matching data sent via EDI in the 856 transmission.



HALLOWEEN CITY®



## Section – 4a,c (Retail)

Testing is complete after all parties have agreed to the successful exchange of data and verification of the data and the GS1-128 label. The EDI live date will be then established to trade documents in production.

Once in production, chargebacks for non-compliance will be assessed for failure to transmit any documents via EDI, **in accordance with the Reimbursement and Waiver Policy in Section 10.**

## Section - 5a,c (Retail)

## Packaging &amp; Packing Instructions

**Overview – Party City (includes Party City, Party America, and Halloween City)**

As business partners driving mutually beneficial supply chain efficiencies, this section contains detailed instructions on packaging, carton labeling and marking, and shipment documentation for merchandise shipped to Party City. Party City is committed to working with our vendor partners to improve product packaging/handling and to increase automation efforts.

It is expected all vendors will comply with the requirements set forth in this Vendor Standards Manual. Non-compliance will result in reimbursements to Party City for processing expenses incurred due to non-compliance. Reimbursements are outlined in Reimbursement and Waiver Policy, Section 10.

All labels applied directly to product must include a removable adhesive so product is not damaged. Placement of labels should not block the UPC or otherwise interfere with operating or product care instructions, as well as any other pertinent product information. For more information regarding item packaging, see *Item UPC Label Guidelines* within Merchandise Information, Section 3.

**Packaging Instructions for Merchandise**

In order to expedite the receiving of cartons and maintain a high level of accuracy in processing, the following guidelines have been established:

- Only one PO per carton is permitted.
- Each selling unit must contain a valid, scannable, Universal Product Code (UPC) clearly visible and affixed.
- Carton weight should not exceed 45 pounds, unless the product itself weighs more than 45 pounds. If so, a sticker indicating the product exceeds 45 pounds must be attached and clearly visible.
- Seal shipping cartons with tape or light adhesive. Do not use staples or bands.
- Package merchandise in new sturdy cartons capable of withstanding normal shipping and handling.
- PO should be shipped utilizing the least number of cartons while maintaining shipping container integrity and not incurring additional freight charges.
- Do not use loose fill in shipments such as foam chips, shredded paper or straw like material without obtaining prior written approval from the Party City/Amscan Logistics Department. If approval is obtained, clearly identify on the cases with loose fill, in clear writing, that **"loose fill is contained within"**.
- Location address, including store number, and PO number are to be CLEARLY marked on the outside of each carton. A Party City approved GS1-128 label is required for all DSD shipments for corporate stores.
- When multiple carton shipments are made, cartons are to be marked 1 of X, 2 of X, X of X...
- Packing slip is to be enclosed in or affixed to the lead or last carton. If it is enclosed within a carton, the carton must be clearly labeled indicating the packing slip is enclosed. Clearly labeled is defined as a label with a minimum size of 2" x 3" and lettering of at least a size 22 font. Multiple PO's shipped on the same day must be packed individually.

**Section - 5a,c (Retail)**

**Unless granted advance written approval from the Party City/Amscan Logistics Department, shipments not meeting the minimal requirements may be refused upon delivery and returned to the vendor at the vendor's expense. When shipping small packages consolidate to the largest carton size available to minimize # of cartons shipped. Only master cartons should have the GS1-128 label, containing information for all inner cartons.**

**CONEG: Packaging Requirement**

Manufacturers and suppliers of packaging and packaging components are required by law to furnish a certificate of compliance to customers upon request (refer to the introduction section). This applies only to companies who actually put their products in the package and does not apply to the retailer or the individual consumer. The public and state also have access to these certificates.

Should there be any problems after cartons are received, or there is non-compliance with the above criteria, a redesign will be done to comply. Watch this very carefully so that this process and potential chargebacks can be avoided. Failure to meet the Quality Control guidelines will result in penalties as listed in Reimbursement And Waiver Policy, Section 10, and Terms and Conditions, Section 2.

**Traceability**

**Children's products will need permanent distinguishing marks on the product, to the extent practicable, to identify the manufacturer, location, date of production and other necessary information for all goods manufactured on or after 8/14/09.**

**Marking/Labeling of Cartons**

Party City's EDI Team will oversee the approval of the GS1-128 label. Vendors must follow these guidelines for labeling cartons:

Prior to ASN Certification, vendors must include the following on their labels:

- Store Number
- Purchase Order Number
- Store Name and Address
- When multiple carton shipments are made, cartons are to be marked 1 of X, 2 of X, X of X.
- All master cartons must be clearly marked with a label no smaller than 2" x 3" and no larger than 3" x 4" containing the department description, such as: Halloween, Valentine's Day, Replenishment, Everyday, etc. For example, Halloween merchandise should read, "HALLOWEEN" on the outside of the carton. The font must be no smaller than 48 point font and must fit on the label used.

Upon ASN Certification, vendors are responsible for the following:

Effective for all shipments on the date of ASN certification, carton labels for all Party City shipments must be a 4" x 6" GS1-128 shipping label. Each vendor is responsible for supplying GS1-128 labels (as outlined later in this section). These labels may be made in-house with bar-code software or vendors may outsource this responsibility. Party City reserves the right to make future label changes should it be deemed necessary.

**Section - 5a,c (Retail)**

ASN Certified vendor labels must include the following:

- All Party City Purchase Order (PO) numbers must not be modified and must be human readable.
- All Party City SKUs must be human readable.
- The quantity must always be human readable. The quantity must reflect the number of selling units. For example, if shipping 24 units of an item, the quantity would be 24. No decimals are used.
- The Party City department number must be human readable. The Department No. is provided on all Party City POs. If unclear of the Department No., contact the Party City Planning and Allocations team to identify the Department No.
- GS1-128 labels must be placed on the lower right hand corner of the longest side of the master carton approximately two inches from the carton edges. There should be no labels on the inner cartons. All ASN information for inner cartons should be contained under the label on the master carton.
- Each carton must only have one GS1-128 label
- When multiple carton shipments are made, cartons are to be marked 1 of X, 2 of X, X of X...
- All merchandise must be clearly marked with the department description, such as: Halloween, Valentine's Day, Replenishment, Everyday, etc. For example, Halloween merchandise should read, "HALLOWEEN" in box 5 of the GS1-128 label. The font must be no smaller than 48 point font and must fit on the label used. Refer to the label format examples in this section for more information. If unclear of the department, contact the Party City Planning and Allocations team.

The department information is sent on an 850 EDI PO in the PER Segment as a Department Code. Here are some examples of how we send the Department code over in the EDI 850 Purchase Order:

Example 1: PER\*BD\*REPLN The Dept code is REPLN which relates to the description REPLEN or REPLENISHMENT. The description should be placed in box 5 of the GS1-128 label. Box 6 should contain the Dept code REPLN.

Example 2: PER\*BD\*PCPS The Dept code is PCPS which relates to the description PRODUCT SAFETY which should be placed in box 5 of the GS1-128 label. Box 6 should contain the Dept code PCPS.

Example 3: PER\*BD\*26 The Dept code is 26 which relates to the description HALLOWEEN which should be placed in box 5 of the GS1-128 label. Box 6 should contain the Dept code 26.

See the full list of Dept codes and descriptions in Section 4 (Retail).

**Section - 5a,c (Retail)**



**Label Format**

Labels must include the following information and must be in the format specified by Party City. Remember to include the field identifier numbers when bar-coding.



BOX 1	FROM	Vendor name and address where the merchandise ships from
BOX 2	TO	"Party City", store number, address and zip code that merchandise is being sent to or the destination as specified on the PO. *May be waived for HC. This will be communicated and documented.
BOX 3	SHIP TO POST	Ship to zip code must be human readable and bar-coded.
BOX 4	CARRIER INFORMATION	SCAC code and one of the following: Tracking number, PRO number, Bill of Lading (BOL) number. *May be waived for HC. This will be communicated and documented.
BOX 5	DENOTE DEPARTMENT DESCRIPTION	The vendor must input the department description. Department Code is obtained from the PO.
BOX 6	DEPARTMENT	Party City department in which the vendor product is categorized. Department information is obtained from PO.
BOX 7	SKU UPC DESCRIPTION OR MIXED	The Party City SKU number must be human readable. Should also contain UPC and the Party City Item description. If more than one SKU per carton, the SKU should read "MIXED", UPC should be blank, and the Description should be blank.
BOX 8	PO NUMBER PARTY CITY VENDOR NUMBER	The PO# appearing on the Party City PO. PO# must be human readable. The vendor number is the Party City assigned vendor number.
BOX 9	QUANTITY	The quantity must be human readable. The quantity is the total number of selling units in a carton. Field must be blank if more than one SKU in carton.
BOX 10	MARKED FOR	Final destination of the merchandise. The store number is four digits in length, must be human readable. Must use the full address of the final destination. Please use larger font for store no. (48). *May be waived for HC. This will be communicated and documented.
BOX 11	SSCC-18 STANDARD GS1-128 BAR CODE	Carton serial number, which must be unique and never repeated on any cartons or shipments. This must be human readable and bar-coded for a total of 20 digits. "00" is the application identifier. Position 18- must use "0" to indicate the shipping container is a case or carton. Position 17 – "0" indicates your company has a unique number assigned by the UCC. Positions 16 through 11 - indicate the unique number assigned to your company by the UCC. Positions 10 through 2 – indicate the sequential numbering of cartons, unique for each carton and not repeated for 2 years. Position 1 – Modulo 10 check digit.



**Party City GS1-128 Label Format**  
**Carton Label Requirements**  
Single SKU Label Format  
 For Direct to Store Shipments

Box 1	<b>From:</b>  XYZ Party Supply 123 Party Place Anytown, NJ 07866	<b>To:</b>  Party City Store #0012 321 Main St. Anytown, NJ 07866	Box 2
Box 3	07866 	<b>Carrier Information</b>	Box 4
Box 5	<h1>Halloween</h1>		
Box 6	<b>Dept. 26</b>	SKU: 12345	Box 7
Box 8	PO #: 123456789	UPC: 021300147097	
	Vendor #: 111	Description: Party City Item	
Box 9	<b>Quantity</b> 0024	<h1>#0012</h1> 321 Main St Anytown, NJ 07866	Box 10
	 (00) 0 06 14141 123456789 0		Box 11

**Party City GS1-128 Label Format**  
**Carton Label Requirements**  
Multi - SKU Label Format  
 For Direct to Store Shipments

Box 1	<b>From:</b> XYZ Party Supply 123 Party Place Anytown, NJ 07866	<b>To:</b> Party City Store #0012 321 Main St. Anytown, NJ 07866	Box 2
Box 3	<b>07866</b> 	<b>Carrier Information</b>	Box 4
Box 5	<h1>Halloween</h1>		
Box 6	<b>Dept. 26</b>	SKU: MIXED	Box 7
Box 8	<b>PO #: 123456789</b>	UPC:	
	<b>Vendor #: 111</b>	Description:	
Box 9	<b>Quantity</b>	<h1>#0012</h1> 321 Main St Anytown, NJ 07866	Box 10
	 (00) 0 06 14141 123456789 0		Box 11



**Party City GS1-128 Label Format**

**Carton Label Requirements**

Single SKU Label Format

For "Ship To - Marked For" Shipments

(By-Pass or Consolidation)

Box 1	<b>From:</b> XYZ Party Supply 123 Party Place Anytown, NJ 07866	<b>To:</b> Party City Store #0999 123 State St. Anytown, PA 06543	Box 2
Box 3	<b>06543</b> 	<b>Carrier Information</b>	Box 4
Box 5	<h1>Halloween</h1>		
Box 6	<b>Dept. 26</b>	SKU: 12345	Box 7
Box 8	<b>PO #: 123456789</b>	UPC: 021300147097	
	<b>Vendor #: 111</b>	Description: Party City Item	Box 10
Box 9	<b>Quantity</b> 24	<b>#0012</b> 321 Main St Anytown, NJ 07866	
	 (00) 0 06 14141 123456789 0		Box 11



**Party City GS1-128 Label Format**

**Carton Label Requirements**

Multi-SKU Label Format

For "Ship To - Marked For" Shipments

(BY-Pass or Consolidation)

Box 1	<b>From:</b> XYZ Party Supply 123 Party Place Anytown, NJ 07866	<b>To:</b> Party City Store #0999 321 Main St. Anytown, NJ 07866	Box 2
Box 3	<b>06543</b> 	<b>Carrier Information</b>	Box 4
Box 5	<b>Halloween</b>		
Box 6	<b>Dept. 26</b>	SKU: MIXED	Box 7
Box 8	<b>PO #: 123456789</b>	UPC:	
	<b>Vendor #: 111</b>	Description:	
Box 9	<b>Quantity</b>	<b>#0012</b> 321 Main St Anytown, NJ 07866	Box 10
	 (00) 0 06 14141 123456789 0		Box 11

## Section - 5a,c (Retail)

### Packing Slips

Party City requires a packing slip for all shipments. Only 1 packing slip per PO # shipped. The packing slip must contain the following information:

- Party City PO number
- Party City Store Number
- Number of cartons
- Item descriptions, SKU # (only if EDI certified)
- Item quantities
- Grand total units

For common carrier shipments, insert packing slips into a removable pouch and place on the outside of a "Lead Carton" (1 of X) or "Last Carton" (X of X) for each shipment. Indicate "Lead Carton" on carton or place in a "Packing Slip Enclosed" preprinted pouch. In addition, the packing slip can be placed inside a "Lead Carton" or "Last Carton" where the carton is clearly labeled "Packing Slip Enclosed" on the outside of the carton. The carton containing the packing slip must be placed on the top layer of the pallet with the clearly marked "Packing Slip Enclosed" area facing out. Each Bill of Lading must be marked with the actual carton count.

For parcel shipments, the carton labeled 1 of X is the "Lead Carton," and the carton labeled X of X is the "Last Carton." Follow the instructions described above for packing slip placement.



## Section – 5b (Wholesale)

### Packaging & Packing Instructions

#### Overview

This section outlines the packaging and packing requirements for Party City Holdings Inc (PCHI) wholesale consisting of Amscan and Anagram International unless stated otherwise.

#### TOPS

Packaging is designed using Total Optimization Packaging Software (TOPS). Every new product is put through the TOPS program to determine the most efficient use of space (dimensions), as well as effective carton weight. The program will generate several inner and master carton packaging options and pallet designs based on desired parameters.

For most products, only one each is available for packaging design. In this case, estimated packaging dimensions and weights **will be generated**. This packaging is developed as a guideline to illustrate our desired inner pack quantity and orientation in the master carton. Flap orientation of the master carton is important. A 1" variance in any dimension on the master carton is acceptable. If your packaging is not within this tolerance, please contact the TOPS Engineer with the suggested dimensions. The recommendations will be evaluated for acceptance or **a new recommendation will be given for** the master carton based on the inner pack dimensions. **These dimensions must be approved by Amscan prior to purchasing packaging materials so that potential changes can be made to the packaging starting with the first purchase order.** In any case where there is differing information on the Amscan purchase order, please contact the product manager and the TOPS Engineer to confirm the correct quantities.

#### Pallet Loads – Applies to Domestic shipments only

**Palletized loads are not to exceed the maximum height of 54" including the pallet.** Any items requiring pallet stacks higher than 54" must get approval from the Amscan Distribution Center Receiving Manager, Bill Bennett, prior to shipping. Only GMA standard wooden pallets 40" x 48" grade B or higher should be used.

A variance of 1" in one or more dimensions of the master carton may not allow for the desired pallet configuration. There should be no overhang front to back; there can be some overhang side-to-side but no more than 1" unless otherwise approved. All pallet loads should be secured and wrapped appropriately for the product to arrive at the Distribution Center intact. Double stacked pallet loads are acceptable for domestic shipments, unless damages are occurring. Amscan may exercise the right to require vendors to single stack, add corner supports, slip-sheets, or other securing methods for future shipments; this will minimize your damages and enable us to lessen the double handling of product. In the event shipments arrive at the DC and are not compliant with Pallet load specifications, damaged or require restacking, vendors will be charged back for additional handling and/or the shipment refused.



## Section – 5b (Wholesale)

### How to read a TOPS form

Once a TOPS form has been created, it will be emailed to the Vendor by the TOPS Engineer. The Vendor will need to review the TOPS form and advise the TOPS Engineer that the packing is approved. If not approved, contact the TOPS Engineer to resolve any problems before the item is shipped to avoid any penalties.

TOPS examples are shown on the next three pages. The first page is in English units of measure (inches and pounds) and the second page is in Metric units of measure (millimeters and kilograms).

Section **A** shows the packing of the eaches in the inner carton and identifies the number of eaches per inner. The dimensions are also listed. In the example, the eaches are packed in a polybag inner. If the eaches are in a corrugate inner box, this will be visible in the picture.

Section **B** shows the packing of the inners in the master carton and lists the number of inners per master. The dimensions are also listed. The master carton will always be shown as corrugate carton. Please note the orientation of the inners in the master.

Section **C** is only for vendors shipping product to us on pallets and for warehouse use. All foreign vendors can disregard this section.

Section **D** is a summary of the carton information. "Carton (OD)" is the measurements of inner carton. "Shipper (OD)" is the measurements of the master carton. (Ln = Length, Wd=Width, Ht=Height, and Grs=Gross Weight)

Notes: Any additional packing notes are listed in this section. If the inner is a polybag, this will be noted in this section. This section will list all of the items that this form applies to.

The third page shows an example where the number of eaches in the inner is equal to the number of eaches in the master. Since there are no inner cartons, only the master carton is shown. This carton should have a master carton label with a 300 series (inner carton) barcode.

Please contact the appropriate TOPS Engineer for any questions concerning packing requirements that are not listed in the TOPS form.

#### **Amscan TOPS Engineer**

E-mail : [tops@amscan.com](mailto:tops@amscan.com)

#### **Anagram International TOPS Engineer**

Cory Evans

E-Mail: [cevans@anagramintl.com](mailto:cevans@anagramintl.com)

Phone: 952-949-5692

#### **Anagram International TOPS Manager**

Tina Outlaw

E-Mail: [toutlaw@anagramintl.com](mailto:toutlaw@anagramintl.com)

Phone: 952-949-5636

**Section – 5b (Wholesale)**

**EXAMPLE OF ACTUAL TOPS FORMS**

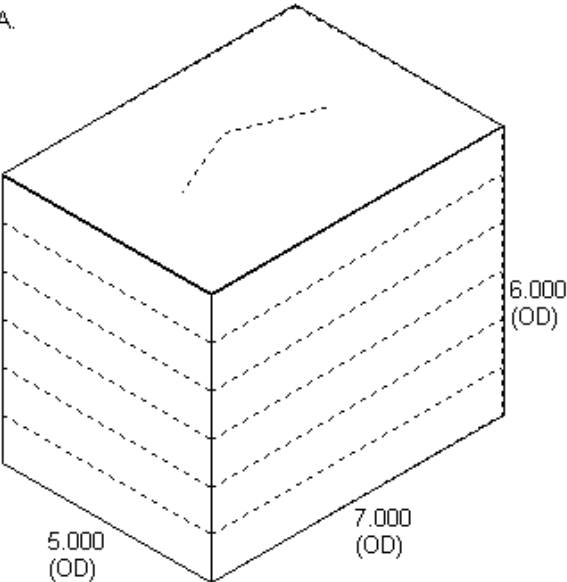
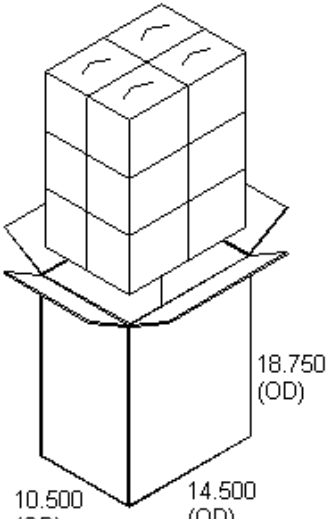
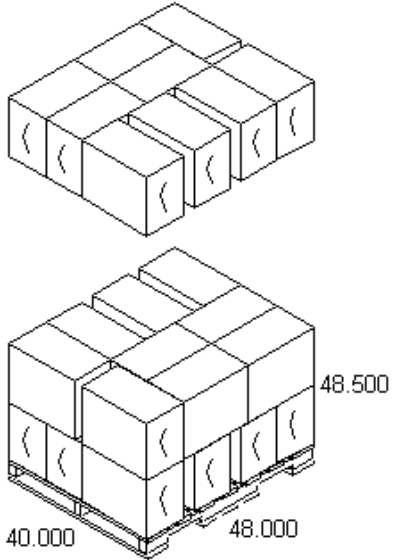
 <b>TOPS</b>	123456-PARTY ITEM	Date Printed : 1/27/2012 Last Saved : 1/27/2012																																																																															
Tops Engineering																																																																																	
<p>A.</p>  <p style="text-align: center;">6 EACHES PER INNER POLYBAG</p>	<p>B.</p>  <p style="text-align: center;">12 INNERS PER MASTER CARTON</p>																																																																																
<p>C.</p> 	<p>D.</p> <table border="1" style="width: 100%; border-collapse: collapse;"> <thead> <tr> <th></th> <th>Carton (OD)</th> <th>Shipper (OD)</th> <th>UnitLoad (Incl. Pal)</th> </tr> </thead> <tbody> <tr> <td>GMA (Notched) 48.000x40.000x5.000</td> <td></td> <td></td> <td></td> </tr> <tr> <td>Ln:</td> <td>7.000 in</td> <td>14.500 in</td> <td>48.000 in</td> </tr> <tr> <td>Wd:</td> <td>5.000 in</td> <td>10.500 in</td> <td>40.000 in</td> </tr> <tr> <td>Ht:</td> <td>6.000 in</td> <td>18.750 in</td> <td>48.500 in</td> </tr> <tr> <td>Net:</td> <td>0.000 lb</td> <td>0.000 lb</td> <td>0.000 lb</td> </tr> <tr> <td>Grs:</td> <td>2.643 lb</td> <td>32.728 lb</td> <td>948.646 lb</td> </tr> <tr> <td>Cube:</td> <td>210.000 in<sup>3</sup></td> <td>1.652 ft<sup>3</sup></td> <td>53.889 ft<sup>3</sup></td> </tr> <tr> <td></td> <td>Height Vert</td> <td>Height Vert</td> <td></td> </tr> <tr> <td>Prod.Vol:</td> <td>0.000 in<sup>3</sup></td> <td>0.000 in<sup>3</sup></td> <td>0.000 ft<sup>3</sup></td> </tr> <tr> <td>Carton:</td> <td></td> <td>12</td> <td>324</td> </tr> <tr> <td>Shipper:</td> <td></td> <td></td> <td>27</td> </tr> <tr> <td>Area Efficiency:</td> <td></td> <td>96.9 %</td> <td>92.3 %</td> </tr> <tr> <td>Cubic Efficiency:</td> <td></td> <td>96.2 %</td> <td>81.9 %</td> </tr> <tr> <td>Prod.Eff:</td> <td>0.0 %</td> <td>0.0 %</td> <td>0.0 %</td> </tr> <tr> <td>Cases per layer:</td> <td></td> <td></td> <td>9</td> </tr> <tr> <td>Layers/load:</td> <td></td> <td></td> <td>3</td> </tr> <tr> <td>Pattern:</td> <td></td> <td>2x2x3</td> <td>Triblock</td> </tr> <tr> <td>Max UL High:</td> <td></td> <td></td> <td>4</td> </tr> <tr> <td>Clamp Direction:</td> <td></td> <td></td> <td>N/A</td> </tr> </tbody> </table>		Carton (OD)	Shipper (OD)	UnitLoad (Incl. Pal)	GMA (Notched) 48.000x40.000x5.000				Ln:	7.000 in	14.500 in	48.000 in	Wd:	5.000 in	10.500 in	40.000 in	Ht:	6.000 in	18.750 in	48.500 in	Net:	0.000 lb	0.000 lb	0.000 lb	Grs:	2.643 lb	32.728 lb	948.646 lb	Cube:	210.000 in <sup>3</sup>	1.652 ft <sup>3</sup>	53.889 ft <sup>3</sup>		Height Vert	Height Vert		Prod.Vol:	0.000 in <sup>3</sup>	0.000 in <sup>3</sup>	0.000 ft <sup>3</sup>	Carton:		12	324	Shipper:			27	Area Efficiency:		96.9 %	92.3 %	Cubic Efficiency:		96.2 %	81.9 %	Prod.Eff:	0.0 %	0.0 %	0.0 %	Cases per layer:			9	Layers/load:			3	Pattern:		2x2x3	Triblock	Max UL High:			4	Clamp Direction:			N/A
	Carton (OD)	Shipper (OD)	UnitLoad (Incl. Pal)																																																																														
GMA (Notched) 48.000x40.000x5.000																																																																																	
Ln:	7.000 in	14.500 in	48.000 in																																																																														
Wd:	5.000 in	10.500 in	40.000 in																																																																														
Ht:	6.000 in	18.750 in	48.500 in																																																																														
Net:	0.000 lb	0.000 lb	0.000 lb																																																																														
Grs:	2.643 lb	32.728 lb	948.646 lb																																																																														
Cube:	210.000 in <sup>3</sup>	1.652 ft <sup>3</sup>	53.889 ft <sup>3</sup>																																																																														
	Height Vert	Height Vert																																																																															
Prod.Vol:	0.000 in <sup>3</sup>	0.000 in <sup>3</sup>	0.000 ft <sup>3</sup>																																																																														
Carton:		12	324																																																																														
Shipper:			27																																																																														
Area Efficiency:		96.9 %	92.3 %																																																																														
Cubic Efficiency:		96.2 %	81.9 %																																																																														
Prod.Eff:	0.0 %	0.0 %	0.0 %																																																																														
Cases per layer:			9																																																																														
Layers/load:			3																																																																														
Pattern:		2x2x3	Triblock																																																																														
Max UL High:			4																																																																														
Clamp Direction:			N/A																																																																														
<p>Notes: Inner is a 3 mil polyethylene bag. Close and securely tape the polybag to prevent the eaches from falling out. Master carton must be able to pass a 200 lbs/in<sup>2</sup> bursting test or a 48 lbs per inch edge crush test. All measurements are approximate.</p>																																																																																	
NETTIE FROHNHOEFER																																																																																	

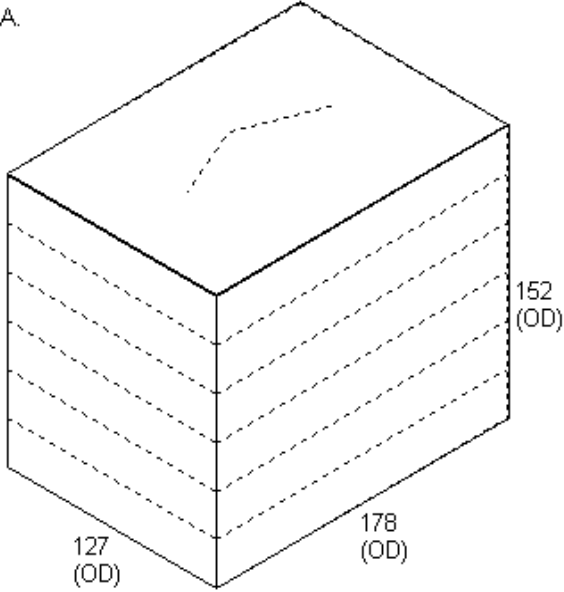
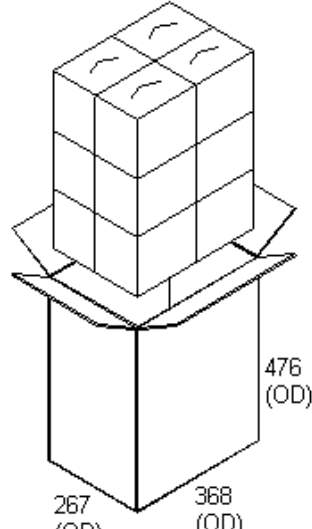
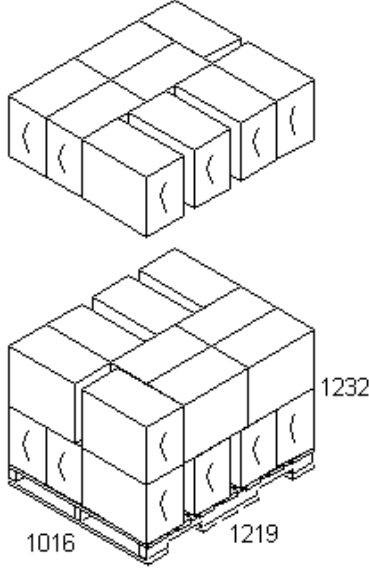

**Section – 5b (Wholesale)**

 <b>Tops Engineering</b>	<b>123456-PARTY ITEM</b>	Date Printed : 1/27/2012 Last Saved : 1/27/2012																																																																											
<p><b>A.</b></p>  <p style="text-align: center;"><b>6 EACHES PER INNER POLYBAG</b></p>	<p><b>B.</b></p>  <p style="text-align: center;"><b>12 INNERS PER MASTER CARTON</b></p>																																																																												
<p><b>C.</b></p> 	<p><b>D.</b></p> <p style="text-align: center;">GMA (Notched) 1219x1016x127</p> <table border="1" style="width: 100%; border-collapse: collapse; text-align: center;"> <thead> <tr> <th></th> <th>Carton (OD)</th> <th>Shipper (OD)</th> <th>UnitLoad (Incl. Pal)</th> </tr> </thead> <tbody> <tr> <td>Ln:</td> <td>178 mm</td> <td>368 mm</td> <td>1219 mm</td> </tr> <tr> <td>Wd:</td> <td>127 mm</td> <td>267 mm</td> <td>1016 mm</td> </tr> <tr> <td>Ht:</td> <td>152 mm</td> <td>476 mm</td> <td>1232 mm</td> </tr> <tr> <td>Net:</td> <td>0 kg</td> <td>0 kg</td> <td>0 kg</td> </tr> <tr> <td>Grs:</td> <td>1 kg</td> <td>15 kg</td> <td>430 kg</td> </tr> <tr> <td>Cube:</td> <td>3 l</td> <td>0 m3</td> <td>2 m3</td> </tr> <tr> <td></td> <td>Height Vert</td> <td>Height Vert</td> <td></td> </tr> <tr> <td>Prod.Vol:</td> <td>0 l</td> <td>0 l</td> <td>0 m3</td> </tr> <tr> <td>Carton:</td> <td></td> <td>12</td> <td>324</td> </tr> <tr> <td>Shipper:</td> <td></td> <td></td> <td>27</td> </tr> <tr> <td>Area Efficiency:</td> <td></td> <td>96.9 %</td> <td>92.3 %</td> </tr> <tr> <td>Cubic Efficiency:</td> <td></td> <td>96.2 %</td> <td>81.9 %</td> </tr> <tr> <td>Prod.Eff:</td> <td>0.0 %</td> <td>0.0 %</td> <td>0.0 %</td> </tr> <tr> <td>Cases per layer:</td> <td></td> <td></td> <td>9</td> </tr> <tr> <td>Layers/load:</td> <td></td> <td></td> <td>3</td> </tr> <tr> <td>Pattern:</td> <td></td> <td>2x2x3</td> <td>Triblock</td> </tr> <tr> <td>Max UL High:</td> <td></td> <td></td> <td>4</td> </tr> <tr> <td>Clamp Direction:</td> <td></td> <td></td> <td>N/A</td> </tr> </tbody> </table>		Carton (OD)	Shipper (OD)	UnitLoad (Incl. Pal)	Ln:	178 mm	368 mm	1219 mm	Wd:	127 mm	267 mm	1016 mm	Ht:	152 mm	476 mm	1232 mm	Net:	0 kg	0 kg	0 kg	Grs:	1 kg	15 kg	430 kg	Cube:	3 l	0 m3	2 m3		Height Vert	Height Vert		Prod.Vol:	0 l	0 l	0 m3	Carton:		12	324	Shipper:			27	Area Efficiency:		96.9 %	92.3 %	Cubic Efficiency:		96.2 %	81.9 %	Prod.Eff:	0.0 %	0.0 %	0.0 %	Cases per layer:			9	Layers/load:			3	Pattern:		2x2x3	Triblock	Max UL High:			4	Clamp Direction:			N/A
	Carton (OD)	Shipper (OD)	UnitLoad (Incl. Pal)																																																																										
Ln:	178 mm	368 mm	1219 mm																																																																										
Wd:	127 mm	267 mm	1016 mm																																																																										
Ht:	152 mm	476 mm	1232 mm																																																																										
Net:	0 kg	0 kg	0 kg																																																																										
Grs:	1 kg	15 kg	430 kg																																																																										
Cube:	3 l	0 m3	2 m3																																																																										
	Height Vert	Height Vert																																																																											
Prod.Vol:	0 l	0 l	0 m3																																																																										
Carton:		12	324																																																																										
Shipper:			27																																																																										
Area Efficiency:		96.9 %	92.3 %																																																																										
Cubic Efficiency:		96.2 %	81.9 %																																																																										
Prod.Eff:	0.0 %	0.0 %	0.0 %																																																																										
Cases per layer:			9																																																																										
Layers/load:			3																																																																										
Pattern:		2x2x3	Triblock																																																																										
Max UL High:			4																																																																										
Clamp Direction:			N/A																																																																										
<p><b>Notes:</b> Inner is a 3 mil polyethylene bag. Close and securely tape the polybag to prevent the eaches from falling out. Master carton must be able to pass a 200 lbs/in2 bursting test or a 48 lbs per inch edge crush test. All measurements are approximate.</p>																																																																													
<small>NETTIE FROHNHOEFER</small>																																																																													

**Section – 5b (Wholesale)**



Tops Engineering

123456-PARTY ITEM

Date Printed : 1/27/2012

Last Saved : 1/27/2012

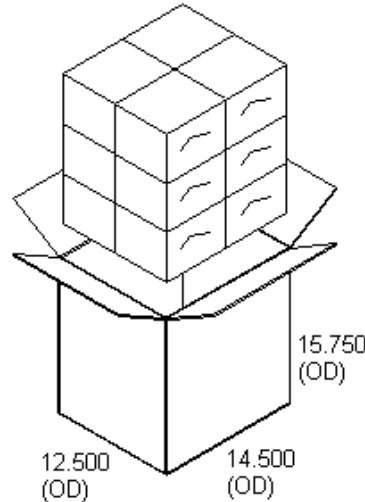

12 EACHES PER INNER, INNER CARTON = MASTER CARTON

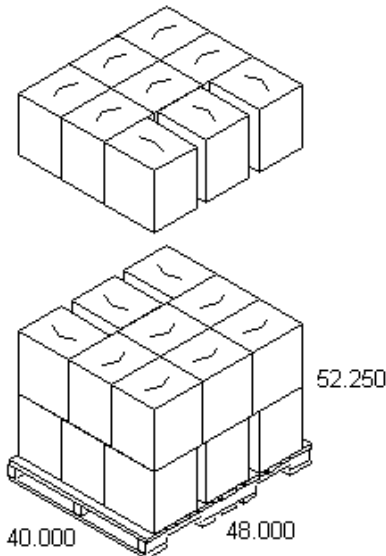

GMA (Notched) 48.000x40.000x5.000

	Carton (OD)	Shipper (OD)	Unit Load (Incl. Pal)
Ln:	7.000 in	14.500 in	48.000 in
Wd:	5.000 in	12.500 in	40.000 in
Ht:	6.000 in	15.750 in	52.250 in
Net:	0.000 oz	0.000 lb	0.000 lb
Grs:	16.000 oz	13.059 lb	417.603 lb
Cube:	210.000 in <sup>3</sup>	1.652 ft <sup>3</sup>	58.056 ft <sup>3</sup>
	Width Vert	Height Vert	
Prod.Vol:	0.000 in <sup>3</sup>	0.000 in <sup>3</sup>	0.000 ft <sup>3</sup>
Carton:		12	324
Shipper:			27
Area Efficiency:		97.2 %	85.0 %
Cubic Efficiency:		96.4 %	81.9 %
Prod.Eff:	0.0 %	0.0 %	0.0 %
Cases per layer:			9
Layers/load:			3
Pattern:		2x2x3	Interlock
Max UL High:			4
Clamp Direction:			N/A

Notes: Master carton must be a sturdy, reshippable, double walled corrugate. Master carton must be able to pass a 200 lbs/in<sup>2</sup> bursting test or a 32 lbs per inch edge crush test. All measurements are approximate.



## Section – 5b (Wholesale)

### Quality Control guidelines

In addition to our TOPS Program, Quality Control is of paramount importance.

The following are Quality Control guidelines all Vendors must adhere to. **Failures to adhere to these guidelines whether in-transit or at PCHI Distribution Centers will result in chargebacks (see section 10 Reimbursement and Waiver Policy).**

### Labeling Requirements

- Labeling is checked on the master, inner, and eaches.
- Julian Date Coding is required on the master carton, inner pack and eaches.
- Labeling for master carton, inner pack and eaches must all have a scannable bar code.
- Each label has its own set of specifications. Refer to the separate sections for label requirements.
- Import Vendors also need to reference Section 7 for additional carton marking requirements

### UPC/Bar Code Requirements

- UPC's are checked for scannability and for the correct readable digits printed below the bar (human readable).
- Bar Codes are scanned for correctness. All bar codes must scan and verify against ANSI standards with a grade of "C" or better.
- It is the vendor's responsibility to ensure correct scannability of all bar coding.
- For the master carton label bar code, the minimum bar code height is 1.5". The bar code must be printed on the label to allow at least ½" white zone around the entire perimeter of the bar code.

### Packaging

- Packaging is checked to make sure that inners per master, eaches per inner, and eaches per master are correct according to Amscan's specifications.
- Packaging is checked to make sure correct packaging is used for each product if required (example: bubble wrap, corrugated inserts, special packaging if required / necessary).
- If polybags are to be used for inners, they must be a minimum of a 3 mil polyethylene bag and it must be securely sealed shut so the product cannot fall out.
- No strapping to be used on master cartons (do not strap 2 master cartons together).
- No staples to be used on master cartons or on inner cartons.
- No sub masters are ever to be used (unless pre-approved by the warehouse).
- If the inner is a display carton, securely tape the display carton closed on three sides.
- Inner cartons must be securely taped closed.
- Cartons are not to be cut down without approval from the warehouse.
- Any additional packaging material used to protect the product must be inside of the inner cartons. It cannot be surrounding the inner cartons in the master cartons.
- Costumes that are 1 each per inner do not need an inner polybag or an inner label. They just need a master label and each label. Exceptions to this are for items that need a carton inner for protection. They would still need the inner carton with an inner label. Also, items that are full case (1 Each per Master) would need the master label and a master carton.



## Section – 5b (Wholesale)

### Quality/Artwork

- Product is checked against the approved sample by the Product Manager or catalog copy.
- Item packaging is checked for new artwork and color schemes.
- Any quality defects are the responsibility of the maker. Chargebacks will be issued for any product which requires re-working or replacement.
- **PCHI Specification:** Requirements for packing and packaging are designed to ensure that all products arrive in sellable condition. PCHI's Packaging Specification, depending upon product category, is available on the PCHI Vendor Portal and addresses measures needed to minimize mold, mildew, spoilage, leakage, breakage, crushing, displacement, wrinkling, and other potential defects that may arise from transportation and/or packing of products which makes the product not sellable.

### Dimensions & Weight

- Measurements and weights are checked by the Cubiscan team and must meet all Amscan and TOPS requirements.
- No master carton should exceed the weight of 40 lbs. You must have approval from warehouse management prior to shipment being made if the weight of the master carton exceeds 40lbs.
- **MINIMUM MASTER CARTON SIZE:** 12" Length x 12" Width x 12" Height (prior approval is needed for any master carton deviating from the minimum carton size)
- **MAXIMUM MASTER CARTON SIZE:** 20" Length x 17" Width x 16" Height (prior approval is needed for any master carton deviating from the maximum carton size)
- Contact the TOPS Engineer for approval for dimensions and weights that deviate from these requirements.
- Final weights and dimensions of master cartons must be supplied to Amscan no later than 2 weeks prior to shipment.
- For items where the number of pieces in the inner is equal to the number of pieces in the master (full case items), the dimension requirements do not apply.

### Master Carton

- Carton should always be made of durable, double-walled, **C-Flute recycled** corrugate.
- Masters weighing up to 20 lbs, the minimum requirements are a 200 lbs per square inch (14.1 kg per square cm) bursting test or a 32 lbs per inch (5.7 kg per cm width) edge crush test.
- Masters weighing over 20 lbs, the minimum requirements are a 200 lbs per square inch (14.1kg per square cm) bursting test or a 48 lbs per inch (8.6 kg per cm width) edge crush test.
- You may not mix SKUs in a Master.
- **MASTER CARTON PACKS:** We will not accept 2 inners per master. These items should either be changed to 3 or more inners per master or the inner should equal the master depending on the size of the item.
- There should be no excess space in the master carton when the cartons are packed.

## Section – 5b (Wholesale)

	General Items based on ISTA 1A	
Carton Dropped	Drop minimum 1 Carton per style	
Drop height	Actual G.W. (kg)	Drop Height (cm)
	Up to <9.5kg	76.2 cm
	9.5 up to <18.6kg	61 cm
	18.6 up to <27.7 kg	45.7 cm
	27.7 up to <45.3kg	30.5 cm
	>= 45.3kg	20 cm
Drop face(s)	1 corner, 3 edges, 6 faces	
Check quantity after drop	all units in dropped carton	
Drop Sequence	<ol style="list-style-type: none"> <li>1. The most fragile corner.</li> <li>2. The shortest edge radiating from that corner.</li> <li>3. The next longest edge radiating from that corner.</li> <li>4. The longest radiating from that corner.</li> <li>5. Flat on one of the smallest faces.</li> <li>6. Flat on the opposite small face.</li> <li>7. Flat on one of the medium faces.</li> <li>8. Flat on the opposite medium face.</li> <li>9. Flat on one of the largest faces.</li> <li>10. Flat on the opposite large face</li> </ol>	
Defect Allowed	<p>a) The drop test result "FAIL" if any of the following is found</p> <p>For Carton:</p> <ol style="list-style-type: none"> <li>1. Product comes out from the carton.</li> <li>2. Any potential hazard existing on the carton (such as a sharp edge on the buckle of the banding strap).</li> </ol> <p>For Product:</p> <ol style="list-style-type: none"> <li>1. Any safety issue of the product.</li> <li>2. Any damage on the product.</li> <li>3. Any break or damage which influences the functionality of the product.</li> <li>4. Any components of hardware loosened and/or dislocated within the shipping carton.</li> </ol> <p>b) "Pending" for the master carton has serious crush or open seam or crush is found on the inner salable carton.</p> <p>c) "Pass with remark" for:</p> <ol style="list-style-type: none"> <li>1. Minor deformation of the corner of the carton or retail package;</li> <li>2. Any Minor defect on the retail package</li> </ol>	

### Drop Test Requirement

	Fragile & Brittle items (Glass, Ceramic, Polyresin; Polystyrene cups)	
	PCHI Special Requirements	
Carton Dropped	Drop 1 Carton per style	
Drop height	Ceramic, Polyresin, Polystyrene Cups items	45cm
	Glass items	30cm
Drop face(s)	1 side (Bottom side)	
Check quantity after drop	all units in dropped carton	
Drop Sequence	1. Bottom side	
Defect Allowed	Found breakage more than 0 percent - REJECT. (that means no breakage is allowed in the dropped carton)	

## Section – 5b (Wholesale)

	Chalk
	PCHI Special Requirements
Carton Dropped	Drop 1 Carton per style Drop one more carton if defects exceeds 25%
Drop height	a. G.W. <= 25kg, drop height = 60cm b. G.W. is between 25 ~ 30kg, drop height = 45cm c. G.W. >30kg, not needed to perform Carton Drop Test.
Drop face(s)	6 sides
Check quantity after drop	all units in dropped carton
Drop Sequence	1. Smallest face of carton. 2. Opposite side to the 1st dropped face. 3. Second large face near of carton. 4. Opposite side to the 3rd dropped face. 5. Largest face of the carton. 6. Opposite face to the 5th dropped face.
Defect Allowed	a. If there is 25% or less breakage after drop, the results should be rates as PASS, and DOES NOT need to drop the 2nd carton  b. Otherwise, drop one more carton if more than 25% breakage on first carton drop  c. If total breakage of both drops is 25% or less, the results should be rated as PASS, otherwise rate as FAIL  d. Example: Say there is total 200pieces chalks per 1 master carton 1. 1st Carton (250 pcs chalks) 2. 2nd Carton (250 pcs chalks) ii. Total Breakage of both drops: 1. If 100 chalks or less = PASS 2. If more than 100 chalks = FAIL

	Special Items* (* incl. Polystyrene PS Cutlery, Bubble Bottle)
	PCHI Special Requirements
Carton Dropped	Drop minimum 1 Carton per style
Drop Height	a. G.W. <= 25kg, drop height = 60cm b. G.W. >25kg, drop height = 45cm
Drop face(s)	6 sides
Check quantity after drop	all units in dropped carton
Drop Sequence	1. Smallest face of carton. 2. Opposite side to the 1st dropped face. 3. Second large face near of carton. 4. Opposite side to the 3rd dropped face. 5. Largest face of the carton. 6. Opposite face to the 5th dropped face.
Defect Allowed	a) The drop test result "FAIL" if any of the following is found For Carton: 1. Product comes out from the carton. 2. Any potential hazard existing on the carton (such as a sharp edge on the buckle of the banding strap. For Product: 1. Any safety issue of the product. 2. Any damage on the product. 3. Any break or damage which influences the functionality of the product. 4. Any components of hardware loosened and/or dislocated within the shipping carton. b) "Pending" for the master carton has serious crush or open seam or crush is found on the inner salable carton. c) "Pass with remark" for: 1. Minor deformation of the carton or retail package; 2. Any Minor defect on the retail package.



## Section – 5b (Wholesale)

### **CONEG/TPCH: Packaging Requirement**

Manufacturers and suppliers of packaging and packaging components are required by law to furnish a certificate of compliance to customers upon request (refer to the introduction section). This applies only to companies who actually put their products in the package and does not apply to the retailer or the individual consumer. The public and state also have access to these certificates.

In February 2021, the U.S. Toxics in Packaging Clearinghouse (TPCH), updated their model legislation to include a registration for the sum of all ortho-phthalates to no more than 100 ppm. The update also includes a restriction for all PFAS chemicals, defined as the class of fluorinated organic chemicals containing at least one fully fluorinated carbon atom to no detectable amount. This is in addition to the previous TPCH Model Legislation and laws enacted in 19 states that prohibit the intentional use of cadmium, lead, mercury and hexavalent chromium in any finished package or packaging component. The laws also limit the total incidental concentration of the four metals to 100 ppm.

Should there be any problems after cartons are received, or there is non-compliance with the above criteria, a redesign will be done to comply. Watch this very carefully so that this process and potential chargebacks can be avoided. Failure to meet the Quality Control guidelines will result in penalties as listed in Section 10 (Reimbursement And Waiver Policy) and Section 2 (Terms and Conditions).

### **Traceability**

**Children’s products will need permanent distinguishing marks on the product, to the extent practicable, to identify the manufacturer, location, date of production and other necessary information for all goods manufactured on or after 8/14/09.**

### **Amscan Labels**

#### **Master Carton Labels**

Amscan uses a sophisticated warehouse management system. The labeling of all master cartons according to the following guidelines will assist in maintaining accurate inventory levels at our distribution centers and will make it easier to service our customers. All efforts to meet these specifications must be made. Any questions regarding this should be handled with Kim Aldrich at email [koshea@amscan.com](mailto:koshea@amscan.com).

#### **Master Carton Label Guidelines**

- White labels with Black print are to be used unless specifically directed otherwise.
- For any liquid, a black printed arrow must be printed on the Master Carton with the wording “this side up”. The items should not be laid or packed sideways to avoid damage.
- Bar Code is interleaved 2 of 5, 14 digits or standard subset, 6 symbology.
  - Width of the narrow bar and space between bars to be a minimum of .015” (or 15mil).
  - The width of the wide bar and space must be twice as large as the narrow bar and space.
  - Minimum bar code height is 1.5”.
  - The bar code must be printed on the label to allow at least 1/2” white zone around the entire perimeter of the bar code.
- Bar Codes must be scannable.
- Label Size: 6” x 4” minimum; 6” x 6” maximum. (If label size is larger than the master carton, smaller labels may be used upon approval.)
- Use 2 labels per carton on adjacent sides
- Do not place label over sealing tape where box flaps join.
- Labels MUST be in type, NO handwritten labels
- Do not print the information directly onto the carton. A label must be used.

## Section – 5b (Wholesale)

- The font used must be a minimum of 14 pt font for everything except the Amscan locations, which must be at least 9 pt font and the country of origin which must be at least 10 pt font.
- The following information must be on all Master Carton labels:
  - Amscan Item Number
  - Unit of Measure Conversion: (This information must match the quantities listed on the Amscan purchase order)
    - EA/IP = Eaches per Inner pack (retail units per selling unit)
    - IP/MC = Inner pack per Master Carton (selling units per purchasing unit)
    - Total number of eaches in the Master Carton
  - Amscan Item Description
  - Amscan Purchase Order Number
  - Your Amscan Vendor Number
  - Country of Origin
  - The 2 digit country of origin barcode using symbology code 128
  - Human readable text of the Bar Code printed directly underneath bars
  - Gross weight of the carton (on the label or the carton itself)
  - Amscan name and locations
    - Amscan Inc.
      - Elmsford, NY 10523 USA
      - Toronto, ON, Canada M3J 2E8
  - The 14 digit interleaved 2 of 5 Bar Code with the horizontal lines all printed.
  - If item contains PEACOCK, OSTRICH and/or PHEASANT feathers, the label also must read "WILDLIFE" in upper right corner
  - Human readable digits of the Bar Code printed directly underneath bars
  - Production code printed below the Bar Code – (Julian Date Code) Example - February 21, 2013 to read as follows 13052.

### Master Carton Label Placement

The location of the Interleaved 2 of 5 (SCC 14) Bar Code on each side is as follows:

- Bottom of the bars must be 1.25" (+/-0.25") from the bottom of the carton.
- The clear areas on the sides of the bar code must be at least 0.75" from both edges of the carton.
- Interleaved 2 of 5 (SCC-14)
- See diagrams below for label placement

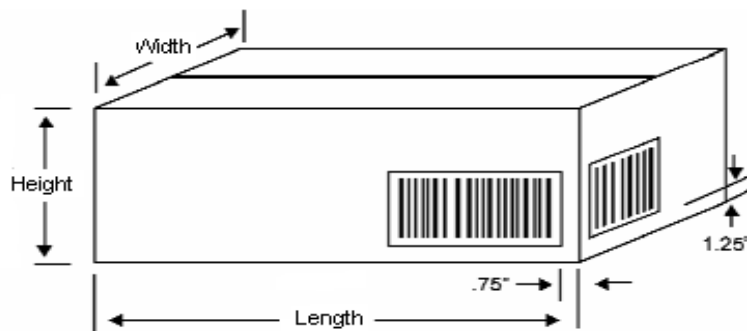





Section – 5b (Wholesale)

Master Carton Label Example

**670585**  
 12 EA X 8 IP = 96 EA/MC  
 DEC SWIRL VALUE BDAY FEVER  
 PO# 123456 VENDOR # 505  
 AMSCAN Inc. Elmsford NY 10523 USA  
 Toronto, ON, Canada M3J 2E8  
 England Milton Keynes MK10 0DA



CN  
MADE IN CHINA

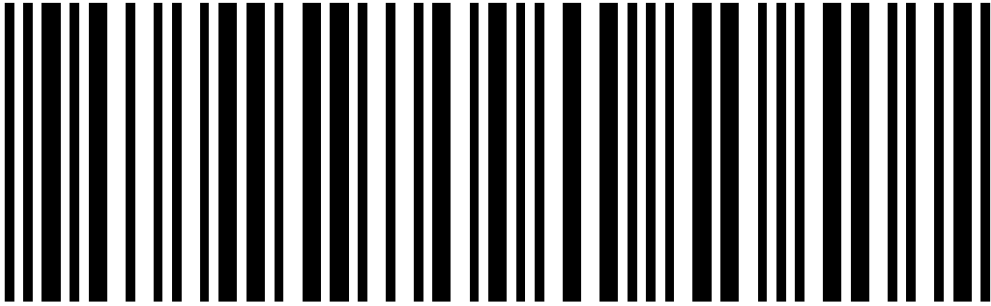

50013051313239  
 18052  
 GW: 12.34 KG

**\* 500-Series bar code denotes this carton is a Master.**

When the number of pieces in an inner carton equals the number of pieces in the master carton or the distribution will be done only by the complete Master Carton, the barcode should be the 300 series with all master carton information as shown on the example below.

**Section – 5b (Wholesale)**

**469042**  
 16 EA X 1 IP = 16 EA/MC  
 DEC LANTERN GID FIREFLY ITGXII  
**PO# 173793**    **VENDOR # 837**  
**AMSCAN Inc.**    Elmsford NY 10523 USA  
                                  Toronto, ON, Canada M3J 2E8  
                                  England Milton Keynes MK10 0DA



CN  
MADE IN CHINA



**GW: 12.34 KG**    30013051306848  
**13052**

The master carton label for a Kit is shown in the example below. The unit of measure should include KIT instead of EA. A KIT is several different each UPCs under one item number.

**858504**  
 1 KIT X 4 IP = 4 KIT/MC  
 SCENTOS FUNNY FACES MARKER  
**PO# 178998**    **VENDOR # 13270**  
**AMSCAN Inc.**    Elmsford NY 10523 USA  
                                  Toronto, ON, Canada M3J 2E8  
                                  England Milton Keynes MK10 0DA



CN  
MADE IN CHINA



**GW: 12.34KG**    50846376071108  
**13052**

**\* 500-Series bar code denotes this carton is a Master. Kits can also have 1 IP/MC and have a 300-series bar code on the master label.**

## Inner Carton Labels

### Inner Carton Label Guidelines

- White labels with Black print are to be used unless specifically directed otherwise
- Bar Code must be scannable
- Label Size: 4 5/8" Wide x 3 1/2" High (If label size is larger than the inner carton, smaller labels may be used upon approval.)
- Place label on the inner carton so that the inner label is showing when the master carton is opened. If the side that is facing out when the master carton is opened is too small to fit the label, the largest size may be used.
- The following information must appear on the label:
  - Amscan Item Number
  - Number of packages in the inner
  - Amscan product description
  - Amscan Purchase Order Number
  - Country of Origin
  - The 2 digit country of origin barcode using symbology code 128
  - Human readable text of the Bar Code printed directly underneath bars
  - Your Amscan Vendor Number
  - Amscan name and locations:
    - Amscan Inc.
      - Elmsford, NY 10523 USA
      - Toronto, ON, Canada M3J 2E8
      - England, Milton, Keynes MK10 0DA
  - Bar Code, interleaved 2 of 5, 14 digits
  - Human readable digits of the Bar Code printed directly underneath bars
  - Production code printed below the Bar Code – (Julian Date Code) February 21, 2013 to read as follows 13052.

### Inner Carton Label Placement

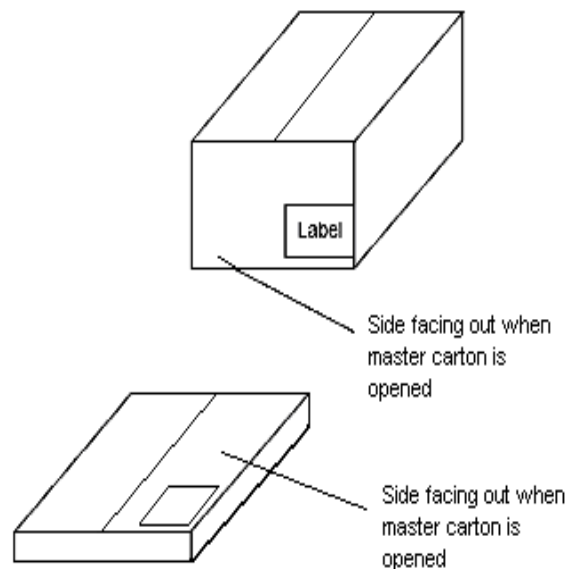

**Inner Carton Label Example**

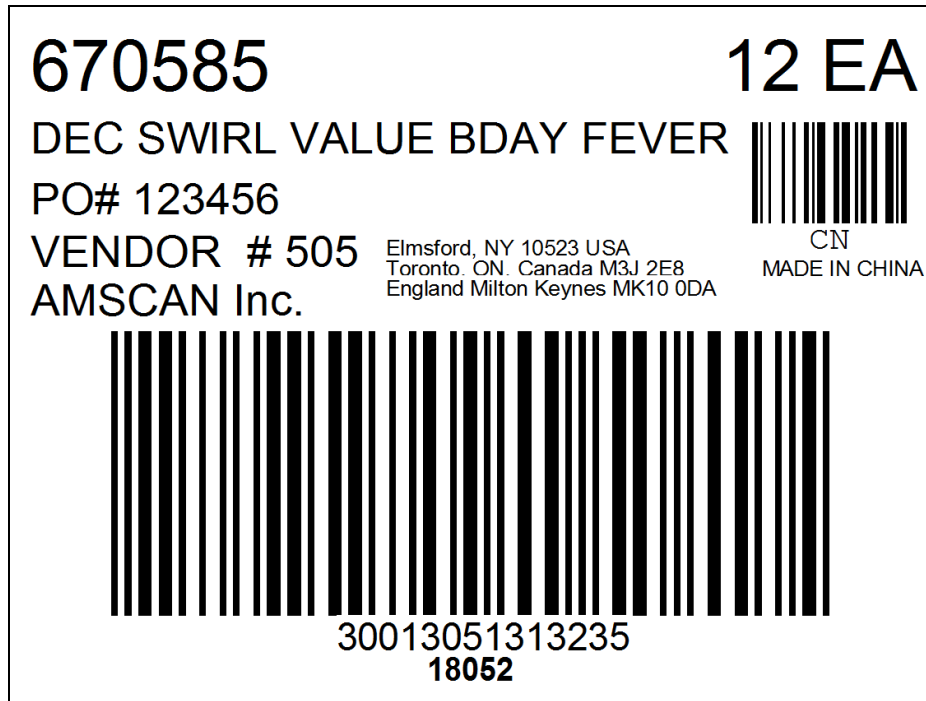

\* **300 – Series bar code denotes this carton is an Inner.**

**Eaches Labels**

The correct printing of clear UPCs is of primary importance due to market sensitivity. If an incorrect UPC is printed, or the UPC is un-scannable, there will be a chargeback without warning due to the ramifications of the error.

All barcodes appearing on the label printed for Amscan’s use shall meet the specifications contained herein.

In most cases, Amscan provides the UPC artwork (included with each packaging artwork) to our vendors. Whether or not Amscan supplies eaches label artwork, the vendor should pay specific attention to the following guidelines.

**Eaches Label Guidelines**

- White labels are to be used unless specifically directed otherwise
- Print in black
- All UPC's should be in standard UPC-A format and scan at the grade level of "C" or better
- Barcode must be scannable
- Label size needs to be an appropriate size for the item (no overhang)
- One label is to be used unless the item/each come in a box, container, or display. In this case the box, container, or display AND the piece must each have the label.
- The following information needs to be on the labels
  - Amscan item #
  - Your Amscan Vendor Number
  - Country of origin
  - UPC/barcode

## Section – 5b (Wholesale)

- Human readable version of the bar field must appear directly below the barcode
- Amscan name and locations (if applicable)
- Production code printed below or to the side the Bar Code – (Julian Date Code)
- Example – June 1, 2009 to read as follows 09152.

### Eaches Label Examples

#### **EXAMPLE OF AMSCAN ITEM UPC LABEL**

Sample UPC has been enlarged for viewing

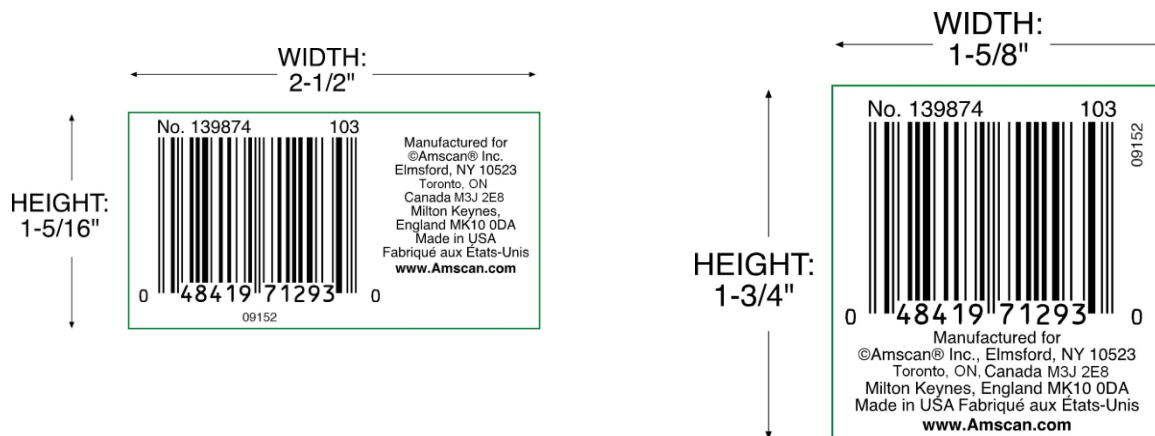

### PACKAGING/LABELING FOR CANDY PRODUCTS

#### DATE CODE REQUIREMENT

For all candy products, we have instituted a specific date code requirement to identify the production date of the candy. This 10 digit identification number is referred to as the Lot Number.

The Lot Number consists of the calendar date of production placed between 2 pairs of numbers as follows:

Position #s start from left to right

- Positions 9 & 10: will list as 99 and will not change
- Positions 7 & 8: represents the month
- Positions 5 & 6: represents the day
- Positions 3 & 4: represents the last 2 days of the year
- Positions 1 & 2: will list as 00 (a constant number for now – however, this could potentially change if needed in the future)

An example of the Lot Number with the calendar date of January 1, 2008 would be listed as:

**9901010800**

An example of the Lot Number with the calendar date of April 25, 2008 would be listed as:

**9904250800**

## Section – 5b (Wholesale)

### Master Carton Lot Number

The Lot Number must be printed directly onto the Master Carton as large as possible. It must be printed on the top right hand corner on each side of the Master Carton. Please refer to the following example.

i.e. LOT # 9901010800



### Inner Carton Lot Number

The Lot Number must be printed on the inner carton label as large as possible underneath the inner UPC code. Please refer to the following example.

i.e. LOT # 9901010800



## Section – 5b (Wholesale)

### Package Lot Number

The lot Number must be printed directly onto the package at the lower right corner of the package as legible as possible. Please refer to the following example.

i.e. 9912010700

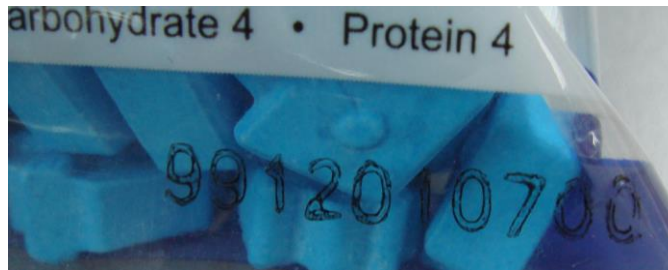

### Manual calculation of the check digit for Amscan labels

#### Symbology for Inner and Master Label

Both use the Interleaved 2 of 5 (I 2/5) symbology with 14 digits of numeric data. The data looks like this:

13	12	11	10	9	8	7	6	5	4	3	2	1	CH
----	----	----	----	---	---	---	---	---	---	---	---	---	----

where

digit #	definition
13	for the Inner, it is typically a 3; for the Master, it is typically a 5
12	always a zero
11 – 1	left most 11 digits from the UPC #
CH	check the digit calculated based on the other 13 digits

Calculation of the check digit:

1. Sum of the digits in the ODD positions and multiply the result by 3
2. Sum the digits in the EVEN positions and add to the above result
3. Find the digit to add to the result of 2. Above so that the new number ends in zero. That digit is the checksum digit.

Example: 43030.01 7" PLSTC PLATE 20 CT-REGL BLUE UPC 012795107581

Inner Box Bar Code

3 0 0 1 2 7 9 5 1 0 7 5 8

1.  $3 + 0 + 2 + 9 + 1 + 7 + 8 = 30$

$30 * 3 = 90$

2.  $0 + 1 + 7 + 5 + 0 + 5 = 18$

3.  $90 + 18 = 108$

$108 + CH = 110; CH = 110 - 108 = 2$

Therefore, the Inner Box Bar Code is: 30012795107582



## Section – 5b (Wholesale)

Master Box Bar Code

5 0 0 1 2 7 9 5 1 0 7 5 8

1.  $5 + 0 + 2 + 9 + 1 + 7 + 8 = 32$   
 $32 * 3 = 96$
2.  $0 + 1 + 7 + 5 + 0 + 5 = 18$
3.  $96 + 18 = 114$   
 $114 + CH = 120; CH = 120 - 114 = 6$

Therefore, the Master Carton Box Bar Code is: 50012795107586





## Section – 6a,c (Retail)

### Product Safety and Quality Assurance

#### Overview – Party City (includes Party City, Party America, and Halloween City)

Vendors shipping product directly to any retail entity of PCHI (The Company), including Party City, Party America, **Party City web warehouse** and Halloween City locations, shall be required to have previously tested their products to meet all applicable local, state and federal regulations at the time of sale. All test results shall be made available upon request and sent to [pcps.testreports@amscan.com](mailto:pcps.testreports@amscan.com) before shipment. It is expected that all vendors will have testing information within the past calendar year or season, as applicable, on file for their product and be compliant with respect to the terms and conditions outlined in the Vendor Standards Manual (Section 2). In the event testing results are not available, the retail entity will require that your product be sent to a third party, independent testing laboratory which is approved by the Consumer Product Safety Commission to test products in accordance with the Consumer Product Safety Improvement Act of 2008 (CPSIA), for testing at your expense. This applies to all items that are shipped to US stores and that do not bear the Amscan brand and/or Amscan USA address, regardless of whether or not the item is shipped directly to PCHI retail stores by the vendor or is distributed by Amscan.

The Consumer Product Safety Improvement Act of 2008 and the Consumer Product Safety Acknowledgement is also on the Party City Vendor Website and needs to be signed and returned.

#### Certification and Testing Documentation

Vendors must certify based on a test of each product they supply The Company's retail outlets or upon a reasonable testing program that all product The Company's retail outlets purchases complies with all rules, bans, standards, or regulations applicable to that product under the Consumer Product Safety Act of 2008, any other Act enforced by the Consumer Product Safety Commission (CPSC), and all U.S. FDA Codes of Federal Regulations (CFR). Upon request by The Company's retail outlets, vendors must supply to The Company's retail outlets via email at [pcps.testreports@amscan.com](mailto:pcps.testreports@amscan.com) all certification and testing documentation, including GCC's/CPC's for any products they supply The Company's retail outlets within two business days.

In accordance with the new laws put forth by the Consumer Product Safety Improvement act of 2008 (CPSIA) a General Certificate of Compliance (GCC) or Children's Product Certificate (CPC) will need to be provided with shipments of toys and children's items, and some other applicable products such as general purpose lighters, wearing apparel, and art materials. You need to submit the GCC or CPC with the shipping documents for items imported into the country and also send via email a copy (for all applicable items) to the Amscan database at the email addresses listed at the bottom of the GCC document enclosed at the end of this Section **6a,c**.

**The GCC or CPC needs to be included with every shipment into the United States and every applicable item needs to have at least one GCC or CPC on file.**

## CPSIA and Safety Requirement Guidelines

The Consumer Product Safety Improvement Act of 2008 (CPSIA) changed the safety requirements of many items sold by The Company's retail outlets. As part of The Company's commitment to fully comply with CPSIA, it is mandatory that products supplied to The Company's retail entities by its vendors covered under the Consumer Product Safety Improvement Act of 2008 (the Act) be in compliance with all requirements of this legislation. This includes, but is not limited to, the following areas of the Act:

- Children's products containing lead and the lead paint rule. (Title I – Section 101 of the Act)
- Mandatory third party testing for certain children's products and certification requirements. (Title I – Section 102 of the Act)
- Tracking labels for children's products. (Title I – Section 103 of the Act). A children's product must contain a permanent, distinguishing mark on the product and its packaging, to the extent practical, that will enable the manufacturer and ultimate purchaser to ascertain the manufacturer, location and date of production of the product, and cohort information including: Item# - Vendor# - Year Made – Country of Origin. This information shall be included on each individual children's product manufactured on or after August 14, 2009, as practicable, Traceability information shall use a minimum font size of 1/32 inches based on lower case "h" as a guide to help determine if applying traceability information in accordance with Title I – Section 103 of the Act is practicable.
- Labeling requirements for children's toys and games, and the vendors obligation to provide the necessary cautionary statement information required by the Act. (Title I – Section 105 of the Act)
- Mandatory toy safety standards. (Title I – Section 106 of the Act)
- Prohibition on sale of certain products containing specified phthalates. (Title I – Section 108 of the Act)

### Food, Cosmetics, and Products that come into contact with Food

Vendors that supply PCHI with cosmetics, food, and products that come into contact with food are required to comply with all U.S. FDA (Food and Drug Administration) regulations, including the Food Safety Modernization Act (FSMA), U.S. FDA CFR Title 21, including but not limited to Part 117, and Proposition 65 regulations. For those facilities that produce food and cosmetics, the following documentation, with satisfactory result(s) is required, but not limited to: i) factory contact & address, ii) applicable GMP food facility certification audit, or equivalent, iii) product test report(s) in accordance with applicable test protocols, iv) packaging claims and independent, third party substantiation, v) certificate(s) of insurance, vi) product and process inspection plan in accordance with FDA or equivalent methodology, vii) current social compliance audit per PCHI Code of Conduct requirements, viii) current FDA bioterrorism registration certificate, and ix) applicable country certification(s) required by local or national law.

**Effective January 1, 2021, all food packaging must be free of any intentionally added Per- and polyfluoroalkyl substance (PFAS) chemicals.** Please refer to the letter, PFAS letter for Food Packaging Items on the Party City Vendor Enablement Site for more information.

All cosmetic items are expected to comply with California Proposition 65 & the future California Toxics in Cosmetics law AB 2762, effective January 1, 2025, which bans intentionally added ingredients of 24 specified chemicals, including PFAS chemicals. Please refer to the letter Adherence to California Proposition 65 & Future California Toxics in Cosmetics law AB 2762 on the Party City Vendor Enablement Site for more information.

### Glassware

Vendors that supply The Company's retail outlets with printed or painted glassware products are required to comply with all U.S. FDA regulations, including U.S. FDA CFR Title 21, and Proposition 65 regulations.

**Section – 6a,c (Retail)**Electrical and Electronic Products

All electrical items must have a valid NRTL listing (ETL/UL/CSA, etc...) for plug-in electrical safety, and be listed for electrical safety in both Canada and United States. All battery operated children's products shall meet battery safety and low voltage requirements for toys as outlined in ASTM F963. For battery operated products where a US safety test is not available, product shall meet reasonable safety standards. For example, products with electronic wire in close proximity to face, head or body, vendor must provide IEC 60335-1:2010+A1:2013+A2:2016 test for safety verification. Refer to the PCHI Product Testing Protocol Summary located in the Reference Documents tab on the Amscan vendor portal.

Effective on February 28<sup>th</sup>, 2022, any Seasonal and decorative lighting products with nominal 120-volt input voltage rating that contains an electrical cord casing in which lead is present in a quantity greater than 100 ppm, the following warning label shall be attached for sale to New York:

**"WARNING: HANDLING THE COATED ELECTRICAL WIRE OF THIS PRODUCT MAY EXPOSE YOU TO LEAD. WASH HANDS AFTER USE.**

Certification and Testing Documentation

Vendors must certify based on a test of each product they supply The Company's retail outlets or upon a reasonable testing program that all product The Company's retail outlets purchases complies with all rules, bans, standards, or regulations applicable to that product under the Consumer Product Safety Act of 2008, any other Act enforced by the Consumer Product Safety Commission (CPSC), and all U.S. FDA Codes of Federal Regulations (CFR). Upon request by The Company's retail outlets, vendors must supply to The Company's retail outlets via fax at 973-983-4736 all certification and testing documentation for any products they supply The Company's retail outlets within two business days.

Cautionary Statements

As detailed in Section 105 of the Act, vendors are required to inform The Company's retail outlets of all internet and printed material advertisement cautionary statement requirements for product they supply The Company's retail outlets. Under the Act, vendors not only are required to inform The Company's retail outlets of the any product requiring a cautionary statement, vendors must also inform The Company's retail outlets of the cautionary statement details necessary to be in compliance with the Act. If revisions to this Act, other CPSC Acts, U.S. FDA CFR's, or future consumer safety legislation or regulation results in additional or alternate safety requirements, our vendors are required to meet those standards. This includes, but is not limited to, requirements specified in our Vendor Standards Manual and state regulations of Proposition 65, CONEG Toxics in Packaging regulations, Washington State Chemicals of High Concern to Children (CHCC), Maine Toxic Chemicals in Children's Products, Oregon's High Priority Chemicals of Concern for Children's Health, or any other applicable laws.

**State Chemicals in Children's Products**

There are certain chemicals which have notification and/or regulatory requirements for the states of Maine, Oregon, Vermont, New York and/or Washington in the United States. If your product(s) contain chemicals from the PCHI Chemical List (last updated on 8/27/2021, made available on Party City's Vendor [Enablement Site](#), and updated from time to time) that are unintentionally added to children's products above the Practical Quantitation Limit (PQL), which, for practicable purposes, is 100 ppm (0.01%), please inform PCHI of the chemical name and amount by weight of the chemical in the product. [Please note that the PQL is based on the test methodology used for chemical detection]. If you have testing done to levels below 100 ppm for any chemicals on the PCHI Chemical List that are intentionally added, then please inform us of the level to which the chemicals are being measured and the level of the chemical.

Some chemicals with a check mark on the PCHI Chemical list for SVHC also have a check mark for Maine, Oregon, Vermont, New York and/or Washington State. These chemicals, if present, need a corrective plan to find a suitable replacement. Note that Lead (Pb), Cadmium (Cd), Arsenic (As), Antimony (Sb), Mercury (Hg), Bisphenol A (BPA), Formaldehyde, and Phthalates DBP, DEHP(DOP), BBP, DINP, DNOP, DIDP, DIOP, DIBP, DPP(DPENP), DNHP(DHEXP), DCHP, DEP, and MBP (CAS#131-70-4) do not require

**Section – 6a,c (Retail)**

notification since a control program as stated in this Vendor Standards Manual (“VSM”) and PCHI’s Guidelines for Children’s and Other Products is in place to ensure that the products you supply to PCHI and its affiliated companies comply with applicable local, state, and federal regulations for these chemicals. For example, Lead in surface coating and substrate needs to be under 40 or 90 ppm, depending upon product category, and under 1 microgram using the NIOSH 9100 test according to California Proposition 65 regulations, Phthalates need to be under 1000 ppm (0.1%), and total Cadmium needs to be under 75 ppm.

All non-child items are expected to comply to all California Proposition 65 requirements by evidence of 3<sup>rd</sup> party testing or visual confirmation of a legal Prop 65 warning on the products packaging. If product contains a Prop 65 warning, please provide the PC compliance team with a photo of a warning language ([pcps.retailreports@amscan.com](mailto:pcps.retailreports@amscan.com)). Note: No Halloween theme products may contain a Prop 65 warning. For further questions on Prop 65 requirements and labeling please refer to: <https://oehha.ca.gov/proposition-65/>

**CFR****1107**

As part of US federal regulation 16 CFR 1107 requirements effective February 8, 2013 for children's items, PCHI needs to ensure that all items comply with applicable regulations.

In addition to the current periodic production testing, GCC or CPC, and random sampling that PCHI is already doing with your cooperation, please ensure the following:

1. You inform PCHI of any significant changes in materials, factories, processes, designs, or construction for children's items that you manufacture for PCHI. A sample Product Change Notice (PCN) form is enclosed in 6b section for your use or reference.
2. Your company has on file, and viewed by all, a written policy statement from a company officer stating that the exercise of undue influence on third party conformity assessment bodies is not acceptable, a letter to all appropriate staff members to receive training on this policy, and a signed statement attesting to their participation in such training.

If there are any reports of alleged undue influence, please investigate immediately and inform PCHI as soon as possible. If you have any questions on the requirements of 16 CFR 1107 or your obligations to PCHI, please contact us immediately.



**HALLOWEEN CITY**



**Section – 6a,c (Retail)**

## **CPSIA and Safety Requirement Guidelines Acknowledgement**

To acknowledge your receipt of this VSM’s Product Safety and Quality Assurance requirements, please indicate which PCHI retail entity you are supplying, sign and date this document to certify that all products you supply to PCHI’s retail entity are in compliance, and will continue to be in compliance in the future, with the Consumer Product Safety Improvement Act of 2008, other Consumer Product Safety Commission Acts, and all applicable U.S. FDA or state regulations. Please return a copy of the signed and dated document to the fax number of the Product Safety retail entity representative. (All retail entity contacts are listed in Section 11 of this Vendor Standards Manual).

If you have any questions, please contact the respective representative of The Company’s retail entity anytime.

PCHI Retail Entity \_\_\_\_\_

Vendor Signature \_\_\_\_\_

Printed Name \_\_\_\_\_

Title \_\_\_\_\_

Company Name \_\_\_\_\_

Date of Signature \_\_\_\_\_

Please refer to *Party City, Party America, and Halloween City Guidelines for Children’s and Other Products* on the vendor website, [www.partycityvendors.com](http://www.partycityvendors.com) for a summary of specific product safety requirements (Vendor Compliance Guidelines - Retail PDF). A copy of this is in the Appendix.

**All vendors that ship direct to PCHI retail locations must complete and email or fax this acknowledgement form to [vendorrelations@partycity.com](mailto:vendorrelations@partycity.com) or fax to 973-983-4915.**

## CHILDREN'S PRODUCT CERTIFICATE / GENERAL CERTIFICATE OF CONFORMITY

CERTIFICATE DATE:

CERTIFIED BY:

MANUFACTURER NAME:

ADDRESS:

CITY:

STATE/PROVINCE:

COUNTRY:

PHONE#:

**Importer: (Name, Address & Phone #)**

Amscan Inc.  
80 Grasslands Road  
Elmsford, NY USA  
914-784-1910

**Importer: (Record Keeping Contact)**

VP - Product Safety  
80 Grasslands Road  
Elmsford, NY USA  
914-784-1910/minzalac@amscan.com

Item Number	Item Description	Vendor Number	Purchase Order #	Date of Manufacture (Month/Year)	Place of Manufacture (City & Country of Origin)	Testing Date (Month/Year)	Place of Testing/ Third Party Testing Lab (Name, Address & Phone #)

In accordance with Section 14 of the Consumer Product Safety Act, 15 U.S.C. 2063(a), the manufacturer certifies that based upon a test or a reasonable test program, the product listed above complies with all applicable consumer product safety rules, bans, regulations or standards under the Consumer Product Safety Improvement Act (CPSIA) of 2008 or any other Act enforceable by the United States Consumer Product Safety Commission, as indicated in Table 1 below (check all that apply). Also check all applicable FDA or Prop 65 regulations. Double click grey box and select "Checked"

Check All

That Apply

**Table 1: Consumer Product Safety Rules (Children's Products)**

- |                          |  |                       |
|--------------------------|--|-----------------------|
| <input type="checkbox"/> | Lead in Surface Coating (Children's Product) | 16 CFR 1303           |
| <input type="checkbox"/> | Lead in Substrate (Children's Product)       | CPSIA 101             |
| <input type="checkbox"/> | Lead in Children's Metal Jewelry             | CPSIA 101(a)(2)       |
| <input type="checkbox"/> | Choking Hazard Labeling (Children's Product) | 16 CFR 1500.19        |
| <input type="checkbox"/> | Pacifiers (Children's Product)               | 16 CFR 1511           |
| <input type="checkbox"/> | Rattles (Children's Product)                 | 16 CFR 1510           |
| <input type="checkbox"/> | Children's Products with Liquids             | 16 CFR 1500.14        |
| <input type="checkbox"/> | Toys (ASTM F963)                             | CPSIA 106             |
| <input type="checkbox"/> | Flammability of Solids (Children's Product)  | 16 CFR 1500.44        |
| <input type="checkbox"/> | Flammability of Textiles (Adult & Child)     | 16 CFR 1610           |
| <input type="checkbox"/> | Flammability of Plastic Film (Adult & Child) | 16 CFR 1611           |
| <input type="checkbox"/> | Phthalates in Toy & Childcare Items          | CPSIA 108             |
| <input type="checkbox"/> | Art Materials (LHAMA)                        | 16 CFR 1500.14(b) (8) |

**Table 2: OTHER TESTING**

- |                          |                                     |                          |                                |
|--------------------------|-------------------------------------|--------------------------|--------------------------------|
| <input type="checkbox"/> | TRA                                 | <input type="checkbox"/> | USP 61/62 and/or USP 51        |
| <input type="checkbox"/> | Formaldehyde testing (under 75 ppm) | <input type="checkbox"/> | FDA Ingredient/Labeling Review |
| <input type="checkbox"/> | Lead in Cosmetics                   | <input type="checkbox"/> | Mercury in Cosmetics           |
| <input type="checkbox"/> | FDA testing (specify FDA test #)    | <input type="checkbox"/> | California Prop 65 Phthalates  |
| <input type="checkbox"/> | California Prop 65 lead             |                          |                                |

**Item#\_Vendor#\_Certificate Date with MMDDYYYY (For example, item 123456 from vendor number 999 made on November 12, 2008 would be 123456\_999\_11122008.doc)** to the following distribution: [pcps.testreports@amscan.com](mailto:pcps.testreports@amscan.com).



## Section - 6b (Wholesale)

### Product Safety and Quality Assurance (PSQA)

#### A. INTRODUCTION & OVERVIEW

The global marketplace is demanding and the regulatory environment for consumer product safety is ever changing. PCHI is committed to taking a leadership position in providing innovative, fun and safe products to consumers all over the world and we expect that our suppliers share that commitment.

PCHI (Party City Holdings Inc), and affiliated companies, including, but not limited to Amscan, and Anagram International, is dedicated to ensuring that all of its products meet or exceed federal, state and municipal requirements. To this end, PCHI conducts rigorous testing of its products both internally and with government-approved testing organizations. Any product that fails to meet governmental or PCHI's standards will not be distributed.

As part of PCHI's continuous efforts to ensure the safety, quality and integrity of our products from production and shipment through retail sale and consumer use, PCHI wants to emphasize that we treasure all our vendors and suppliers whom we trust to manufacture and ship our products. PCHI relies upon our suppliers to support PCHI policies and needs your support and full cooperation on the following:

#### Raw Material Testing

It is difficult to overstate the importance of using safe and good quality materials in all the products, designs and components made for PCHI. If products start with safe and good quality materials, we can be assured that the finished products will be in compliance with regulations set forth for heavy metals and other chemicals such as phthalates, lead, cadmium, mercury, antimony, arsenic, barium, cadmium, chromium, and selenium. Accordingly, it is recommended that all vendors have testing results and certificates from all their suppliers showing that the raw materials used for PCHI products are safe and compliant for all of the markets where PCHI's products are sold. This should include, but not be limited to, lead and heavy metals in the inks, plastic resins, coatings, and paper stock.

#### Prototype Testing and Internal Design Evaluation

Some product categories are quite complicated, and it is prudent to evaluate certain products and resolve safety or quality issues before starting mass production. For example, children's items, jewelry, food contact products, apparel, cosmetics, candles, art materials, scene setters, and liquid containing items typically require unique and extensive evaluation. PCHI is aware that this may impact the production start and be an additional cost for vendors. As a result, we urge vendors to send prototype samples for testing as soon as they have been finalized and have the samples tested to protocols that PCHI specifies. To have as accurate a prototype as possible, PCHI highly recommends using materials that have been tested to be in compliance with applicable standards and PCHI is readily available to help its vendors in selecting the appropriate testing protocols for all products. PCHI also encourages vendors to cooperate early in the development cycle for packaging and labeling evaluation. The earlier vendors submit the sample(s) for evaluation, the earlier they will get useful information and keep production schedules. For certain products as those categories mentioned above, PCHI does not recommend starting mass production prior to prototype samples receiving a passing grade from a CPSC-approved, independent, third party testing laboratory. From time to time, PCHI will specify that prototype testing be done for a specific item. In those cases where prototype tests are initiated by PCHI, PCHI will pay for the reasonable testing fees unless otherwise indicated.



## Section - 6b (Wholesale)

### Production Sample Testing

Production sample testing is a true indicator of a finished product's safety or quality level. On specific products, shipments or receipts will not be authorized prior to production sample(s) receiving a passing grade by PCHI's designated third party testing laboratory. PCHI's purchase orders, and/or an email from the local PCHI office, will indicate which items need to be tested prior to shipment. It is critical that shipment of the specified products not occur without PCHI's confirmation to you of a pass testing result on the production samples or PCHI's agreement that the product can ship without a testing report. If shipment occurs without a passing test report or PCHI approval, vendors will have full responsibility for all liabilities incurred by PCHI as noted in the purchase order. In addition, once an item passes testing, no changes can be made to that product without PCHI approval and, in certain cases, another test. Changes include, but are not limited to, change of ink or paint, change of raw material, reduction of weight, new mold design, new subcontractor used or any other significant change in the product's design, construction, appearance, or materials. Depending upon factory location and other risk assessment factors, PCHI will either pick up the production sample(s), request vendors to deliver finished production sample(s) to the local PCHI office or arrange for sample delivery based on a mutually agreed process. Further, if the product fails testing and the test is proven to be valid, vendors shall be responsible for payment of the cost of tests which result in a failing designation, along with related expenses described in Sections 2 and 10 of this VSM and shall be further responsible for payment of any subsequent test on such item(s) until it receives a passing result for the failed issue(s).

### Environmental Packaging Regulations

In accordance with environmental regulations for 19 states in the USA, the packaging provided with PCHI products cannot contain an aggregate total of lead, cadmium, mercury and hexavalent chromium in excess of 100 ppm, **phthalates in excess of 1,000 ppm and PFAS at detectable levels**. This is known as the CONEG requirement (Coalition of Northeastern Governors) or **Toxics in Packaging Clearinghouse (TPCH)**. PCHI expects that all vendors are holding their suppliers to this requirement and PCHI will randomly test for compliance. If it is found that packaging (which includes the disposable parts of the master and inner) used for PCHI products is not in compliance, vendors will be responsible for providing complete remedy. PCHI recommends that vendors have test reports or certificates for all of the finished packaging materials which are used in PCHI products.

### Lead and Heavy Metal Testing Resource

PCHI has purchased x-ray devices which can detect lead and other heavy metals in certain products or raw materials. The x-ray devices in Hong Kong, China, and Vietnam are resources available to international vendors for evaluating prototype samples, raw materials or random production samples. X-ray devices located in New York are available to domestic vendors for evaluating pre-shipment samples. If vendors decide to purchase an x-ray device, PCHI is readily available to help them with proper use for PCHI products. Please note that the x-ray device is not a substitute for third party testing, where required.

Occasionally we will need to send suspect items out for laboratory testing. Please be advised that if the laboratory testing results indicate non-compliance with applicable federal or state standards, your company will be charged by PCHI for the cost of the testing. You could also be charged for inventory handling, disposal, legal settlement fees, and other associated expenses as indicated in our purchase orders and Section 2 of this VSM.

### Phthalate Testing Resource

PCHI has purchased test equipment which can detect the presence of phthalates and other chemicals in certain products and product components. The devices are located in New York, Hong Kong, China





## Section - 6b (Wholesale)

and Vietnam are available as a resource to vendors for evaluating prototype samples, raw materials, random production samples or other pre-commerce materials.

We are using the devices to randomly sample incoming, pre-commerce inventory for phthalates and other chemicals. Occasionally we will need to send suspect items out for laboratory testing. Please be advised that if the laboratory testing results indicate non-compliance with applicable federal or state standards, your company will be charged by PCHI for the cost of the testing. You could also be charged for inventory handling, disposal, legal settlement fees, and other associated expenses as indicated in our purchase orders and Sections 2 and 10 of this VSM.

### Traceability with Production Date Code

PCHI has added the need for production date code information for all merchandise shipments effective January 1, 2008. By now, vendors should have cleared their on hand materials and have started using date coding which is currently in the format of "Month-day-year". Going forward, PCHI will be implementing Julian calendar date coding and will phase this in to enable a smooth transition at the factory.

For example, the Julian date code for June 1, 2010 would be 10152, where the first two digits are the year and the next three digits are the day of the year. Please refer to the enclosed Julian calendar for future date coding.

The date code should be printed underneath the UPC bar code.

The date code needs to be visible on the product "each", inner and master carton labels.

There are additional traceability requirements for Children's Products as part of the Consumer Product Safety Improvement Act of 2008 (CPSIA) that are effective for applicable products manufactured after August 14, 2009. Wherever practicable, children's items and other applicable product categories shall contain traceability information that allows the consumer to identify or readily obtain information as to where, when, and by whom the item was manufactured. Please refer to [www.CPSC.gov](http://www.CPSC.gov), the enclosed PCHI Regulatory Guidelines, and supplemental instructions as available for the requirements.

### General Certificate of Compliance (GCC)

In accordance with the new laws put forth by the Consumer Product Safety Improvement act of 2008 (CPSIA) a General Certificate of Compliance (GCC) or Children's Product Certificate (CPC) will need to be provided with shipments of toys and children's items, and some other applicable products, that are manufactured after November 11, 2008.

For PCHI, the certificate applies mostly to children's products that are primarily intended for use by children 14 years of age and under, but there are some other product categories that fall under the jurisdiction of the Consumer Product Safety Commission, such as wearing apparel and art materials. PCHI will indicate on its purchase orders which specific items need the GCC/CPC. Please refer to the GCC/CPC template at the end of this section and if you are making a product for PCHI that is included in Table 1, then a GCC/CPC is needed.

The GCC/CPC is verification that an item has passed the required tests for the US market, which are currently done when you send production samples to PCHI's Hong Kong or USA office for test submission. On the applicable items, a PASS test report will need to have been received or verified, and the GCC/CPC completed, before shipping the item. You need to submit the GCC/CPC with the shipping documents and also send via email a copy to the PCHI database at the email addresses listed at the bottom of the GCC/CPC document enclosed.



## Section - 6b (Wholesale)

You can send the email certificate as soon as a "Pass" test report is either received or confirmed by the local PCHI office. It is important to have the certificate and pass test report confirmation before shipment since PCHI's brokers will not accept the booking without the proper GCC/CPC. PCHI can accept prior test reports as evidence of compliance as long as:

- 1) The materials, design, processes and factory are the same for the items sent to PCHI as the production sample(s) that were submitted for testing within the past year, and
- 2) The test report(s) contain all applicable tests. For example, toys were tested to the PCHI standards for phthalates, the most recent version of ASTM F 963, flammability, and lead in surface & substrate.

### Random Testing and Inspection

Periodically PCHI, or a third-party representative, will visit vendor factories to pull samples randomly from production lines and send samples for testing or conduct visual inspection to ensure the quality, compliance, and safety levels during production. PCHI also is randomly testing and inspecting finished goods in our US distribution center. In accordance with our purchase order terms and conditions and stated in section 2 of this Vendor Standards Manual, vendors could be held liable for all incurred expenses and costs for failed inspections and conducting re-inspection for corrected merchandise. Inspection standard shall be ANSI/ASQC Z1.4, or equivalent, typically with General Inspection Level II and 2.5% AQL, or as specified by customer requirements. Testing will be conducted on all applicable items from each purchase order received at our warehouse. Should an item be found to have lead, phthalate, and/or heavy metal levels above the acceptable limit, the entire quantity of the specified product from that purchase order will be destroyed or returned to the vendor for correction if possible. The vendor will be charged back the cost of the product, all costs associated with the shipment and delivery of the product to our warehouse, and the cost to safely destroy the product. The vendor will be required to send PCHI replacement product that meets all acceptable levels of lead and/or heavy metals. If the product is needed immediately and cannot be shipped via water, the vendor will be responsible for the air freight expense to expedite the delivery of the product. Please refer to our purchase order notes and Section 2 of this VSM for further clarification.

Note: PCHI reserves the right to require re-testing and/or product inspections when deemed necessary due to, among other reasons, product non-conformities found during the quality assurance process, distribution, or sale of the merchandise. All costs associated with re-testing will be the responsibility of the vendor.

PCHI expects that vendors will have questions or require further information. PCHI personnel are readily available to help vendors be in compliance with PCHI policies and the applicable market regulations.

**B. PRODUCTION SAMPLE TESTING PROCESS**

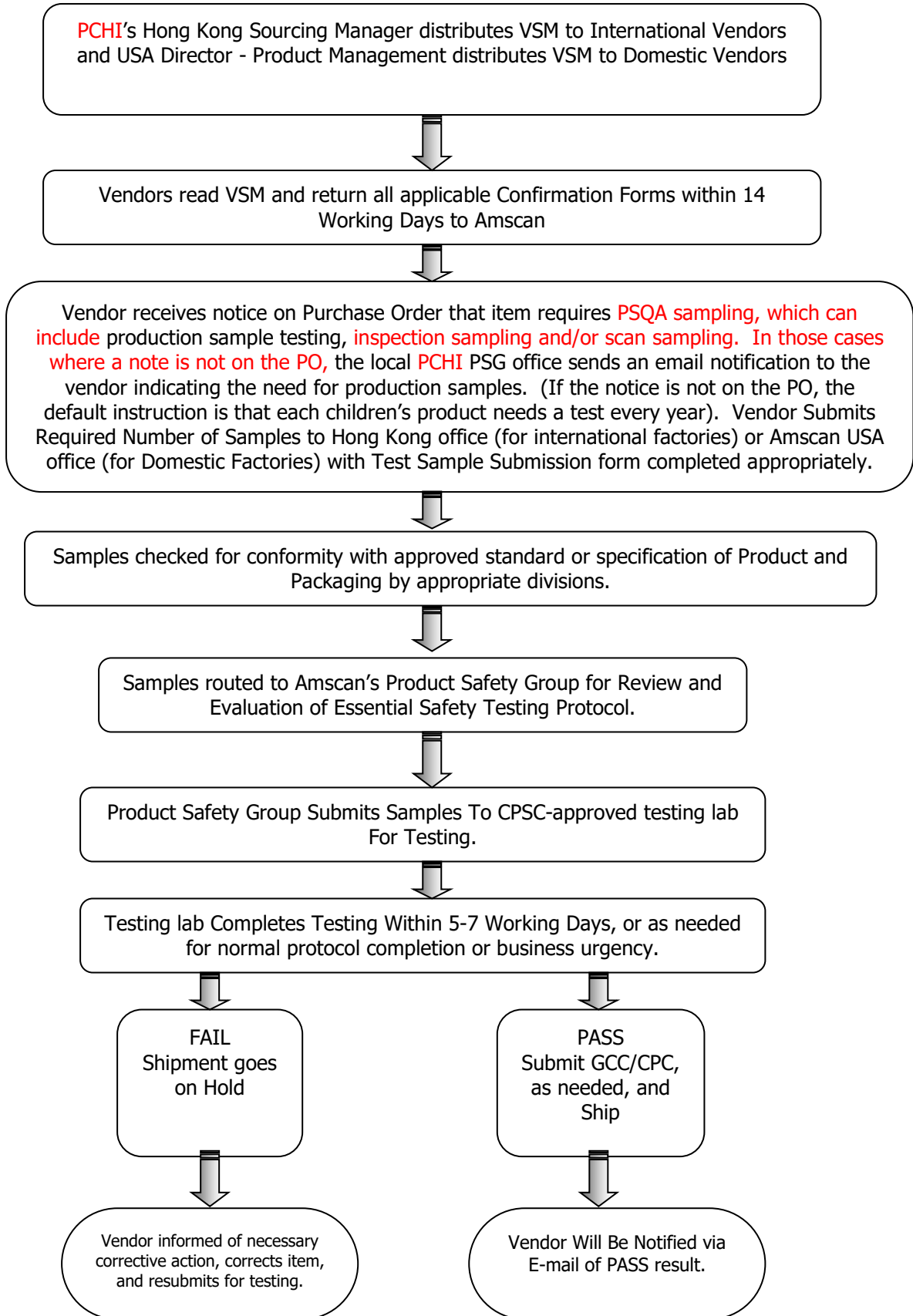

## Section - 6b (Wholesale)

### C. Product Inspection Process (International Order Manufacturing)

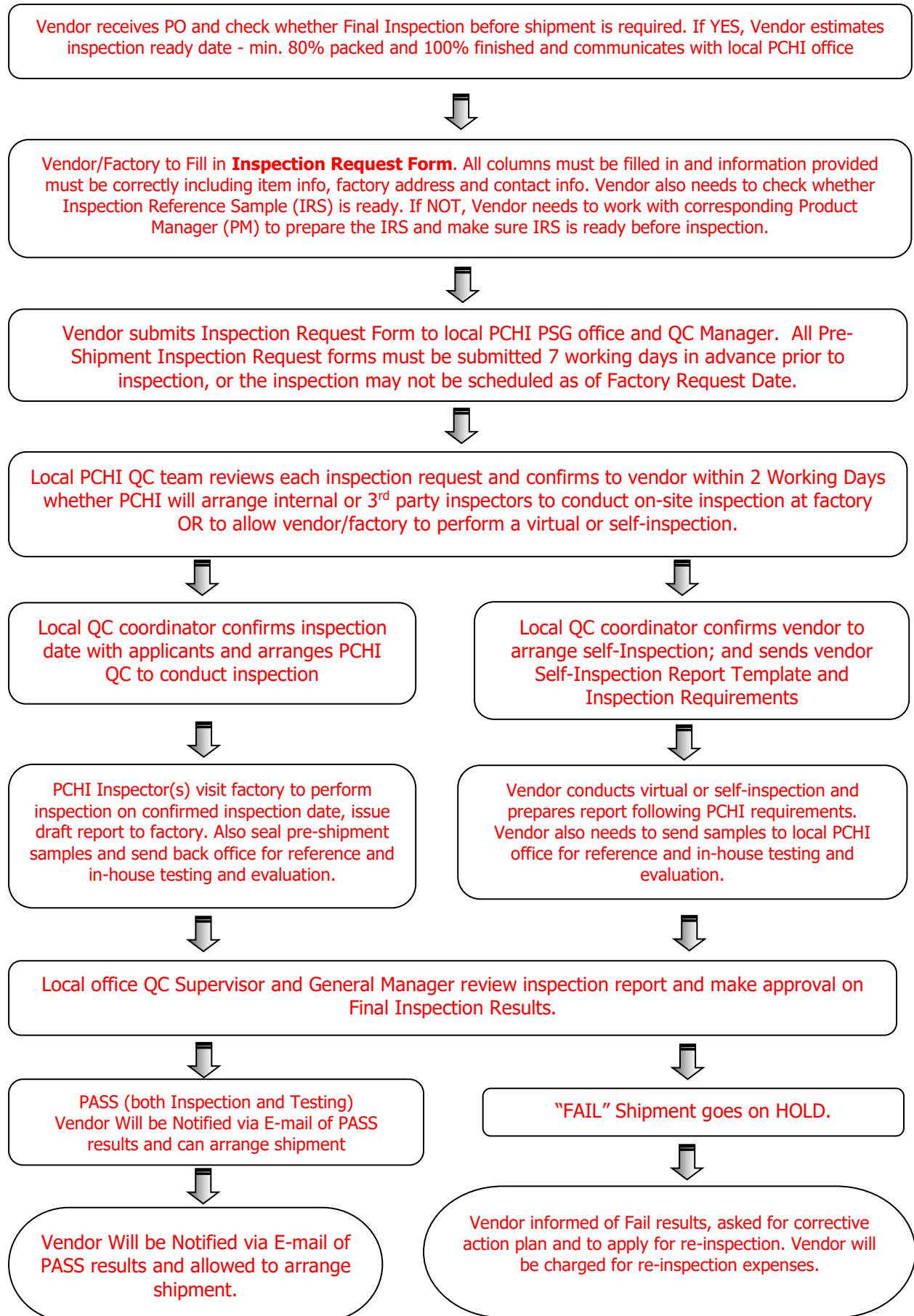

**Inspection Arrangement**

**a) Inspection Application**

- **On-time application:** all inspection applications should be made at least 7 days prior to the requested inspection dates, and at least 4 working days prior to the latest shipment schedule (stated in the order). If your application form is submitted less than above required dates, PCHI may not be able to arrange inspection as of Factory Request Date.
- **Inspection Application Form:** all inspection applications should be done by submitting PCHI Inspection Request Form with all necessary information filled in to our local PSG office. An application will only be deemed complete with all of the following information:
  - Vendor's number under PCHI system, Vendor Name (in English)
  - Factory's ID under PCHI system, Name, address, contact person, phone/mobile phone number (in English and in local language)
  - PO number, Item Code, Description, planned ETD date, Related PCHI, Any special Licensor
  - Requested Inspection Date, inspection Quantity
  - Inspection Reference Sample (IRS) is ready at factory or not

**b) Inspection Penalties**

- **Inspection on Saturday, Sunday, or local public holidays**  
Our QC normally works between Monday to Friday. If vendor requests for inspection on Saturday, Sunday or local public holidays, vendor needs to bear and will be debited for all costs incurred including transportation, accommodation, meal and Over Time pay of minimum USD65 per Order.
- **Goods less than 100% finished Production, less than 80% fully packed**  
During Final Inspection, if vendor has not finished 100% production and 80% fully packed as required upon arrival of the inspector at the factory, vendor will be debited for penalty and bear all other costs including transportation, accommodation, and meal of minimum USD65 per Order.
- **Inspection Abortion due to Wrong Factory Information/Inspection request time**  
Vendor should always provide correct factory address and inspection time. Should vendor have provided wrong address and/or inspection time, vendor will be debited for penalty of USD65, plus the actual traveling costs including transportation, accommodation, and meals.
- **Late change of booked and confirmed inspection schedule - Postponement or putting forward**  
Generally, we do NOT accept any changes after your booked inspection date is confirmed. If there are any necessary changes or cancellation of inspection booking are to be made in less than 48hrs working time prior to confirmed inspection date, vendor will be debited a penalty of USD65 per Order.
- **Missing Inspection Reference Sample IRS**  
If the signed QC sample IRS is missing by vendor or their factory during inspection (due to vendor's mistake), vendor will be debited for penalty of USD25 per item.
- **Re-inspection**  
If there is any Re-inspection required due to problems discovered during the inspection, vendor will have to bear the re-inspection fee of USD65, plus the actual traveling costs including transportation, accommodation, and meals.

**c) Vendor Self-Inspection**

Based on the past performance of vendors/factories, government policies or compliance risk level, including but not limited to COVID protocols, factory compliance, or certification, product testing, inspection, or any occurrence of product quality incidents, PCHI may agree to vendor conducting a virtual or self-inspection. After getting confirmation from PCHI local PSG office, vendors need to conduct virtual or self-inspection following PCHI's Inspection Sampling and AQL standards; and prepare self-inspection report by using PCHI's Vendor Self-Inspection Report Template. PCHI will review vendors' self-inspection report and confirm the Final inspection results. Vendors should only arrange shipment after getting Approval from PCHI for either a virtual, third-party, or self-inspection.

**D. RESPONSIBILITIES**

**PCHI's Responsibilities**

- Update suppliers/vendors on test procedures and protocols, sample submission requirements and performance standards as changes are made.
- Instruct a vendor when testing is required. The purchase order will indicate which items need to have production samples sent for testing and/or the local PCHI PSG office will send an email notification to the vendor indicating the need for production samples. For items manufactured in Asia or other countries, correspondence will be from PCHI's Hong Kong Product Safety Group. For items manufactured in the Americas, correspondence will be from PCHI's New York Product Safety Group.
- The local PCHI Product Safety and Compliance office will be responsible for subsequent review and determination of essential safety test before submission to a CPSC-approved independent, third party testing lab. Local PCHI office will submit samples. For first time testing, vendors are not required to pay testing charges for the submitted samples.
- Testing results and subsequent test reports shall be distributed to vendors through emails by PCHI's local office.
- When PCHI receives a test report from an approved testing lab where the submission has been rated FAIL, PCHI's Product Safety Group will include a recommended corrective action to accompany the FAIL test report. Shipment cannot occur until the vendor takes corrective action and receives a passing test report, or equivalent approval from PCHI. **Vendors who ship products without required PCHI approvals and/or pass testing or inspection reports are subject to penalties as outlined in Sections 2 and 10.** Vendors are fully responsible to pay for any fail testing fees, expenses related to the testing failure(s), and re-test charges should the first test fail due to proven vendors' responsibility including but not limited to the sample's inaccuracy, product non-conformity or defectiveness.

**Vendor Responsibilities**

**Sample Submission Procedure**

- All PCHI vendors (including domestic USA and international vendors) are obliged to follow PCHI testing procedures to submit production samples for testing and where applicable, relevant ingredient, component list, or MSDS (Material Safety Data Sheet) as required for conductance of the appropriate testing protocol (Please see Section 2, for when an MSDS is required). Accordingly, it is the vendor's responsibility to provide products which are compliant with all applicable voluntary and mandatory standards.



## Section - 6b (Wholesale)

- All samples must either be sent to the appropriate PCHI local office for the purpose of centralized handling or directly to the approved testing lab. They will be checked, examined and logged upon arrival.

If Vendors decide to send samples directly to the lab, they must use a CPSC-approved testing lab facility and confirm the applicable test protocols with the local PCHI office prior to sample submission and test request. To find out the closest testing facility to your production facility, visit the CPSC website, [www.cpsc.gov](http://www.cpsc.gov).

- All production testing samples should be sent to the attention of appropriate PCHI local office as follows:

For Overseas (Asia) Manufacturing

PCHI Asia International Ltd  
ATTN: Product Safety Group  
35/F Saxon Tower  
7 Cheung Shun Street  
Lai Chi Kok, Kowloon  
Hong Kong

For Domestic (North/South America) Manufacturing

PCHI  
ATTN: Product Safety Group  
80 Grasslands Road  
Elmsford, NY 10523

For all other contact information, please refer to Section 11.

### Sample Submission Form

Vendors are required to attach a submission form during submission of testing samples to the local PCHI office. The form shall indicate the PCHI item number, Purchase Order (PO) number, item name and description, date manufactured, date sample was sent to PCHI, vendor name, factory address, and vendor contact information. If a vendor is submitting the sample(s) directly to the testing laboratory, the test request form needs to be approved by PCHI's local office.

### Quality Assurance Policy

Should vendors have protocols and or their own quality assurance manual in place, vendor shall provide to PCHI, upon request, the manual applicable for all products provided to PCHI. The manual shall include, but not be limited to the following: inspection protocols, quality assurance procedures and policies, and applicable certifications. In general, the following quality assurance components can serve as a guideline to ensuring that products meet customer expectations and PCHI requirements:

- a) Product Specification: Summary of product's intended and foreseeable use, functional performance, appearance, materials, major components, intended users, and other performance parameters and product attributes deemed necessary.
- b) Product Verification: This can include laboratory testing, Quality Control (QC) inspection, and/or internal evaluation to ensure that the product meets applicable standards. For QC inspections, it is expected that signed and dated inspection reference samples are readily available at the factory and other approval points in the supply chain (**Please see Section 3 for Sample Approval Process**). Requirements for quality testing and inspection will be communicated during the product development process or at the time of purchase order. These requirements include, but are not limited to, testing protocol(s), inspection protocol(s), testing frequency, inspection frequency and type, e.g. During Production or Final Random Inspection, defect classifications, Acceptance Quality Limit(s), and sampling plan(s). Please contact the nearest PCHI office for any questions.
- c) Non-compliant Product: In the event of non-compliant product or packaging with PCHI or regulatory requirements, vendor shall be responsible for remediation in accordance with the terms and conditions contained in this document.

## Section - 6b (Wholesale)

- d) **Packaging Specification:** All product packaging shall meet ISTA standards and/or applicable special packaging guidelines in Section 5.

### Sample Accuracy

- Quantity - Vendors are required to submit production samples at the specific quantity pertaining to the relevant testing protocol. Insufficient samples for testing will result in delay or rejection of submission.
- Approved product specification - Vendors are obliged to submit samples in compliance with PCHI approved product specification. Any deviations to the approved standard will be rejected by the divisions and new production samples to meet approved standard will be demanded for re-submission.
- Approved retail packaging - Vendors must submit complete retail packaging approved by the relevant PCHI division **and in accordance with PCHI specifications and packaging guidelines in Section 5**. Retail packaging includes, but is not limited to, header card, poly-bag, blister clamshell, backer-card, gift box, window box, and instructions for use, as applicable.

### Sample Integrity

Samples with retail package should be well protected to ensure the conditions of sample arrival during transit from vendors to PCHI's local office. Samples found to be damaged or broken will not be accepted for testing and new submission will be immediately required.

### Sample Labeling Arrangement

Since the PCHI local office will handle testing submissions for both US and **EU/UK** divisions, vendors are required to indicate for which market the samples need to be tested by labeling the box as either US, EU or US/EU for easy identification before sample dispatching.

**Note: VENDORS MUST FOLLOW THE TESTING PROCEDURES AS OUTLINED IN THIS SECTION. FAILURE TO DO SO WILL RESULT IN VENDOR'S FULL ACCOUNTABILITY FOR THE DELAY OF TESTING SUBMISSION AND THUS SUBSEQUENT DELAY OF SHIPMENT.**

### Testing Costs

- For first time production sample testing, vendors are not required to pay any testing charge for any samples sent.
- Vendors are responsible for free submission of samples with sufficient quantity for testing.
- Vendors are also responsible for all shipping costs associated with the submission and return of testing sample (sample returns will be by request only).
- Vendors are fully responsible to pay for any fees or expenses associated with a failed test report and re-test charges should the first test fail due to proven vendors' responsibility including but not limited to the sample's inaccuracy, product non-conformity or defectiveness. Vendors are to follow the testing procedures as outlined in this section. Failure to do so will result in vendor's full accountability for the delay of testing submission and thus subsequent delay of shipment. PCHI reserves the right to penalize the vendors by air shipping the merchandise or chargeback the vendors for the loss of profit and from other losses resulting from product defects, product not complying with applicable standards, or product recall due to non-compliance with applicable voluntary or mandatory standards. (Please refer to Section 2, paragraph 13 for vendors' potential remedies required).



### **Approved Testing Lab Responsibilities**

#### Receipt of Samples/ Samples On Hold

Approved testing lab shall notify the test requestor (PCHI's local office PSG (Product Safety Group) or the Vendor) when a test request is placed into an "on hold" status due to receipt of insufficient samples, or any other reason. If the local PCHI office PSG is the test requestor, vendors will be contacted by the local PSG to make resubmission. For purposes throughout this VSM, Approved Testing lab shall mean an independent third party testing laboratory that is approved by the US Consumer Product Safety Commission to conduct testing in accordance with CPSIA.

#### Testing of Samples

Conduct testing and evaluate products in accordance with PCHI testing protocol and mutually agreed practice to comply with applicable local, state and federal regulations. Approved testing lab will notify submitter prior to commencing testing if testing fees are estimated to exceed \$US 200.00 and will not proceed with testing in these cases without written approval from PSG requestor.

#### Reporting of Test Results

Approved testing lab will distribute the testing reports directly to [sp.productreports@Amscan.com](mailto:sp.productreports@Amscan.com) and the test requestor, i.e., Hong Kong, Madagascar, China, Vietnam, or USA PSG. Vendors will be notified of the result via e-mail by the test requestor.

#### Testing Lead Time

Under normal circumstances, products will be evaluated in accordance with the Test Protocols within five to seven working days based on the product type and testing required.

Under certain circumstances, it may not be possible to complete testing on an item within the established timeframe due to conditions inherent to specific test requests or due to the product itself (i.e. UL verification on an electrical product, or candles that have a claimed burn time of 200 hours).

In such cases the approved testing lab, prior to commencing testing, will provide an estimated completion time for the required tests.

PCHI Testing Protocols vary by each individual product and can vary by each style. Test Protocols are subject to change if the product varies from the initial product for which the Test Protocol was developed. Upon receipt of actual samples, it is at the laboratory's option to determine which, if any, additional tests are necessary and to notify the submitter of their recommendation. The laboratory shall receive written approval, from the test requestor, before commencing additional tests that may be necessary.

### **Test Results and Ratings**

Each test report shall indicate the quantitative (numerical values, such as 90 ppm or 0.1 %) and qualitative (Pass/Fail, Comply/Does Not Comply, or equivalent) test result(s) for the parameters evaluated. The report shall also include an overall rating of the final report that is based on the following rating system:

#### **Pass**

The product meets all The Client requirements, including mandatory and voluntary standards, specified in the testing protocol.

#### **Fail**

The product does not meet all The Client requirements, including mandatory and voluntary standards, specified in the testing protocol.

**For Informational Purposes Only**

The product is not judged to pass or fail a specified test protocol but is tested to determine the sample's performance relative to an industry standard.

**Test Report Format**

The following are the identifiable sections to an approved testing lab's test report:

**Report Cover/ Executive Summary**

The Report Cover gives an overview of the testing by showing the overall product rating (Pass, Fail, or For Informational Purposes Only) with a brief executive summary.

The report shall then describe in detail each of the product's failed properties (if any) and any comments and/or recommended courses of action.

**Protocol(s)**

The Test Protocol(s) utilized for testing shall be attached with the report. The Test Protocol provides detailed information regarding the tests performed and the actual data recorded by the approved testing lab during testing.

**Exhibit Page(s)**

Exhibit pages are typically included with a report to show a failure. For example, if a toy failed a sharp edge test, then an exhibit page (picture) shall be included in the report showing the area of non-compliance. In cases of labeling or wording failures, Exhibit pictures shall be taken to document the exact wording and format of a product label.

**Chart(s)**

When appropriate, charts and/or graphs shall be included to show data in test reports.

**Picture Page(s)**

The last page of a test report shall contain a product image of tested item.

**Sample Disposal/Return**

Product testing is fully destructive. All samples are retained by the test laboratory for three months in the U.S. and one month in Hong Kong from the date of submission. Vendors can have samples returned to them provided they accept all costs for re-packaging and shipping and indicate return instructions on the Test Request Form at the time samples are submitted (if submitting directly to lab) or on the Sample Submission Form (accompanying the samples sent to the local PCHI office). Vendors are responsible for all shipping costs associated with the submission and return (by request only) of test samples. Neither PCHI nor the laboratory is responsible for product damage incurred as a result of shipping.

**E. PRODUCT TESTING PROTOCOLS AND GUIDELINES**

**Testing Protocols**

All production samples received by the laboratory shall be tested in accordance with an established PCHI Test Protocol which an approved testing lab can supply to the vendor for their specific product category. If at the time production samples are received, an PCHI Test Protocol does not exist, the laboratory will develop a Test Protocol within 2-3 working days. Additional time may be required for the development of Test Protocols under certain circumstances such as the research and ordering of standards.

## Section - 6b (Wholesale)

Test Protocols are a compilation of various market (U.S., Canada, EU, etc.) regulations and industry standard requirements (i.e. tests) that the product must meet. Test Protocols will be issued by the approved testing lab and then approved for use by PCHI.

In addition, test protocols serve two primary purposes:

1. Provide information regarding what tests will be performed so vendors understand the expectations of PCHI for their products prior to testing. As some items may be slightly different, Test Protocols are to be used as a guideline only and are subject to change. A product-specific Test Protocol will be developed at the sample submission stage if necessary.

2. Test Protocols ensure consistency between laboratories around the world by providing instructions to the approved testing laboratories on what tests are required for specific PCHI products.

- All production samples are to be tested in compliance with PCHI's safety protocol for that market, e.g. US Regulatory safety test to CPSIA, through submission to an approved testing lab.
- PCHI's local office PSG will review all submitted production samples and determine all the appropriate tests with onward submission to an approved testing lab.
- Should there be no appropriate test determined; the approved testing lab will provide a recommended evaluation subject to PCHI approval.
- This final evaluation will be made based on product category, construction, materials, age grading, packaging and labeling review, and product safety requirements.
- Vendors have the obligation to manufacture their products to meet PCHI specifications and all applicable U.S. regulatory safety test requirements for the markets in which the products will be used, including, but not limited to and as specified on the product specification or test request form, the United States, Canada and/or European Union (EU).
- Although product regulatory safety and quality tests vary from product to product, general compliance to the following safety regulations or regulatory body requirements is generally expected:
  - *CPSIA (Consumer Product Safety Improvement Act of 2008)*
  - *Canadian Consumer Product Safety Act (CCPSA)*
  - *Flammability*
  - *Flammable Fabrics Act*
  - *NFPA (National Fire Prevention Association)*
  - *NSF*
  - *Federal Trade Commission*
  - *ASTM International*
  - *Poison Prevention Packaging Act*
  - *Child Safety Protection Act*
  - *Consumer Product Safety Commission (CPSC)*
  - *Textile Fiber Products Identification Act*
  - *Federal Hazardous Substances Act (FHSA)*
  - *Federal Food and Drug Administration (FDA)*
  - *United States Department of Agriculture*
  - *United States Department of Treasury*
  - *United States Food, Drug and Cosmetic Act*
  - *California's Safe Drinking Water and Toxic Enforcement Act (Proposition 65)*
  - *Fair Packaging and Labeling Act (FPLA)*

## Section - 6b (Wholesale)

- *Uniform Packaging and Labeling Regulation (UPLR)*
- *Underwriter Laboratories (UL)*
- *Phthalate restrictions & bans – California Assembly Bill AB 1108*
- *International Standards Organization (ISO)*
- *American National Standards Institute (ANSI)*
- *American Association of Textile Chemists & Colorists (AATCC)*
- *United States Clean Air Act*
- *California Air Resource Board for Formaldehyde in Composite Wood Products*
- *California Air Resource Board for VOC in Aerosols*
- *Labeling of Hazardous Art Materials (LHAMA)*
- *Coalition of Northeastern Governors (CONEG) Toxics in Packaging Clearinghouse (TCPH)*
- *United States Pharmacopeia*
- *Federal and State Mercury in Battery Regulations*
- *Society of Glass and Ceramic Decorated Products*
- *State and Federal Regulations for Bisphenol A Content*
- *Canadian Hazardous Product and Labeling Acts*
- *Victims of Trafficking and Violence Protection Act of 2000*
- *California Transparency in Supply Chains Act of 2010*
- *Bureau of Alcohol, Tobacco, and Firearms*
- *European Toy Safety Directive 2009/48/EC*
- *EU REACH SVHC (Registration, Evaluation, Authorization and Restriction of Chemical substances, namely Substances of Very High Concern for Children's Products)*
- *EU Timber Regulation EU 995/2010 for paper/ and wood – products intended for Europe*
- *USDA Forest Service for paper and wood products intended for USA*
- *Washington State Chemicals of High Concern to Children (CHCC)*
- *Washington State RCW 70A.222.070 – Intentionally added PFAS Chemicals in Food Packaging*
- *Maine L.D 1503 – Stop PFAS Pollution Law*
- *Maine Toxic Chemicals in Children's Products*
- *Oregon High Priority Chemicals of Concern for Children's Health*
- *Vermont Chemicals of High Concern to Children Rule*
- *Vermont 18 V.S.A. Chapter 33A – Chemicals of Concern in Food Packaging (PFAS)*
- *Minnesota SF.20 Section 325F.075 Ban on PFAS in Food Packaging*
- *New York State S08817 Prohibition of PFAS substances in food packaging*
- *Connecticut Public Act 21-191 – intentionally added PFAS in food packaging*
- *California municipality bans on Expanded Polystyrene*
- *SEC Conflict Minerals Rule 17 CFR 240*
- *16 CFR 1107 Testing & Labeling for Product Certification*
- *Food Safety Modernization Act, including 21 CFR 117*
- *RoHS Directive 2011/65/EU for electrics/electronics intended for Europe market*
- *EC No. 1935/2004 for food contact items intended for European market*
- *California Toxic-Free Cosmetics Act (AB 2762)*
- *California CA SB343 Prohibiting the Use of Deceptive Recycling Labels*
- *Maryland House Bill 643 for Cosmetic Products & Ingredient Prohibition (PFAS)*
- *California Cosmetic Fragrance & Flavor Ingredient Right to Know Act (SB 312)*
- *Maryland, Montgomery County Council Bill 33-20 Polystyrene (#6-PS) Ban*
- *OSHA's Nationally Recognized Testing Laboratory (NRTL) Program*
- *Canadian Environmental Protection Act (CEPA) ban on Single use Plastics*
- *New York Seasonal and Decorative Lighting Warning Law (Bill A04522A)*



## Section - 6b (Wholesale)

### Guidelines for Children's and Other Products

This appendix of this VSM contains *PCHI Guidelines for Children's and Other Products*, which can be used, along with PCHI product test protocols, to ensure compliance of vendor's item to all applicable local, state and federal safety regulations. The enclosed version is dated **01/07/2022** and will be updated from time to time. Vendors will receive the updates but are responsible for monitoring changes in regulations as they occur and taking necessary actions to ensure compliance with the most current regulations.

For purposes of compliance with North American regulations, the following definitions are used:

**Children's Product:** a consumer product designed or intended by the manufacturer primarily for children under 14 years of age.

**Toy:** a consumer product designed or intended by the manufacturer primarily for children under 14 years of age for use by the child when the child plays.

**Child Care Article:** a consumer product designed or intended by the manufacturer primarily to facilitate sleep or the feeding of children age 3 and younger, or to help such children with sucking or teething.

**Toy That Can Be Placed in a Child's Mouth:** applies to any part of a toy that can actually be brought to the mouth and kept in the mouth of a child so that it can be sucked or chewed. If a toy or any part of a toy in one dimension is smaller than 5 centimeters, it can be placed in the mouth.

**Proposition 65:** California, and possibly other states in the future, has additional requirements for lead, cadmium, arsenic, mercury, formaldehyde and phthalates in non-children's and other products that may exceed federal requirement. (please refer to <http://www.oehha.org/prop65.html> for more information about California's Proposition 65 requirements and the most recent list of Prop 65 chemicals. For example, lead in Cosmetics cannot exceed 5 ppm in California, where the federal limit is 10 ppm. Also, in California, lead in PVC Coated electrical Cords cannot exceed 100 ppm, where there is not currently a federal requirement for PVC coated cords.

**Electrical and Electronic Products:** All electrical items must have a valid NRTL listing (ETL/UL/CSA, etc.) for plug-in electrical safety, and be listed for electrical safety in both Canada and United States. All battery operated children's products shall meet battery safety and low voltage requirements for toys as outlined in ASTM F963. For battery operated products, where a US safety test is not available, product shall meet reasonable safety standards. For example, products with electronic wire in close proximity to face, head, or body, vendor must provide IEC 60335-1:2010+A1:2013+A2:2016 test for safety verification. Refer to the PCHI Product Testing Protocols Summary's located in the Reference Documents tab on the Amscan vendor portal.

**Effective on February 28th, 2022 any Seasonal and decorative lighting products with nominal 120-volt input voltage rating that contains an electrical cord casing in which lead is present in a quantity greater than 100 ppm, the following warning label shall be attached for sale to New York:**

**"WARNING: HANDLING THE COATED ELECTRICAL WIRE OF THIS PRODUCT MAY EXPOSE YOU TO LEAD. WASH HANDS THOROUGHLY AFTER USE"**

### **Animatronics**

Certain product categories, such as Animatronics, have special functionality requirements that require special approval and quality assurance processes. The following document outlines all responsible parties and requirements that need to be incorporated immediately into the production process for Animatronics and Prop items.

1. PD team will advise supplier and cross functional team of styles to be booked.
2. PD and PCHI PSG team will have Line Review and Risk Assess meeting on all styles and determine the following:
  - a. Testing protocols
  - b. Inspection Protocols (AQL Levels: 4.0/2.5 for Minor/Major – Refer to PCHI Vendor Standards Manual (VSM) for additional details)
  - c. Sample approval process (see point 3 below)
  - d. DUPRO Inspection
  - e. FINAL Random Inspection

\*Factory needs to complete Product Info Template 6 weeks prior to PO placement

\*PCHI PSG Team will send information to Vendor/Factory

### 3. Sample Process

- a. Factory should make 1 development sample (2 samples if licensed product).
- b. After the development sample is approved, factory to make 2 PP (pre-production) approval samples (3 if licensed product). These PP approval samples will reflect all changes made to development sample. These samples should be sent approximately 1 month after development sample approval.
- c. 1 PP sample should be held at factory
- d. 1 PP sample should be held in US PD home office
- e. 1 PP sample sent to Licensor if necessary
- f. Factory will take photos of PP approval samples, as well as, videos of sample function/sounds, movements, or anything else pertinent and share with the US PD Team. The US PD team will review videos and photos for final inspection and send to PCHI PSG Team share drive.
- g. Factory will send US PD team min 2 TOP (top of production) samples
  - i. 1 for US PD home office
  - ii. 1 for Licensor (if applicable)

\*PP samples will not be made with actual bulk fabrics and raw materials.

\*TOP samples must be representative of bulk production 2

4. Factory to send manuscript "how to" information as applicable to PD team and PCHI PSG Team. It should be sent 1 month prior to when packaging is due.
5. Factory will contact PCHI PSG team to set up Production Readiness meetings for ALL styles. Ideally this meeting should happen 2 weeks prior to production start date.
  - a. Attendance for this meeting should include a representative from Factory, US Supplier and PCHI PSG Team. Virtual attendance of PD and/or US Sourcing team is optional as needed.
  - b. At this meeting, Factory and PCHI PSG team will align on:
    - i. Testing criteria
    - ii. Inspection AQLs
    - iii. Critical points of measure (see PD checklist below)
    - iv. Risk – factory to be transparent of actual issues/concerns for all styles
    - v. All critical milestones needed to hit delivery
      1. DUPRO timing (approx. 20% of production done)
      2. Final inspection dates



## Section - 6b (Wholesale)

\*DUPRO and Final inspections are to be done in factory with PCHI PSG team. Virtual option can be arranged inclusive of PD and/or Sourcing if required\*

6. Factory should comply with all requirements in PCHI VSM and involve PCHI PSG team during Production Readiness meetings, DUPRO and Final inspections.
7. Factory should follow all inspection and testing protocols (some examples are noted below, but not limited to) in the PCHI Line Review Summary, and on the PO.
  - a. For non-electrical items, ASCN-2500 standard decoration testing protocol is applicable, plus other protocols based on components, for example batteries, feathers, or other materials.
  - b. For anything that includes a battery, like a try me, we add ASCN-160.
  - c. For electrical items (plug in items), we use ASCN-1100 and add ASCN-2500 or ASCN-1800, depending on PCHI requirements which will be provided to the vendor prior to PO.
  - d. Incorporate a use and functionality check for the QC inspector to observe during DUPRO and FINAL inspections to troubleshoot any issues which would be experienced by the customer.
  - e. Drop Test (included in the overall hardgoods inspection protocol).
8. PCHI PSG team will follow the below checklist during inspections:
  - a. Product matches total size of approval sample L x H x W
  - b. Product molded parts match size/sculpt definition/paint execution/paint color of approval sample
  - c. Product apparel matches construction and appearance of approval sample (color, intentional staining, etc.)
  - d. Product hair styling and color matches approval sample
  - e. Product function matches approval sample
    - i. Motion type and range of motion
    - ii. Motion activation
    - iii. Audio matches
    - iv. Light function and color match
  - f. Packaging matches approval sample
    - i. Packaging format, type, color
    - ii. QR code works
  - g. Packing matches TOPS document
    - i. Inner Pack Count
    - ii. Inner Pack Type (Box, Bag)
  - h. Licensed Product Includes – Legal line (per approval sample) and Sew In Label (if applicable)
    - i. Reference document for each individual item (supplied by PD team)
9. Factory must have a PASS PCHI inspection report BEFORE releasing a PO for shipment. Any inspections that are in question should be directed to the US Product Manager.
10. All PO's will be inspected upon receipt in Chester warehouse

Wherever a state requirement is more stringent than a federal requirement, PCHI requires compliance with the standard that meets both the state and federal requirements.



## Section - 6b (Wholesale)

### F. VENDOR QUALIFICATION & SOCIAL COMPLIANCE CERTIFICATION

#### Vendor Qualification

As part of PCHI's commitment to product quality and safety, new or potential suppliers need to be qualified to conduct business with PCHI. Prior to issuance of a purchase order, PCHI personnel will conduct a qualification survey on the following areas:

1. Business Information
2. Management & Personnel
3. Factory Facilities for Design and Manufacturing (Good Manufacturing Practices)
4. Quality Management System
5. Social Compliance Evaluation
6. Qualitative Evaluation for Management & Personnel
7. Design and Manufacturing Capability
8. Process and Product Quality Control
9. Final Product Traceability
10. Observations of Critical Factory Areas

The results of this survey will be reviewed with personnel from Product Management, Sourcing, and the applicable business units within PCHI to determine the viability of new vendors.

#### Vendor Certification for Social Compliance

As part of PCHI's commitment to responsible and ethical business practices, all PCHI suppliers shall provide a socially compliant work environment. **Suppliers can include manufacturing facilities, distributors, or importers.** PCHI requires its suppliers to comply with applicable local laws, standards and the principles put forth by **the International Labor Organization (ILO) and by its customers and licensors** in the following areas and summarized in PCHI's Supplier Code of Conduct referenced in Section 1 and enclosed in the Appendix of this VSM:

- Management Systems
- Child Labor
- Forced Labor
- Health & Safety
- Freedom of Association and Collective Bargaining
- Non-Discrimination
- Immigration Law Compliance
- Disciplinary Practices
- Harassment & Abuse
- Compensation & Benefits
- Hours of Work
- Environmental Compliance
- Customs Compliance
- Security
- Sub-Contracting
- Homework





## Section - 6b (Wholesale)

A Certification Audit done by an independent, third party auditing firm, including, but not limited to, Intertek, SGS, Eurofins, Bureau Veritas, HAP (Hire a Partner), or Elevate, that incorporates ILO standards and/or those standards of an applicable retail customer, licensor, brand or other third party in these areas is required as part of PCHI's factory approval process and will be requested and/or verified. Applicable factories are those factories which are being used to produce PCHI-branded merchandise or where PCHI is the importer of record of the factory's manufactured merchandise.

Resolution of all corrective actions, as well as the cost of repeat audits necessary for compliance or to receive certification, will be the responsibility of the vendor and/or factory. Audits are generally deemed to be current if they have been done within the past twelve months. Audits will be reviewed and approved if the factory is deemed to be operating in accordance with PCHI's minimum compliance standards, which generally align with SEDEX 4 Pillar or WRAP (Worldwide Responsible Accredited Production – Universal Code) audit standards. Audits performed by independent, third-party audit firms to equivalent standards, including ICTI, SA8000, BSCI, WCA, Better Work Programme, or other equivalent standard will be considered.

In addition, in light of recent reports of forced labor and human rights allegations regarding China's Xinjiang province and the Uyghur ethnic/religious group, U.S. law and enforcement measures, including the Xinjiang Supply Chain Business Advisory, the recently passed Uyghur Forced Labor Prevention Act, and other global initiatives. Please refer to:

- PCHI Supplier Code of Conduct in PCHI's Vendor Standards Manual (VSM) Section 1 which specifically states that suppliers shall not use any forced or involuntary labor, whether, prison, bonded, indentured or otherwise.
- PCHI reserves the right to randomly audit and confirm that below actions have been made:
  - Entire Vendor supply chain has been mapped, including the manufacturing facility itself, suppliers, components and raw materials, to ensure that none come from Xinjiang;
  - Vendor has investigated whether its China suppliers are sending products to facilities in Xinjiang as unauthorized sub-contracting;
  - Vendor has requested of its suppliers the need to report the China province source of migrant workers and conduct due diligence on the supplier's factory to identify any government program(s) which relate to this issue;
  - Vendor confirms that products do not contain cotton; otherwise, Vendor has started a cotton investigation process as below:
    - Require that factories report cotton country source(s);
    - If cotton is sourced from China, factories are required to report regional origin, including province and city;
    - Require that factories have a chain of custody program to trace cotton;
    - Review documentation, such as sales invoice or transport documents to verify cotton source.
    - If there was any evidence or suspicion of suppliers or cotton connected with Xinjiang and/ or government-sent Uyghurs to other regions of China, Vendor will alert PCHI.

## Section - 6b (Wholesale)

### CPSIA and Safety Requirement Guidelines Acknowledgement

The Consumer Product Safety Improvement Act of 2008 (CPSIA) changed the safety requirements of many items sold by PCHI. As part of PCHI's commitment to fully comply with CPSIA, it is mandatory that products supplied to PCHI by its vendors covered under the Consumer Product Safety Improvement Act of 2008 (the Act) be in compliance with all requirements of this legislation. This includes, but is not limited to, the following areas of the Act:

- Children's products containing lead and the lead paint rule. (Title I – Section 101 of the Act)
- Mandatory third party testing for certain children's products and certification requirements. (Title I – Section 102 of the Act)
- Tracking labels for children's products. (Title I – Section 103 of the Act)
- Labeling requirements for children's toys and games, and the vendors obligation to provide the necessary cautionary statement information required by the Act. (Title I – Section 105 of the Act)
- Mandatory toy safety standards. (Title I – Section 106 of the Act)
- Prohibition on sale of certain products containing specified phthalates. (Title I – Section 108 of the Act)

#### Food, Cosmetics, and Products that come into contact with Food

Vendors that supply PCHI with cosmetics, food, and products that come into contact with food are required to comply with all U.S. FDA (Food and Drug Administration) regulations, the Food Safety Modernization Act (FSMA), U.S. FDA CFR Title 21, including but not limited to Part 117, and Proposition 65 regulations. For those facilities that produce food and cosmetics, the following documentation, with satisfactory result(s) is required, but not limited to: i) factory contact & address, ii) applicable GMP facility certification audit, or equivalent, iii) product test report(s) in accordance applicable test protocols, iv) packaging claims and independent, third party substantiation, v) certificate(s) of insurance, vi) product and process inspection plan in accordance with FDA or equivalent methodology, vii) current social compliance audit per PCHI Code of Conduct requirements, viii) current FDA bioterrorism registration certificate, and ix) applicable country certification(s) required by local or national law. **In accordance with California Toxic-Free Cosmetics Act (AB 2762), all cosmetic items shall not contain any intentionally added PFAS chemicals. For more information, please refer to Adherence to California Proposition 65 & Future California Toxics in Cosmetics law AB 2762. Similarly, other states in the US have pass laws prohibiting PFAS chemicals in all Food Packaging. Please refer to the PFAS letter for Food Packaging items. Both letters are available on the vendor portal. Any cosmetic containing Titanium Dioxide shipping to any EU countries must be under EU 10,000 ppm.**

#### Certification and Testing Documentation

Vendors must certify (with a GCC as applicable) based on a test of each product they supply PCHI or upon a reasonable testing program that all product that PCHI purchases complies with all rules, bans, standards, or regulations applicable to that product under the Consumer Product Safety Act of 2008, any other Act enforced by the Consumer Product Safety Commission (CPSC), and all U.S. FDA Codes of Federal Regulations (CFR).

If revisions to this Act, other CPSC Acts, U.S. FDA CFR's, or future consumer safety legislation or regulation results in additional or alternate safety requirements, PCHI's vendors are required to meet those standards. This includes, but is not limited to, requirements specified in this Vendor Standards Manual and state regulations of Proposition 65, CONEG Toxics in Packaging regulations, or any other applicable laws.

To acknowledge your receipt of this VSM's Product Safety and Quality Assurance requirements, please indicate which PCHI entity you are supplying, sign and date this document to certify that all products you supply to the PCHI entity are in compliance and will continue to be in compliance in the future, with the Consumer Product Safety Improvement Act of 2008, other Consumer Product Safety Commission Acts, and all applicable U.S. FDA or state regulations. Please return a copy of the signed



### **Section - 6b (Wholesale)**

and dated document to the fax number of the applicable PCHI entity representative. (All PCHI entity contacts are listed in Section 11 of this Vendor Standards Manual).

For your reference, Guidelines for Children's and Other Products is enclosed in the appendix.



## Section - 6b (Wholesale)

### State Chemicals in Children's Products

There are certain chemicals which have notification and/or regulatory requirements for the states of Maine, Oregon, Vermont, New York and/or Washington in the United States. If your product(s) contain chemicals from the PCHI Chemical List (last updated on **01/04/2022**, made available on Amscan's Vendor Portal, and updated from time to time) that are unintentionally added to children's products above the Practical Quantitation Limit (PQL), which, for practicable purposes, is 100 ppm (0.01%), please inform PCHI of the chemical name and amount by weight of the chemical in the product. [Please note that the PQL is based on the test methodology used for chemical detection]. If you have testing done to levels below 100 ppm for any chemicals on the PCHI Chemical List that are intentionally added, then please inform us of the level to which the chemicals are being measured and the level of the chemical.

Some chemicals with a check mark on the PCHI Chemical list for SVHC also have a check mark for Maine, Oregon, Vermont, New York and/or Washington State. These chemicals, if present, need a corrective plan to find a suitable replacement. Note that Lead (Pb), Cadmium (Cd), Arsenic (As), Antimony (Sb), Mercury (Hg), Bisphenol A (BPA), Formaldehyde, and Phthalates DBP, DEHP(DOP), BBP, DINP, DNOP, DIDP, DIOP, DIBP, DPP(DPENP), DNHP(DHEXP), DCHP, DEP, and MBP (CAS#131-70-4) do not require notification since a control program as stated in this Vendor Standards Manual ("VSM") and PCHI's Guidelines for Children's and Other Products is in place to ensure that the products you supply to PCHI and its affiliated companies comply with applicable local, state, and federal regulations for these chemicals. For example, Lead in surface coating and substrate needs to be under 40 or 90 ppm, depending upon product category, and under 1 microgram using the NIOSH 9100 test according to California Proposition 65 regulations, Phthalates need to be under 1000 ppm (0.1%), and total Cadmium needs to be under 75 ppm.

### CFR 1107

As part of US federal regulation 16 CFR 1107 requirements effective February 8, 2013 for children's items, PCHI needs to ensure that all items comply with applicable regulations.

In addition to the current periodic production testing, GCC or CPC, and random sampling that PCHI is already doing with your cooperation, please ensure the following:

1. You inform PCHI of any significant changes in materials, factories, processes, designs, or construction for children's items that you manufacture for PCHI. A sample Product Change Notice (PCN) form is enclosed in this section for your use or reference. For children's products and other regulated product categories covered by state or federal government rules and regulations, specific material content information will be required. In these cases, you will be requested by the local PCHI office to provide applicable Bill of Material (BOM) information that will help ensure compliance with government regulations. Failure to provide complete and accurate BOM information may result in your products not being able to be sold in the applicable government jurisdiction.
2. Your company has on file, and viewed by all, a written policy statement from a company officer stating that the exercise of undue influence on third party conformity assessment bodies is not acceptable, a letter to all appropriate staff members to receive training on this policy, and a signed statement attesting to their participation in such training.

If there are any reports of alleged undue influence, please investigate immediately and inform PCHI as soon as possible. If you have any questions on the requirements of 16 CFR 1107 or your obligations to PCHI, please contact us immediately.



**HALLOWEEN CITY**



**Section - 6b (Wholesale)**

## **2022 CPSIA and Safety Requirement Guidelines Acknowledgement**

If you have any questions, please contact the respective representative of PCHI's entity anytime.

PCHI Entity \_\_\_\_\_

Vendor Signature \_\_\_\_\_

Printed Name \_\_\_\_\_

Title \_\_\_\_\_

Company Name \_\_\_\_\_

Date of Signature \_\_\_\_\_

**Please refer to *PCHI Guidelines for Children's and Other Products* on the website for a summary of specific product safety requirements (Vendor Compliance Guidelines - Wholesale PDF).**

All wholesale vendors in Asia that ship to Amscan must complete and email this acknowledgment form to [vendorrelations@amscan.com](mailto:vendorrelations@amscan.com) or fax to 914-784-4302.

All wholesale vendors in Asia that ship to Anagram International must complete and email this acknowledgement form to **Valerie Luebke**, Quality Manager at [luebkev@anagramintl.com](mailto:luebkev@anagramintl.com) or fax to 952-949-6470.

All wholesale vendors in North and South America that ship to PCHI must complete and email this acknowledgment form to [vendorrelations@amscan.com](mailto:vendorrelations@amscan.com) or fax to 914-784-4302.

All Full Case vendors that ship to an Amscan Entity must complete and email this acknowledgment form to [vendorrelations@amscan.com](mailto:vendorrelations@amscan.com) or fax to 914-784-4302.



## CHILDREN'S PRODUCT CERTIFICATE / GENERAL CERTIFICATE OF CONFORMITY

CERTIFICATE DATE:		<b>Importer: (Name, Address &amp; Phone #)</b>
CERTIFIED BY:		Amscan Inc.
MANUFACTURER NAME:		80 Grasslands Road
ADDRESS:		Elmsford, NY USA
CITY:		914-784-1910
STATE/PROVINCE:		<b>Importer: (Record Keeping Contact)</b>
COUNTRY:		VP - Product Safety
PHONE#:		80 Grasslands Road
		Elmsford, NY USA
		914-784-1910/minzalac@amscan.com

Item Number	Item Description	Vendor Number	Purchase Order #	Date of Manufacture (Month/Year)	Place of Manufacture (Factory Name, Address & Phone #)	Testing Date (Month/Year)	Place of Testing/ Third Party Testing Lab (Name, Address & Phone #)

In accordance with Section 14 of the Consumer Product Safety Act, 15 U.S.C. 2063(a), the manufacturer certifies that based upon a test or a reasonable test program, the product listed above complies with all applicable consumer product safety rules, bans, regulations or standards under the Consumer Product Safety Improvement Act (CPSIA) of 2008 or any other Act enforceable by the United States Consumer Product Safety Commission, as indicated in Table 1 below (check all that apply). Also check all applicable FDA or Prop 65 regulations. Double click grey box and select "Checked"

Check All

That Apply

**Table 1: Consumer Product Safety Rules (Children's Products)**

- |                          |  |                       |
|--------------------------|--|-----------------------|
| <input type="checkbox"/> | Lead in Surface Coating (Children's Product) | 16 CFR 1303           |
| <input type="checkbox"/> | Lead in Substrate (Children's Product)       | CPSIA 101             |
| <input type="checkbox"/> | Lead in Children's Metal Jewelry             | CPSIA 101(a)(2)       |
| <input type="checkbox"/> | Choking Hazard Labeling (Children's Product) | 16 CFR 1500.19        |
| <input type="checkbox"/> | Pacifiers (Children's Product)               | 16 CFR 1511           |
| <input type="checkbox"/> | Rattles (Children's Product)                 | 16 CFR 1510           |
| <input type="checkbox"/> | Children's Products with Liquids             | 16 CFR 1500.14        |
| <input type="checkbox"/> | Toys (ASTM F963)                             | CPSIA 106             |
| <input type="checkbox"/> | Flammability of Solids (Children's Product)  | 16 CFR 1500.44        |
| <input type="checkbox"/> | Flammability of Textiles (Adult & Child)     | 16 CFR 1610           |
| <input type="checkbox"/> | Flammability of Plastic Film (Adult & Child) | 16 CFR 1611           |
| <input type="checkbox"/> | Phthalates in Toy & Childcare Items          | CPSIA 108             |
| <input type="checkbox"/> | Art Materials (LHAMA)                        | 16 CFR 1500.14(b) (8) |

**Table 2: OTHER TESTING**

- |                          |                                     |                          |                                |
|--------------------------|-------------------------------------|--------------------------|--------------------------------|
| <input type="checkbox"/> | TRA                                 | <input type="checkbox"/> | USP 61/62 and/or USP 51        |
| <input type="checkbox"/> | Formaldehyde testing (under 75 ppm) | <input type="checkbox"/> | FDA Ingredient/Labeling Review |
| <input type="checkbox"/> | Lead in Cosmetics                   | <input type="checkbox"/> | Mercury in Cosmetics           |
| <input type="checkbox"/> | FDA testing (specify FDA test #)    | <input type="checkbox"/> | California Prop 65 Phthalates  |
| <input type="checkbox"/> | California Prop 65 lead             |                          |                                |

"NOTE: Manufacturer shall email this WORD document using the naming format: **Item#\_Vendor#\_Certificate Date with MMDDYYYY** (For example, item 123456 from vendor number 999 made on November 12, 2008 would be 123456\_999\_11122008.doc) to the following distribution: [sp.gcc@amscan.com](mailto:sp.gcc@amscan.com).

## PRODUCT CHANGE NOTICE (CHILDREN'S PRODUCTS)

DATE:

MANUFACTURER NAME:

ADDRESS:

CITY:

STATE/PROVINCE:

COUNTRY:

PHONE#:

Importer: (Name, Address & Phone #)
Importer: (Record Keeping Contact)

Item Number	Item Description	Vendor Number	Purchase Order #	Date of Manufacture (Month/Year)	Place of Manufacture (Factory Name, Address & Phone #)

In accordance with 16 CFR 1107 Testing and Labeling pertaining to Product Certification the manufacturer, in accordance with requirements put forth by United States Consumer Product Safety Commission, is informing Party City Holdings Inc. of the following significant product changes:

Check All  
That Apply

**PRODUCT CHANGE: CHILDREN'S PRODUCTS**

- MATERIALS (Change in Bill of Materials for a child item or its components)
- FACTORY (Change in manufacturing location for a child item or its components)
- PROCESS (Change in the way the child item or its components are produced)
- DESIGN (Change in size, shape, color, or functionality of the child item or its components)
- CONSTRUCTION (Change in how the child item or its components are assembled or put together)

Upon receipt of an item's Product Change Notice (PCN), a more detailed inquiry will be undertaken by PCHI as needed.

"NOTE: Manufacturer shall email this WORD document using the naming format: **Item#\_Vendor#\_PCN\_Date with MMDDYYYY** (For example, item 123456 from vendor number 999 made on February 9, 2013 would be **123456\_999\_PCN\_02092013.doc**) to the following distribution: [kelatur@amscan.com](mailto:kelatur@amscan.com) and [minzalac@amscan.com](mailto:minzalac@amscan.com)



## GENERAL CERTIFICATE OF CONFORMITY FOR CONSUMER PRODUCTS

**CERTIFICATE DATE:**

**CERTIFIED BY:**

**MANUFACTURER NAME:**

**ADDRESS:**

**CITY:**

**STATE/PROVINCE:**

**COUNTRY:**

**PHONE#:**

Anagram International
7700 Anagram Drive Eden Prairie, MN 55344
USA
952-949-5600

Item Number	Item Description	Date of Manufacture (Month/Year)	Place of Manufacture (Factory Name, Address & Phone #)	Testing Date (Month/Year)	Place of Testing/ Third Party Testing Lab (Name, Address & Phone #)

In accordance with Section 14 of the Consumer Product Safety Act, 15 U.S.C. 2063(a), the manufacturer certifies that based upon a test or a reasonable test program, the product listed above complies with all applicable consumer product safety rules, bans, regulations or standards under the Consumer Product Safety Improvement Act (CPSIA) of 2008 or any other Act enforceable by the United States Consumer Product Safety Commission, as indicated in Table 1 below (check all that apply):

**Check All  
That Apply  
Products)**

**Table 1: Consumer Product Safety Rules (Children's & Other Applicable**

- |                          |                                     |   |
|--------------------------|-------------------------------------|---|
| <input type="checkbox"/> | Lead in Surface Coating             | 16 CFR 1303   |
| <input type="checkbox"/> | Lead in Substrate                   | CPSIA 101   |
| <input type="checkbox"/> | Choking Hazard Labeling             | 16 CFR 1500.19  |
| <input type="checkbox"/> | Toys (ASTM F963)                    | CPSIA 106   |
| <input type="checkbox"/> | Flammability of Solids              | 16 CFR 1500.44  |
| <input type="checkbox"/> | Phthalates in Toy & Childcare Items | CPSIA 108   |
| <input type="checkbox"/> | Other (please specify)              | <table border="1" style="width: 100%; height: 20px;"></table> |
| <input type="checkbox"/> | Other (please specify)              | <table border="1" style="width: 100%; height: 20px;"></table> |





## Section 7 – Wholesale

### Imports

#### Overview

PCHI (Party City Holdings Inc) is a worldwide importer and seeks to follow international trade guidelines. Due to the complex routing and documentation procedures of Imports, PCHI encourages vendors to read and follow instructions thoroughly. Note shipping guidelines are generalized and may vary with each vendor, country of origin, or PO. Contact the designated PCHI Logistics team with any questions. Refer to the PCHI Logistic team charts within this section for contact information. Please note, with the merger of Amscan Inc. and Party City, many of the Party City vendors will now be ordered through Amscan or Anagram International. We appreciate your cooperation in complying with the standards established for PCHI's Import program.

Review all sections in the Import section, as it thoroughly explains the documents required and when each must be forwarded to various designated parties.

#### ISF

US Customs and Border Protection has implemented a new initiative called ISF (Importer Security Filing; also referred to as 10+2). US Customs requires the following ten data elements to be sent electronically to them before the container is allowed to be loaded aboard a vessel. The information must be transmitted to US Customs electronically 48 hours before loading; therefore, the information must be furnished to the PCHI designated forwarder 5 working days before the freight is available for pick up at your location. PCHI will furnish #7 and #8 directly to the forwarder. #10 will be on the purchase order.

1. Manufacturer Name and Address: the last factory to 'finish' the goods
2. Seller Name and Address: last known entity by whom the goods are sold
3. Buyer Name and Address: last known entity by whom the goods are purchased
4. Ship To Name and Address: name and address of first delivery
5. Container Stuffing Location Name and Address: physical location where the container was stuffed
6. Consolidator Name and Address: the party who arranged the stuffing
7. Importer of Record Number: Amscan or Anagram International IRS#
8. Consignee Number: who's account merchandise is shipped
9. Country of Origin: where the goods were made
10. HTS#: require up to the 6<sup>th</sup> digit of the HTS for each item

Steamship lines will be required to furnish these next two items:

1. Vessel Stow Plan: Customs will require this 48 hours after departure
2. Container Status Message

US Customs has begun assessing penalties of \$5000 per incident for filings that are untimely or have incorrect or missing information. PCHI will not be responsible for any penalties due to a vendor's late filing. If this does occur, vendors will be assessed in the amount of the penalty along with a \$500 additional charge.



## Section 7 – Wholesale

### General Conformity Certificate (see section 6 for more information and forms)

In accordance with the new laws put forth by the Consumer Product Safety Improvement act of 2008 (CPSIA) a General Certificate of Compliance (GCC), also referred to as a Children's Product Certificate (CPC) for products intended for users under 14 years old, will need to be provided with shipments of toys and children's items, and other applicable products, such as wearing apparel, lighters, art materials, etc., regulated by the CPSC, that are manufactured after November 11, 2008. (GCC form is at end of this section and in section 6). For PCHI, the certificate applies mostly to children's products that are primarily intended for use by children 14 years of age and under, but there are some other product categories that fall under the jurisdiction of the Consumer Product Safety Commission, such as wearing apparel and art materials. Items requiring the GCC will be specified on our purchase orders.

The GCC is verification that an item has passed the required tests for the US market, which are currently done when you send production samples to PCHI's local office for test submission or directly to the lab for testing. **If the item is Amscan branded, one of PCHI's offices will request the sample and perform the testing. If the items are non-Amscan branded, such as Amscan distributed items, where Amscan is importing the item, the Vendor is responsible for sending samples directly to a lab for testing and would have to create a GCC based on their own test.** On the applicable items, a PASS test report will need to have been received or verified, and the GCC completed, before shipping the item.

The GCC needs to be submitted with the shipping documents and a copy must also be sent via email to the PCHI database at the email addresses listed at the bottom of the GCC document. The email certificate may be sent as soon as a "Pass" test report is either received or confirmed by the local PCHI office. It is important to have the certificate and pass test report confirmations before shipment since PCHI's brokers will not accept the booking without the proper GCC. PCHI can accept prior test reports as evidence as long as:

- 1) the materials, design, processes and factory are the same for the items sent to Amscan as the production sample(s) that were submitted for testing within the past year, and
- 2) the test report(s) contain all applicable tests in accordance with a reasonable test program. For example, toys were tested for phthalates, ASTM 963, and lead and other heavy metals in surface coatings & substrates.

### PCHI Purchases International Shipments via the Below INCO Terms:

#### 1. Free on Board (FOB) (CY-CFS or EDC)

Vendors are responsible for delivery to PCHI's designated freight forwarder or **any** of contracted direct ocean carriers. PCHI is responsible for import freight costs and customs clearance and takes possession of goods **per the Incoterms on our PO's**. This includes full container loads, less than container load (LCL), cargo, air, and ocean shipments. Vendor is to contact the designated PCHI **Transportation** team for local forwarder/ocean carrier information. Any deviation from the policy will result in the reimbursement charges.

Air shipments, where PCHI is responsible only for the ocean charges, will be calculated based on the applicable rates for container shipments on the date of the shipment. Calculations based on LCL rates or carton dimensions are not acceptable.

**Airfreight requests are streamlined through the Inventory Planning term. Upon request approval, Inventory Planning contacts the Inbound Transportation Team to nominate the airfreight service provider.** The PCHI designated **Transportation** team is responsible for **the approval of all charges** before the PO is shipped. No charges will be paid unless vendors seek approval from the Import team in advance. All approvals must be in writing or email.



## Section 7 – Wholesale

### 2. Delivered Duty Paid (DDP) Delivered to DC

Vendors are responsible for delivery to the PCHI Distribution Center door, including all freight costs, duties, and customs clearance under vendor’s own importer of record number. PCHI takes possession of goods upon receipt at our DC locations.

### 3. Landed Duty Paid (LDP)

Vendors are responsible for delivery to the port of entry, which can include the terminal railhead located nearest to the PCHI DC destination. LDP includes all freight costs and customs clearance under the vendor’s own importer of record number. PCHI takes possession of the goods after clearing customs.

For LDP shipments the vendor is responsible for all labeling and EDI as outlined in this Vendor Standards Manual.

### Import Shipping/FOB

1. All terms are FOB Port or PCHI nominated CFS. **When the Vendor account is established**, the PCHI Logistics Import team will nominate a forwarder/consolidator/ocean carrier for all shipments. Location will be listed on the PO. Instructions will be given once country of origin and port of loading is confirmed.
2. Merchandising/Product managers may not change/assign routing or change INCO terms. All requests for changes to routing or terms for carriage must be sent to the designated PCHI Logistics Import Manager or Vice President of Transportation and Supply Chain in writing at least **forty-two (42)** business days prior to the vendor ship date.

PCHI will utilize our forwarders order management system for all shipments. Vendors must ensure compliance with ISF filings and other US Customs regulations. All Factory loads are to be made through the PCHI designated freight forwarder using their order management system. Vendors must seal factory container loads using industry standard seals. All loads must not exceed the U.S. weight restrictions. All LCL loads will also be managed through our designated forwarder utilizing the order management package to ensure compliance. In the future, shipment booking will be required to be completed on-line through our designated forwarder’s portal.

3. Factories **are encouraged** to be Customs-Trade Partners Against Terrorism (C-TPAT) certified.
4. Containers must meet Cubic Meter (CBM) minimum requirements. All LCL shipments require written approval from the designated PCHI Logistics Import team. Vendors are financially responsible for under-utilized containers based on minimum CBM requirements as listed below.

Container	Cubic Meter
20 (TEU)	28 CBM
40 (FEU)	58 CBM
40H (FEU)	65 CBM
45 (FEU)	68 CBM
48 (FEU)	72 CBM

## 5. **Container Loading Security**

In accordance with the Company's commitment to security requirements, all Suppliers, forwarders or contracted agents are required to:

- Inspect all containers prior to loading to ensure their security. This 7-pt container inspection will include the following areas: front wall, left side, right side, floor, ceiling or roof, inside and outside doors plus the outside and undercarriage. The supplier must also confirm the reliability of the locking mechanisms of the doors. All conveyance, such as boxes and packaging are to be inspected prior to loading. Once loaded, the supplier must inspect the full container including: left side, right side, ceiling or roof, undercarriage and outside doors, hinges and hasps.
- Photographs should be taken for each container to document goods are being loaded dry and that everything is to requirement i.e. no holes, damages or other issues to the container and the goods are loaded to our standards. Additional, photographs of several random cartons should be taken as evidence of the quality of the cartons/goods prior to loading and once loaded.
- Affix working ISO/PAS 17712 seals to all loaded containers. Only designated employees should distribute container seals for integrity purposes.
- Train employees to recognize and report any comprised seals and/or containers immediately and proper notification be made to the Company, US Customs and Border Protection or the appropriate foreign authority.

The Company requires that its suppliers make every effort to:

- ensure a secure supply chain
- provide the Company with security surveys upon request
- make their facilities available for security inspections by the Company or its representatives upon demand

Supplier agrees to take such reasonable measures as may be required by the Company to ensure the physical integrity and security of all shipments to the Company against the unauthorized introduction of harmful or dangerous materials, drugs, contraband, weapons or weapons of mass destruction, or introduction of unauthorized personnel in transportation conveyances or containers.

Such measures may include but are not limited to:

- physical security of manufacturing, packing and shipping areas
- physical examination of the interior and exterior of ocean containers prior to loading
- restrictions on access of unauthorized personnel to such areas
- personnel screening to the maximum limits of law and regulation in supplier's or manufacturer's country
- development, implementation and maintenance of procedures to protect the security and integrity of all shipments.

## 6. **Container/Trailer Damage**

When a container/trailer is offloaded and possible issues with the container, trailer and/or contents, receiving will notify QC who will in-turn conduct an inspection and alert both QC and Receiving Supervisors to the issue. Any damaged goods will be separated and put in a secure location. Once the container is emptied, receiving will conduct a 7-pt inspection together with photos to detail any damages, leaks, holes, etc and share with QC. A final damage count will be conducted and will be written up, submitted to the Supervisors and a claim will be submitted.

**7. Refrigerated Containers**

**Candles**

To maintain the quality of our candle product, Vendors are responsible to ensure temperature sensitive product such as candles are shipped in refrigerated containers. Refrigerated containers will be required for all candle Purchase Orders (Pos) shipping from June to September ex-factory. Outside of this window, it is the vendors responsibility to determine if refrigeration is needed. If the Vendor deems it is necessary, they should get approval from the Asia Merchandise Team.

- A. Vendors should follow normal vessel booking process in accordance with the Vendor Standards Manual (VSM). However, Vendor should mention to forwarders that refrigeration is required at time of booking. (Note: Be aware of container availability - book containers at least 6 weeks prior to handover.)
- i) Vendors should reach out to their assigned expeditor/booking agent (i.e., All Port or Expeditors) to secure their containers prior to handover in accordance with Vendor Support Manual (VSM).
  - ii) Vendors should advise the booking agent what the not to exceed (NTE) temperate of the container should be. For candles, it is recommended container remain between 4° C (40° F) and Max: 30° C (88°F).
  - iii) Vendors should also notify their forwarder that the container should be placed on the sailing vessel in a place that is under the waterline and away from heat/light.
  - iv) AMSCAN will be responsible for the cost of the actual refrigerated container, but vendor may be responsible for covering any additional local fees involved prior to container turn over.
- B. Containers are to be thoroughly inspected by the factory loading the goods to make sure there are no leakages or holes.

**Cosmetics**

The quality of our cosmetic products is of the utmost importance at Party City as cosmetics allows our customer to bring their imagination to life and make memories that last a lifetime. To maintain quality, Suppliers are responsible for ensuring temperature sensitive product such as cosmetics (in addition to existing product already listed in our VSM such as candles) are shipped in refrigerated containers.

**Scope**

Refrigerated containers will be required for all cosmetic (including cosmetic crayons) Purchase Orders (POs) shipping from May to September ex-factory. Outside of this window, it is the vendors responsibility to determine if refrigeration is needed. If suppliers deem refrigerated containers are needed, they should get approval from the Asia Merchandising Team (AMT).

**Process**

- i) Suppliers should follow normal vessel booking process in accordance with the Vendor Support Manual (VSM). However, they should mention to the Freight Forwarder that refrigeration is required at time of booking. (Note: all container availability is a challenge with the global pandemic; to support timely shipments, suppliers must book with Freight Forwarder at least 6 weeks prior to handover.)
  - a. Suppliers should reach out to their assigned Freight Forwarder/booking agent (i.e., All Port or Expeditors) to secure their containers prior to handover in accordance with Vendor Support Manual (VSM).

## Section 7 – Wholesale

- b. Suppliers should advise the Freight forwarder/booking agent recommended container temperature should remain at 20° C (68° F).
    - c. Shipping Orders (SO) to book on a direct service to avoid transshipment ports. When reefer containers are transshipped, carriers won't guarantee if the port will keep them plugged in. Trucks delivering from factories export ports as well as the ones delivering from import ports to Chester, NY must be equipped with operating gensets.
    - d. Suppliers should also notify their forwarder that the container should be placed on the sailing vessel in a place that is under the waterline and away from heat/light.
    - e. AMSCAN will be responsible for the cost of the actual refrigerated container, but vendor may be responsible for covering any additional local fees involved prior to container turn over.
  - ii) Containers are to be thoroughly inspected by the factory loading the goods to make sure there are no leakages or holes.
8. Vendors must strictly adhere to consolidation cut-off times and check with the specified consolidator or carrier's office in advance if a "late gate" is needed. If cargo does not make the designated vessel's departure **or delivers after the PO Ship Date as outlined on the PO issued**, the **PCHI Logistics Team** may **provide** a routing change from the Import team or cancel the PO. All additional freight costs and penalties will be at the vendor's expense. Penalties and reimbursements are defined in the Reimbursement and Waiver Policy, Section 10.
9. All loads must ship from original country of origin.
10. Failure to comply with SOLAS, documentation or marking requirements will result in a deduction of full expenses incurred by PCHI, or our third parties, to meet import requirements.
11. In addition to the labeling requirements outlined in the Packaging and Packing, Section 5b (unless specifically waived by PO), every carton must be clearly marked with the following information (Customs requirements):
  - Country of Origin
  - PO#
  - Model and SKU or Item Number
  - Quantity
  - Weight
12. Cartons with shippable inner quantities must be marked 'Re-Pack' with a bright label. Additionally, each inner carton must have the following information (Customs Requirements):
  - Country of Origin
  - PO#
  - Model and SKU or Item Number
  - Quantity
  - Weight

### FOB Import Document Path

1. Vendors must place booking at least **6 weeks** prior to the required ship date with the PCHI designated Consolidator/Forwarder/Ocean carrier.

Note: Vendors must provide the following information to the designated freight forwarder at the time of booking; otherwise, booking will not be released:

## Section 7 – Wholesale

- Shipper's name
  - Shipper's full address
  - Consignee name
  - Detailed commodities description (no generic description)
  - Harmonized Tariff Number (HTS #)
  - Destination
  - Carton count, quantity in carton, weight, and measurement
  - Country of origin
  - Commercial invoice
  - Final packing list
  - General Certificate of Conformity for Children's Products
2. The Consolidator/Forwarder/Ocean carrier will issue an original Forwarder's Cargo Receipt (FCR) or Express BOL in return for surrender of appropriate documents and cargo. The FCR will NOT be issued unless all required documents are presented.
  3. All original documents and a four-copy set must be surrendered to the consolidator/forwarder at the time the cargo is surrendered or no more than **three (3)** business days after cargo is tendered. Failure to comply will result in reimbursement charges as defined in the Reimbursement and Waiver Policy.
  4. All shipments will be given a Forwarder's Cargo Receipt or an express Bill of Lading unless previously authorized. **PCHI does not accept OBL terms and Vendors must accept HBL terms per directions of our Forwarders.**
  5. VISA documents may not be available at the time of booking due to some countries' export procedures. Proof must be furnished that the quota is available to the shipper at time of booking. However, a document verification certificate or a cargo receipt will NOT be issued until the designated PCHI Logistics Import team verifies the actual VISA documents. It is required the VISA document be supplied prior to the shipment arriving at the first U.S. port of discharge, or costs for storage will be deducted from the shipper's remittance.

### VISA and/or Special Documents Required For Specific Items

In addition to general procedures and documents, some products are subject to special import restrictions, permits, licenses, standards, and/or procedures. To the best of our knowledge, below are the subject products PCHI may be importing:

#### Apparel or items containing textile

- Original VISA stamped document
- Manufacturer's Textile Declaration with authorized signature
- Denim Exclusion Statement for woven cotton garments on manufacturer's stationary with authorized signature
- Down detail statement-for items with down
- Certificate of Origin showing full name and address of the factory
- General Certificate of Conformity
- **For any item containing cotton, please inform local PCHI office of factory location and supply chain compliance with UN International Labor Standards. Third-party verification is required for high risk areas such as Xinjiang Province in China.**

#### Children's Products

- General Certificate of Conformity or Children's Product Certificate (CPC)

## Section 7 – Wholesale

### Art Materials

- General Certificate of Conformity

### Food and Beverage

- Documentation showing compliance with FDA’s Food Safety & Modernization Act, including, but not limited to, third party GMP certification and current FDA registration certificate

### Cosmetics

- Documentation showing compliance with FDA Cosmetic Guidelines, including, but not limited to, third party GMP certification, applicable product test reports, and product inspection documentation

### Composite Wood Products

- Chain of custody documentation which certifies use of compliant raw materials in accordance with the requirements of 40 CFR Part 770 TSCA Title VI and the California Air Resource Board (CARB) Airborne Toxics Control Measure (ATCM). This includes current Factory Certification at time of PO and production and product testing results, both showing compliance for formaldehyde emission.
- Lacey Act/APHIS information must be completed on the Plant and Plant Product Declaration Form
- General Certificate of Conformity

### Footwear

- Interim footwear invoice
- Foxing or Foxing-like band
- Identity material of uppers
- Identify material of sole
- Open or closed shoe
- General Certificate of Conformity

### Citronella Candles

- Lab report certifying that TSCA standard has been met and candle contains 3% or more of citronella content
- Minimum risk pesticide certificate
- General Certificate of Conformity

### Leather items, leather shoes, parts, and finished leather footwear

- Manufacturer’s statement of “PCP” free declaration

### Radio Items

- FCC Form 740

### Eye Wear Products and Sunglasses

Eyewear vendors need to provide the following documents along with the other shipping documents already provided, for example commercial invoice & packing list. Note that two documents (denoted by \*\*\*) are the same for both Sunglasses and Novelty Eyewear:

#### SUNGLASSES - Non-Exempt (Child & Adult) – 3 Documents

- Registration Number of Manufacturer & Device Listing Number of product(s) that are on the Bill of Lading (see RegList.pdf example within Appendix)
- Impact Resistant Drop Ball Test Certification (see IRC-1460.pdf within Appendix) \*\*\*
- Copy of 3<sup>rd</sup> Party Test Report for UV claim and Impact test in accordance with 21 CFR 801.410 and description of sampling plan rationale (Typical test required by Amscan) \*\*\*
- General Certificate of Conformity



## Section 7 – Wholesale

### NOVELTY EYEWEAR - Exempt (Child or Adult; Child item is age graded under 14 yrs) – 3 Documents

- Impact Resistant Drop Ball Test Certification (see IRC-1460.pdf within Appendix) \*\*\*
- Copy of 3<sup>rd</sup> Party Test Report for Impact test in accordance with 21 CFR 801.410 and description of sampling plan rationale (Typical test required by Amscan) \*\*\*
- Photocopy of a picture that clearly shows the *eyewear packaging with the following statement: "⚠ WARNING: These glasses are intended for novelty use only. Not designed to provide medical benefit or protect eyes from impact and UV rays. Please retain this information for future use."*
- General Certificate of Conformity

Identify each photo with the item number that is on the bill of lading.

Please email to [SP.AHI-FDA-IRC@amscan.com](mailto:SP.AHI-FDA-IRC@amscan.com) for each Non-Exempt item and shipment the following documents, as applicable:

- Registration Number of Manufacturer & Device Listing Number of product(s) that are on the Bill of Lading (see RegList.pdf enclosed)
- Impact Resistant Drop Ball Test Certification (see IRC-1460.pdf enclosed)

### **Items made of natural or vegetable material; i.e., bamboo, straw, rattan, grapevine, etc.**

- Certificate of Fumigation
- Lacey Act Declaration
- Items made of wheat or rice straw, cornhusk, seashells, and bones are **not acceptable**
- Wreath products: Items made of bark are not acceptable. Natural wood and grapevine must be stripped of all bark. If there is hesitation to define if the natural material used is to meet compliance, please consult Amscan Compliance Team prior to start of production. Shipments made of non-compliant material are NOT allowed to ship and will incur heavy penalty from Customs detention and confiscation at destination. Vendor is responsible for all fines incurred with non-compliant products.

### **Wreath Products**

- Items made of bark are not acceptable. Natural wood and grapevine must be stripped of all bark. If there is hesitation to define if the natural material used is to meet compliance, please consult Amscan Compliance Team prior to start of production. Shipments made of non-compliant material are NOT allowed to ship and will incur heavy penalty from Customs detention and confiscation at destination. Vendor is responsible for all fines incurred with non-compliant products.

### **Chemical substances; i.e., resins, dyes, glues, ink, paints, etc.**

- TSCA certificate signed by manufacture's shippers stationary with authorized signature
- Lab report certifying TSCA standard has been met

### **Wood packing materials and other unmanufactured wood products; i.e. wood crates are NOT ACCEPTABLE**

- Shipments must certify that no solid wood packing material is present. The certifying statement, "THIS SHIPMENT CONTAINS NO SOLID WOOD PACKING MATERIAL", must be placed on company letterhead and Invoice and/or Bill of Lading.

### **Bamboo products, treated decorative wood items, wood turning planks, etc.**

- Fumigation Certificate or Phytosanitary Certificate
- Wood factory, if audited by CIQ in China and certified with ZMC code, needs to submit valid ZMC certificate prior to shipment. Master cartons should be printed with ZMC code and the code should also show in all shipping documents.

### **Water resistant items**

- AATCC certificate

## Section 7 – Wholesale

### Electric items with plugs

- UL certificate, or equivalent, e.g., ETL or CSA with current listing in United States and Canada
- General Certificate of Conformity

### Foam certificate

- Registration number and certificate of new foam

### Feather Products

- Certificate of Fumigation from export country
- Farm license
- Self-declaration letter
- Veterinary Certificate
- Export Permit or CITES if applicable
- The following information must appear on the commercial invoice or self-declaration letter:
  - Common Name
  - Scientific Name (genus and species)
  - Number of piece
  - Value of the product
  - Country of Origin
  - Source (wild or farm raised)
  - Amscan PO#
  - Amscan Item#
  - Delivery Date

Note: All natural feather products are required by USDA to be sterilized. PCHI conducts random testing for microbial content using USP 61/62 to confirm compliance with USDA requirements.

### Shell Products

- Export Permit or CITES if applicable
- The following information must appear on the commercial invoice or self-declaration letter:
  - Common Name
  - Scientific Name (genus and species)
  - Number of piece
  - Value of the product
  - Country of Origin
  - Source (wild or farm raised)
- Certificate of Fumigation



**Section 7 – Wholesale**

- Prior to booking, CITES must be provided to the Amscan Supply Chain Team located in our Amscan Hong Kong offices. Vendor must have written approval by the Amscan Supply Chain Team in Hong Kong to move forward with booking.

Items containing Peafowl (peacock) feathers are not allowed to deliver without a CITES report. If items get caught by custom at destination without Cites report, items will be confiscated and trashed with all cost incurred in the process to chargeback to vendors.

**PEACOCK, OSTRICH, AND PHEASANT FEATHERS**

The master carton must be marked with the word "Wildlife". Sample label appears below. Failure to include this information on the master carton will result in penalty to the vendor.



- Lacey Act Declaration

## Section 7 – Wholesale

As a result of the Paperwork Reduction Act of 1995, an agency may not conduct or sponsor a collection of information unless it displays a valid OMB control number. The valid OMB control number for this information collection is 0327-0044. The time required to complete this information collection is estimated to average 0.5 hours per response, including the time for reviewing instructions, searching existing data sources, gathering and reviewing the data needed, and completing and reviewing the collection of information. Send comments regarding this burden estimate or any other aspect of this information collection, including suggestions for reducing the burden, to Washington Headquarters Service, Paperwork Project (0327-0044), Washington, DC 20503.

### SECTION 1 - Shipment Information

1. ESTIMATED DATE OF ARRIVAL (MM/DD/YYYY)
2. ENTRY NUMBER
3. CONTAINER NUMBER: <input type="checkbox"/> No Attachment
4. BILL OF LADING
5. NID

### Plant and Plant Product Declaration Form

Section 2: Lacey Act Amendment (16 U.S.C. 3372)



U.S. DEPARTMENT OF AGRICULTURE  
ANIMAL AND PLANT HEALTH INSPECTION SERVICE

6. DESCRIPTION OF MERCHANDISE

7. IMPORTER ADDRESS
8. CONSIGNEE NAME
9. CONSIGNEE ADDRESS

### SECTION 2 - Compliance with Lacey Act Requirements (16 U.S.C. 3372(i))

For each article or component of an article, provide the following:							
1. HTSUS NUMBER (include suffix)	2. ENTERED VALUE	3. ARTICLE COMPONENT OF ARTICLE	4. PLANT SCIENTIFIC NAME (Genus)	5. COUNTRY OF HARVEST	6. QUANTITY OF PLANT MATERIAL	7. UINF	8. POUNDS RECYCLED

Specify under penalty of perjury that, to the best of my knowledge and belief, the information furnished is true and correct.

Version 01-15-2014 0956  
PFD FORM 535  
AUGUST 2011

Signature (Print Name and Title)	Printed Name	Type of Firm	Date
----------------------------------	--------------	--------------	------

Page 1

## Production Control

We require vendors to implement an effective mold prevention plan at the manufacturing facility to reduce the risk of mold development to the products. Moldy products cannot be sold since they are of poor quality and undermine our branding in retails. Most importantly, some types of mold can create health risks in certain individuals. As a result, moldy products will be destroyed at a cost chargeback to vendors. Loss chargebacks will include but are not limited to cost of goods sold, freight, handling and disposal cost, lab fees and loss of sale.

Vendors should always maintain the production facility dry and clean as moisture is the determining factor for mold growth. Any vendors producing items with the use of highly hygroscopic materials as below should stay more vigilant to the production process with best practices to start with material receiving / storage / manufacturing / packaging / finished goods storage and through shipment loading to containers.

- High Risk Items:
  - Wood / MDF
  - Flocked materials, fabric/paper/textile glue laminated products
  - Natural materials (natural rubber/natural down and feathers /real straw)
  - Denim materials treated with washing and bleaching
  - Products containing artificial fibers
  - Real leather or suede / imitation leather / suede in PU
  - **Bubbles**
  - Other items prone to breeding mold

## Section 7 – Wholesale

- Production Check Points:
  - Incoming Material upon receiving
  - Unload materials in a clean and dry area
  - Visually check materials for cleanliness and moisture and use moisture meter to check moisture content
- Material storage:
  - Store materials in a clean, indoor room with the relative humidity below 60%
  - Do not store materials directly on the floor even temporarily
  - Materials must be stored on shelves or non-wooden pallets
- Production:
  - Production areas must be clean and dry with proper ventilation
  - To keep production area free from moisture and contamination, separate the production areas that include water/wet processing (such as painting, electroplating) from other production / packaging and storage areas
- Packaging:
  - Do not pack products when still warm from production
  - Glue and paint must be fully cured and dry prior to packaging, not just dry to the touch
  - Check moisture content of corrugated or cardboard material prior to use
  - Avoid recycled corrugate, which is prone to absorb moisture more than new materials
  - Regardless of corrugate type, moisture content should be between 12% - 13%. Do not use if above 15%
  - Use effective package desiccants with proper dosage to absorb moisture
- Products/Finished goods storage:
  - Maintain a clean dry finished-goods warehouse
  - Control the relative humidity in the warehouse with an air conditioner or dehumidifier
  - Never store finished goods outside, even under a roof or cover
- Loading and Shipping – before loading the container/enclosed truck:
  - Visibly check to ensure the roof is clean and undamaged and there are no holes or cracks in walls, floors or roof. Reject the container if any damage is found
  - Use a moisture meter to check the moisture content of the wooden deck of the container/truck. Reject if the moisture content exceeds 25%
  - Check cargo for visible moisture before loading and pull product randomly to check for the moisture content with a moisture meter
  - Only load in dry conditions or under a roof that does not leak
  - Keep the loading area dry and clean
  - Avoid loading in the rain or fog

### Bill of Lading

Vendors are required to follow the instructions below regarding the proper information for the Bill of Lading:

- 1. Port of Discharge:** East Coast shipments should reflect the unloading port as defined by the PCHI forwarder.
- 2. Place of Delivery:** East Coast shipments should match the final destination on the purchase order.





**Section 7 – Wholesale**

**Packing List**

PCHI requires a packing list as provided in the sample below:

**Packing List**

Page 1 of 1

**Shipper:**  
 JCS Hong Kong Ltd.  
 Room 1108 11/F Mirror Tower  
 61 Mody Road  
 Tsim Sha Tsui East  
 Hong Kong

**Bill To:**  
 Factory Card & Party Outlet  
 2727 Diehl Road  
 Naperville, IL 60563

**Ship To:**  
 Amscan c/o Salson  
 888 Doremus Ave  
 Newark, NJ 08819  
 973-988-0200

**Country of Origin:** China

**Date:** 20090416  
**PL#:** PL-0411-09  
**CI #:** 411088910633151  
**BOL #:** 6910633151

**Container #:** HMMU9000125

**Seal#:** 1238522

Item #	Description	MID #	UOM	Cartons	Units	Weight (kgs)	Cube (cbm)
243292	MASTER CAULDRON ASST 3 FC	CNCALCOS83HON	6	52	312	124.80	5.33
243255	HAND MEAT MARKET FC	CNYUJTOYSHE	3	6	18	9.99	0.11
243090	MASTER RUSTED CAULDRON 1 FC	CNRUIDASHE	3	56	168	126.23	5.26
243254	BRAIN MEAT MARKET FC	CNYUJTOYSHE	3	6	18	12.76	0.25
243256	HRT MEAT MARKET FC	CNYUJTOYSHE	6	6	36	13.07	0.27
243199	REALISTIC FOAM SKULL FC	CNSINCOM158SHE	12	7	84	16.23	1.30
243241	SLIMLINE TOMBSTONE 22IN FC	CNHDKPLA56XIA	18	16	288	233.54	2.33
243242	SLIMLINE SKLL CRSSBN TOMB FC	CNHDKPLA56XIA	9	10	90	8.23	0.86
243244	RIP TMBSTN/SKLTON BAT FC	CNHDKPLA56XIA	9	18	162	12.53	1.54
243298	BRONZE REAPER TOMBSTONE FC	CNHDKPLA56XIA	10	10	100	8.97	0.92
243093	MASTER RUSTED CAULDRON 2 FC	CNRUIDASHE	8	34	272	215.56	4.65
243190	WHT ANGL OF DTH CHST AST FC	CNYUJTOYSHE	6	12	72	11.54	1.15
243249	GRIM REAPER HNG 6FT FC	CNKOL6SHE	12	17	204	197.54	2.05
<b>Totals</b>				<b>250</b>	<b>1824</b>	<b>990.99</b>	<b>26.024</b>

The packing list is a critical item. The list is used by the shipper or forwarding agent to determine the total shipment weight, volume and overall cargo accuracy. Moreover, customs officials (US and foreign) may use the list to review the cargo. Inaccurate or missing information may result in reimbursement charges as defined in the Reimbursement and Waiver Policy, Section 10.



## Section 7 – Wholesale

### Documentation Distribution

Vendor must email a full set of original documents to [chbimport@partycity.com](mailto:chbimport@partycity.com).

Also required is a full set of non-negotiable documents be emailed to our customs house broker as designated by PCHI Logistics Import Team.

Document Origination	Type of Document	To PCHI Designated Company		To Vendor		To Forwarder / Consolidator / Ocean Carrier	
		# of originals	# of copies	# of originals	# of copies	# of originals	# of copies
<b>Forwarder / Consolidator / Ocean Carrier</b>	Express BOL	1	1		1		
	Forwarder Cargo Receipt (FCR)		1	3			
	Container Manifest		1				
<b>Vendor / Shipper Government Documents</b>	Commercial Invoice	1	1			2	1
	Packing & Weight List	1	1			2	1
	Export Permit	1	1			2	1
	Manufacturer's Labor Certificate	1	1			2	1
	Merchandise Testing Report from accepted CPSC lab	1	1			2	1
	GCC, as applicable	1	1			2	1
	CIQ China Inspection and Quarantine	1	1			1	1
	Veterinarian Health Certificate	1	1			1	1
	Drop Ball Test	1	1			1	1
	Impact Resistant Certificate	1	1			1	1
	Lacey Act/APHIS Declaration	1	1			1	1
	Vendor Feather Certificate	1	1			1	1
	Detailed Footwear Invoice/Wearing Apparel Invoice/Textile	1	1			2	1
	FCC Grant of Certification	1	1			2	1
	Country of Origin Certificate (Form A)	1	1			2	1
	Single/Multiple Country Declaration (if Applicable)	1	1			2	1
	No Wooden Pallet Statement	1	1			2	1

All documents must be submitted to the designated PCHI company for payment.

All documents and document distribution must be received on time and accurately or reimbursement charges will apply as defined in the Reimbursement and Waiver Policy, Section 10.



## Section 7 – Wholesale

### Delivered Duty Paid (DDP)

For a DDP shipment, Vendors are responsible for delivery to the PCHI DC door, including all freight costs, duties, and customs clearance under the Vendor's own importer of record number.

PCHI requires all DDP shipment to be routed as "Pre-Paid PCHI location". All freight, duty, and drayage should be prepaid and any demurrage is the responsibility of the Vendor.

All DDP shipments delivered to PCHI require a delivery appointment. Vendors must have a delivery appointment prior to delivery, (see routing instructions for making appointments with the DC's). It is the vendor's responsibility to calculate and manage all free days on all DDP containers. The designated drayage agent is up to the discretion of the vendor.

### Amscan Distribution Center

#### East Coast DC (ECD):

Amscan  
47 Elizabeth Dr  
Chester, NY 10918

Tel: 845-469-9116  
Fax: 845-469-5140  
Keith Knoell Ext 2703 or Margaret Ferris Ext 2701

### Anagram International Distribution Center:

#### Midwest DC (Edina DC):

Anagram International  
5300 West 76<sup>th</sup> Street  
Edina, MN 55439

Tel: 952-949-5854  
Fax: 952-835-3094  
Adrian Peers: 952-949-5647

Vendors are responsible for all containers, including the pick-up of empty containers whether a return delivery is made or not. Containers MUST be picked up within 24 hours of PCHI fax notification.

If for some reason you cannot comply with these requirements, contact the PCHI Logistics team immediately to avoid reimbursement charges.

### Landed Duty Paid Deliveries (LDP)

For an LDP shipment, Vendors are responsible for delivery to the port of entry determined by the PCHI Logistics Import team, including all freight costs and customs clearance under the vendor's own importer of record number. PCHI take possession of the goods after they have cleared customs.

PCHI prefers DDP shipments to LDP shipments. If PCHI issues a LDP order, the vendor must:

- Notify the designated PCHI Import team at least five business days prior to container arrival at the port of entry.

Vendors must contact the designated PCHI Logistics Import team to determine the port of entry.



## Section 7 – Wholesale

Vendors are responsible for any freight charges if PCHI port selection is not followed or failure to obtain approval of delivery port.

Failure to comply may result in chargebacks for demurrage, additional freight charges or other issues as defined in the Reimbursement and Waiver Policy, Section 10.

### For Anagram International contact:

PCHI Logistics Team - Imports		
Adrian Peers	<a href="mailto:apeers@anagramintl.com">apeers@anagramintl.com</a>	952-949-5647

### For ALL other contact:

PCHI Logistics Team - Imports		
<a href="mailto:bdzinski@partycity.com">Bruce Dzinski</a>	<a href="mailto:bdzinski@partycity.com">bdzinski@partycity.com</a>	
<a href="mailto:pnikolov@partycity.com">Pavlin Nikolov</a>	<a href="mailto:pnikolov@partycity.com">pnikolov@partycity.com</a>	

## FOB Vendor Payment

### Check/Wire Transfer

For all import POs (FOB/DDP/LDP), the **Sourcing Team** determines vendor payment terms and forwards all required payment request forms to the following:

Anagram International fax to 952-949-5609 Attn: Accounts Payable  
 For ALL other fax to 914-345-8684/8685 Attn: [elmaccpay@amscan.com](mailto:elmaccpay@amscan.com)

The following is a wire transfer example:

#### SAMPLE Wire Transfer Instructions

Please provide all requisite Beneficiary information

From: China Supply and Consolidations Ltd.

RE: Banking Information

Beneficiary Name	China Supply and Consolidations Ltd.
Beneficiary Address in Full	99/L, CommMutual Tower, 32, Worchester Road Wanchai, Hong Kong
Beneficiary Account Number	527-0-123456-3 (USD)
Beneficiary Bank Location	Hong Kong
Beneficiary Bank Name	Hong Kong Peoples Bank (Hong Kong) Ltd.
Beneficiary Bank Address in Full	99 Dos Roeuk Road Branch 99 Dos Roeuk Road Central Hong Kong
Beneficiary Bank ID (Swift Address)	HKAMHKHH



## Section 7 – Wholesale

### Exports

#### Overview

PCHI has locations worldwide and for items destined to these locations, we seek to follow all international trade guidelines. Due to these regulations and documentation requirements, Amscan encourages vendors to read and follow instructions thoroughly. Please note, shipping guidelines are generalized and may vary with each vendor, destination, or PO. Contact the Amscan Logistics team with any questions. We appreciate your cooperation in complying with the standards established for Amscan's Import program.

#### Distribution / Wholesale Locations

For vendors shipping from the US to a PO address in a foreign country, the following documentation will be required.

- Commercial Invoice
- Packing list
- Bill of Lading
- Certificate of Origin
- NAFTA Certificate for items made in the US shipped to Canada or Mexico

#### Commercial Invoice

The Commercial Invoice must include the following:

- Detailed commodities description
- Harmonized Tariff Number (HTS#)
- Factory Address FOR EACH ITEM
- Master carton quantity, cost, and piece count
- Item number

#### Packing List

The packing list is a critical item. The list is used by the shipper or forwarding agent to determine the total shipment weight, volume and overall cargo accuracy. Moreover, customs officials (US and foreign) may use the list to review the cargo. Inaccurate or missing information may result in reimbursement charges as defined in the Reimbursement and Waiver Policy, Section 10.

The packing list must include the following:

- Individual net, legal tare and gross weights
- Total weight of all packages
- Measurements for each package
- Package markings with the shipper and item #
- Total quantity of packages
- General description of goods
- SKU number, item number and quantity of each
- Item number



## Section 7 – Wholesale

### Bill of Lading

- Destination
- Carton Count
- Seal Number
- Other standard requirements

### Shipping

Containers must meet Cubic Meter (CBM) minimum requirements. All LCL shipments require written approval from the Amscan Logistics Import team. Vendors are financially responsible for under-utilized containers based on minimum CBM requirements as listed below.

Container	Cubic Meter
20 (TEU)	28 CBM
40 (FEU)	58 CBM
40H (FEU)	65 CBM
45 (FEU)	68 CBM
48 (FEU)	72 CBM

Delivery to CFS (Consolidated Freight Station or EDC)

Delivery of freight is the responsibility of the vendor. All freight must be cleared by (country of origin) Customs prior to ship date. For visibility purposes, whenever possible, bookings (for delivery to CFS) shall be made on-line.

Vendor Booking Procedures with CFS (unless otherwise noted by CFS instructions):

- Vendor must fax or email all details / PO information to CFS Origin office using CFS Shipping Order Form.
- All bookings must be submitted to the CFS origin no later than 7 days prior to cargo ready date.
- Approval is required from CFS. Shipping order can be released by CFS to vendor for cargo delivery within 24 hours upon receipt of completed booking.
- Only one shipping order per delivery to CFS.
- Daily booking cutoff time is 15:00 (3:00 PM); if the booking is received after 15:00, it will be processed the next working day.
- The Shipper Name shown on shipping order is the Shipper Name shown on FCR.
- Once the shipping order is released, any amendment to the shipping order must be communicated to CFS origin office for validation.
- If the Vendor declares "no wood packing material", the vendor must include this statement on the shipping order, or by submitting a "no wood packing material declaration" on their company letterhead to CFS origin.

CFS Cargo Receiving Procedure, unless otherwise noted by CFS instructions:

- CFS will advise the closing date on the shipping order.
- Origin Warehouse will check the condition and quantity of the cartons. The following conditions are not allowed without consignee's consent:
  - Wet cartons
  - Damaged cartons
  - Carton marking by paper label
- Vendor must deliver cargo by Shipping Order, by item number, by manufacturer style number (if not, a sorting charge will be incurred).
- Vendor needs to notify CFS of partial delivery. All partial shipments must be delivered within three days of first delivery date.
- For late cargo delivery, vendors must obtain approval from CFS. Notification methods may vary by CFS.



## Section 7 – Wholesale

Vendors must strictly adhere to consolidation cut-off times and check with the specified consolidator/forwarder. If cargo does not make the designated vessel's departure and is outside of the **required** PO ship **date**, the PCHI Logistics Team may provide a routing change from the Import team or cancel the PO. All additional freight costs and penalties will be at the vendor's expense. Penalties and reimbursements are defined in the Reimbursement and Waiver Policy.

Failure to comply with marking requirements will result in a deduction of full expenses incurred by Amscan, or our third parties, to meet import requirements.

In addition to the labeling requirements outlined in Packaging and Packing Instructions, Section **5b** (unless specifically waived by PO), every carton must be clearly marked with the following information

- Country of Origin
- PO#
- Model and SKU or Item Number
- Quantity

Cartons with shippable inner quantities must be marked 'Re-Pack' with a bright label. Additionally, each inner carton must have the following information for Customs requirements:

- Country of Origin
- PO#
- Model and SKU or Item Number
- Quantity

Vendors must place booking at least **6 weeks in advance** prior to the required ship date with the Amscan designated Consolidator/Forwarder/Ocean carrier.

Note: Vendors must provide the following information to the designated freight forwarder at the time of booking; otherwise booking will not be released:

- Shipper's name
- Shipper's full address
- Consignee name
- Detailed commodities description (no generic description)
- Harmonized Tariff Number (HTS #) and category
- Destination
- Carton count, quantity in carton, weight, and measurement
- Country of origin
- Final packing list

**Documentation Distribution**

Document Origination	Type of Document	To Amscan		To Vendor		To Forwarder / Consolidator / Ocean Carrier	
		# of originals	# of copies	# of originals	# of copies	# of originals	# of copies
<b>Forwarder / Consolidator / Ocean Carrier</b>	Express BOL	1	1		1		
	Forwarder Cargo Receipt (FCR)		1	3			
	Container Manifest		1				
<b>Vendor / Shipper Government Documents</b>	Commercial Invoice	1	1			2	1
	Packing & Weight List	1	1			2	1
	NAFTA Certificate (if applicable)	1	1			1	1
	Veterinarian Health Certificate (if applicable)	1	1			1	1
	Vendor Feather Certificate	1	1			2	1
	Detailed Footwear Invoice/Wearing Apparel Invoice/Textile	1	1			2	1
	FCC Grant of Certification	1	1			2	1
	Country of Origin Certificate (Form A)	1	1			2	1
	Single/Multiple Country Declaration (if Applicable)	1	1			2	1
	No Wooden Pallet Statement	1	1			2	1

All documents must be submitted to Amscan for payment.

All documents and document distribution must be received on time and accurately or reimbursement charges will apply as defined in the Reimbursement and Waiver Policy.

**Product Regulatory Compliance**

It is PCHI’s policy that products meet all applicable standards and regulations for the markets in which the products are sold. For example, Toys sold in Europe would need a CE mark and evidence that the item is in compliance with the Toy Safety Directive and testing specified in EN 71 and other applicable standards. Items sold in Australia or other countries need to meet applicable standards for that country. Please contact your local PCHI representative regarding product testing requirements for International markets.

**Other Documentation**

In addition to general procedures and documents, some products are subject to special export restrictions, permits, licenses, standards, and/or procedures. Vendor needs to provide all applicable documents for export and import to the destination country listed on the PO to the forwarder at the time cargo receipt. Any delays will result in a chargeback fee or penalty as outlined in the Reimbursement and Waiver Policy, Section 10.



## Section 7 – Wholesale

### Product Invoicing

Invoices are to be submitted to the address of the receiving locations Headquarters or as listed on the PO. Product must be invoiced one PO# per invoice. Invoice is to be submitted in Master cases with the master case cost:

### Contact information:

Logistics - Exports		
Lisa Basso	<a href="mailto:lbasso@amscan.com">lbasso@amscan.com</a>	914-784-4079
Export Compliance	<a href="mailto:CHBimport@partycity.com">CHBimport@partycity.com</a>	





# HALLOWEEN CITY

## Section – 8a,b,c (Retail & Wholesale)

### Transportation Routing Guide (TRG)

#### Party City/Amscan Transportation Routing Guide (TRG)

- TRG provides information for Parcel, LTL, and TL shipments to retail and wholesale locations.
- TRG may change from periodically; It is the Vendor’s responsibility to check for VSM and TRG updates to avoid chargebacks listed in the Reimbursement and Waiver Policy, Section 10.

#### Party City/Amscan Shipment Restrictions by Transportation Mode:

Shipment Type	Carrier	Service Level	Max Length	Min Weight	Max Weight	Max Length + Girth (see calculation**)	Max # Packages	Max Pallets
Single Package Parcel	UPS required for Collect and Third Party Shipments; UPS preferred for Prepaid Shipments	Ground	96"		70 lbs.	130"		
Multi-package Parcel	UPS required for Collect and Third Party Shipments; UPS preferred for Prepaid Shipments	Ground			500 lbs.		40	
Air/Express Parcel*	UPS required for Collect and Third Party Shipments; UPS preferred for Prepaid Shipments	NDA Saver			40 lbs/pkg or 400 lbs/shipment		10	
LTL	Carrier Stated on BOL for Collect Shipments; Consult list of Party City Preferred Carriers for Prepaid Shipments			500 lbs.	10000 lbs.			8 standard pallets
TL	Carrier Stated on BOL for Collect Shipments; Prepaid Shipments have carriage set by Vendor			>5000 lbs	40000 lbs.			

#### Parcel:

- UPS Ground **must** be used for all Collect and Third-Party Parcel Shipments.
- UPS Ground is **preferred** for all Prepaid Parcel Shipments.



# HALLOWEEN CITY

## Section – 8a,b,c (Retail & Wholesale)

Parcel Shipment Requirements are outlined in chart below:

PARCEL SHIPMENT REQUIREMENTS					
Terms (found on VPA)	Carrier/Service Level	Bill To Shipper Number	Billing Address	Shipping Automation	Parcel Documentation Requirements (found on the EDI 850 sent by Party City to Vendor)
Prepaid	UPS Ground preferred; Vendor selects since paying freight charges	N/A	N/A	Required*	<ul style="list-style-type: none"> <li>•Ref1: Must contain "PO Number" (total of 14 digits); Example 4 digits followed by a "-" and then 9 digits: 0001-123456789</li> <li>•Ref2: Must contain "Carton ID / ASN Number / UCC128" (total of 20 digits); Example 20 digits: 00000092003139712890</li> <li>•Ref3: "Invoice Number" - max of 20 digits (if available at time of shipment)</li> </ul>
Collect	UPS Ground Required	Located on S2B2 File	Located on S2B2 File	Required*	<ul style="list-style-type: none"> <li>•Ref1: Must contain "PO Number" (total of 14 digits); Example 4 digits followed by a "-" and then 9 digits: 0001-123456789</li> <li>•Ref2: Must contain "Carton ID / ASN Number / UCC128" (total of 20 digits); Example 20 digits: 00000092003139712890</li> <li>•Ref3: "Invoice Number" - max of 20 digits (if available at time of shipment)</li> </ul>
Third Party	UPS Ground Required	Located on S2B2 File	Located on S2B2 File	Required*	<ul style="list-style-type: none"> <li>•Ref1: Must contain "PO Number" (total of 14 digits); Example 4 digits followed by a "-" and then 9 digits: 0001-123456789</li> <li>•Ref2: Must contain "Carton ID / ASN Number / UCC128" (total of 20 digits); Example 20 digits: 00000092003139712890</li> <li>•Ref3: "Invoice Number" - max of 20 digits (if available at time of shipment)</li> </ul>

\*Shipping Automation info is located at [www.ups.com](http://www.ups.com); UPS World Ship or any approved vendor manifest system can be used.

### LTL and TL:

- **Collect or Third-Party Vendors:**
  - LTL/TL **must** be booked in E2Open TMS System
  - For E2Open portal access or questions, email [partycity.transportation@genpact.com](mailto:partycity.transportation@genpact.com)
  - For LTL/TL questions, email [partycity.transportation@genpact.com](mailto:partycity.transportation@genpact.com)
  - Collect billing address for Corporate Stores or Corporate paid roll-out:

**Amscan Party City**  
 c/o TranzAct Technologies  
 360 West Butterfield Road Suite 400  
 Elmhurst, IL 60126



## HALLOWEEN CITY

### Section – 8a,b,c (Retail & Wholesale)

***(A hard copy of the BOL must accompany the invoice; failure to do so will result in a rejected bill)***

- For DC shipments, Vendor must email the packing list and BOL no later than actual pick-up to the following based upon destination:
  - Chester DC: Email the following: Jean Zaccagnino [zaccagnino@amscan.com](mailto:zaccagnino@amscan.com), Karen Knecht [kknecht@amscan.com](mailto:kknecht@amscan.com), Lisa Basso [lbasso@amscan.com](mailto:lbasso@amscan.com)
  - Naperville (Party City.com) DC: Agnes Wujda, email [awujda@amscan.com](mailto:awujda@amscan.com)
  - Halloween City DC: Steve O'Toole, email [sotoole@halloweencity.com](mailto:sotoole@halloweencity.com)
  - Anagram International: Adrian Peers, email [apeers@anagramintl.com](mailto:apeers@anagramintl.com)
- Failure to adhere to the requirements above may result in vendor chargebacks as defined in Reimbursement and Waiver Policy, Section 10.
- **Prepaid Vendors:**
  - Access to E2Open is not needed.
  - For all LTL shipments, use of one of the below Preferred Carriers is expected:
    - YRC/New Penn: [Platinum.Support@YRCFreight.com](mailto:Platinum.Support@YRCFreight.com)
    - TForce: [partycitysupport@tforcefreight.com](mailto:partycitysupport@tforcefreight.com)
  - LTL BOL Requirements:
    - PO number for each PO in shipment
    - Total carton and pallet count for shipment
    - Total shipment weight
    - NMFC freight class for each item on PO
    - Address & Telephone for shipping location
    - Address & Telephone for receiving location and Store # (if retail)
    - Freight term - PPD
    - Pick-up date/Ship date (date shipment leaves vendor dock)
    - Carrier Name
    - Carrier PRO or tracking number
    - The following verbiage:
      - ✓ "Liftgate Required (if retail/store delivery)"
      - ✓ "Appointment required for delivery"
      - ✓ "Call for appointment" (Store telephone number located in S2B2 file)
      - ✓ "Sign for Carton Count"
  - Prepaid Vendors are responsible for all accessorial charges associated with their shipments.
  - It is the vendor or vendor's carrier responsibility to secure a delivery appointment for DC destined shipments:
    - Chester DC Scheduling: 845-469-9116
    - Naperville (Party City.com) DC Scheduling: 630-579-2067
    - Halloween City DC Scheduling: 734-679-4947
    - Anagram International Scheduling: 952-949-5865



## HALLOWEEN CITY®

### Section – 8a,b,c (Retail & Wholesale)

- For DC shipments, Vendor must email packing list and BOL no later than actual pick-up to the following based upon destination:
  - Chester DC: Email the following...Jean Zaccagnino [zaccagnino@amscan.com](mailto:zaccagnino@amscan.com), Karen Knecht [kknecht@amscan.com](mailto:kknecht@amscan.com), Lisa Basso [lbasso@amscan.com](mailto:lbasso@amscan.com).
  - Naperville (Party City.com) DC: Agnes Wujda, email [awujda@amscan.com](mailto:awujda@amscan.com)
  - Halloween City DC: Steve O'Toole, email [sotoole@halloweencity.com](mailto:sotoole@halloweencity.com)
  - Anagram International: Adrian Peers, email [apeers@anagramintl.com](mailto:apeers@anagramintl.com)
  
- For LTL/TL questions, email [partycity.transportation@genpact.com](mailto:partycity.transportation@genpact.com)
  
- Failure to adhere to the requirements above may result in vendor chargebacks as defined in Reimbursement and Waiver Policy (Refer to Section 10).

**Section – 9a,c (Retail)****Accounts Payable****Overview – Party City (includes Party City, Party America, and Halloween City)**

This section outlines important information for invoice requirements and processing policies. Accurate information will ensure timely processing of payments.

Direction for the processing of independent franchise orders, shipments and invoices will be given by the management of the individual franchise stores. You will be notified in advance if there are any changes to this process for any store or store group.

**Invoice Requirements**

Party City requires all merchandise vendors to submit invoices electronically (EDI 810) unless approved, in writing, for manual invoice submissions. (See EDI invoice requirements in EDI, Section 4. If you are not able to send invoices electronically, please contact Alissa Barrett, Accounts Payable Manager, to avoid non compliance charges and to determine actions required to become EDI compliant). All invoices submitted for processing must be submitted in the Vendor's currency and in turn will be remitted in the invoice currency.

**ASN (Advanced Shipping Notice) Data**

In addition, vendors are required to transmit ASN data electronically (EDI 856). (See EDI requirements in EDI, Section 4.) ASN data is a key component of the store receiving process and invoices can not be paid if ASN data is not provided. **Failure to provide ASN data within 24 hours of shipment will result in a charge of \$25 per shipment and \$5.00 per carton.**

**Purchase Order and Invoice Data Relationship and Requirements**

After a valid PO (EDI 850) is received from Party City, follow these procedures to ensure your invoices are paid on a timely basis:

1. Verify the accuracy of all PO details including unit cost\*, payment terms, minimum order quantities, etc. Do not ship merchandise until all discrepancies on the PO have been corrected and the Category Manager or the P&A Manager provides proof of correction to you in the form of a new PO.

**\*The unit cost on the invoice must not exceed the unit cost on the PO. Party City will not recognize any vendor price increase effective after the date of a PO. If a PO is accepted and the order is filled, the unit cost on the PO will be the basis of the liability for units received, not in excess of the order quantity.**

***Telephone orders, and verbal commitments will not be considered binding.***

2. Vendors are required to create one invoice per PO, per shipment, per shipping point and per "ship to" point. In other words, one invoice per PO delivery from one vendor location to one retail customer location. You may have multiple invoices per PO, but you may not combine multiple POs on one invoice.

**Section – 9a,c (Retail)**

The following information must be included on the EDI invoice:

- The complete PO number, in its exact format with no changes (Do not combine PO numbers and/or locations on the same invoice).
- Your company or division name, as well as your Party City vendor number
- Your unique invoice number and invoice date (which must not be prior to the actual date the merchandise was shipped). There must be a unique invoice for each location and PO number.

**Invoice numbers MUST NOT be reused. (See EDI invoice requirements in Section 4, EDI).**

- Terms of the sale for the invoice (must be the same terms as provided on the PO)
- Ship to address and store number
- The item number along with a detailed item description
- The unit quantity shipped, unit cost and extended cost for each item (must be in eaches, not cases)
- The reference (Ref Si) that links the invoice to the shipment (same number provided on the ASN document) (see section 4 for more detail)
- Shippers PRO bill number, LCC number, or other tracking number to be used in obtaining Proof of Delivery
- Line item details, when totaled, must agree to header record of EDI invoice to the penny. If there is a discrepancy, we will pay the total of the line items.
- Off invoice allowances and charges must be provided as separate line items and must be coded using Party City approved codes only. (See page 4 for listing of valid codes. If a new code is needed to support a different charge or allowance type, please contact Alissa Barrett, Accounts Payable Manager)
- All invoices must be sent within 24 hours of shipment of goods.

Manual Invoices (If approved means of submission)

If manual invoices must be sent, all off-invoice allowances and charges not reflected on a Party City PO (included in the net cost) must be individually identified at summary level. Provide a net total dollar (in the correct vendor currency) of all allowances on the last page. Do not include allowances within the line item detail (as per example). This applies to manual invoices only. Each charge and allowance type must appear as a separate line on the invoice.

EXAMPLE				
Item	Description	Units	Cost	Extended Cost
12345	Party Goods	12	2.95	\$ 35.40
23456	Party Supplies	24	1.15	\$ 27.60
	Merchandise Total			\$ 63.00
	Allowances – specific			\$ (6.30)
	Other Charges – specific			\$ 9.95
	Total Invoice Amount			\$ 66.65

**The invoice number MUST appear on each page of a hard copy multi-page invoice.**

**Section – 9a,c (Retail)**

Provide a bill of lading with the invoice, or list the following on the invoice:

- Number of cases shipped
- Carrier Name
- Carrier's PRO/LCC number or BOL #
- Freight terms (FOB Destination, Collect, Vendor Truck, or Customer Pickup)

Send all manual invoices and billing related documents for Party City and Halloween City Corporate Stores to:

Party City Corporation  
Attn: Merchandise Payables  
Vendor ID# \_\_\_\_\_  
25 Green Pond Rd Suite 1  
Rockaway, NJ 07866

**Invoice Processing Policies**

Unless other agreements are made, deductions will be taken from invoices with quantity variances caused by shipment/picking errors, concealed shortages, carton shortages, concealed damages and overshipments. In addition, discrepancies in pricing will also create a deduction, if the invoiced cost is higher than the PO cost. These deductions will be identified on the remittance advice. The reference will be the original invoice number followed by "DM", identifying this as a debit memo.

The invoice due date will be based on receipt of goods and upon the most favorable of the invoice, PO or VPA terms. The system will age invoices based on the PO terms, so it is important that the correct PO terms are on the purchase order.

Cash discounts and allowances will be calculated based on the gross amount of the invoiced merchandise and based upon the most favorable of the invoice, PO or VPA terms.

Party City reserves the right to deduct, from vendor payable balances, amounts for allowances, rebates, bill backs, returns, non-compliance charges, post audit claims and other receivables. Where balances cannot be collected timely, Party City reserves the right to request payment by check on balances due.

**Remittance Advice**

The corporate office in Rockaway will issue a single corporate check for Party City Corporate and Halloween City approved invoices.

The following information will be provided on the check and remittance advice:

- Vendor Number
- Vendor and/or Factor name
- Vendor/Factor remittance address
- Check number
- Check date
- Invoice number
- Invoice date
- PO number
- Cash Discount
- Net amount of invoice

**Section – 9a,c (Retail)**

Remittance Example:

<b>PARTY CITY CORPORATION</b>				<b>No. 43125</b>	
Date: 27-OCT-03		Vendor Name: ABC COMPANY		Vendor No. 123	
<u>Invoice Number</u>	<u>Invoice Date</u>	<u>Description</u>	<u>Gross Amt</u>	<u>Discount</u>	<u>Net Amount</u>
DC26336	30-SEP-03	538-99567	180.00	1.80	178.20
DC26338	30-SEP-03	528-88565	150.00	1.20	148.80
DC26338DM	30-SEP-03	518-33943	(120.00)		(120.00)
			<hr/>		
			210.00	3.00	207.00

**Vendor Inquiries & Correspondence**

Vendor inquiries regarding A/P transactions, balances and discrepancies must be directed to:

Party City Corporation  
 Attn: Merchandise Payables  
 Vendor ID# \_\_\_\_\_  
 25 Green Pond Rd Suite 1  
 Rockaway, NJ 07866

Vendors must state the situation in writing, attach supporting documentation to their written inquiry and send the package to Party City’s A/P Department at the address referenced above. **All correspondence must include your vendor number.** Allow 2 to 4 weeks for a response.

Vendors may send inquiries via email to [accountspayable@partycity.com](mailto:accountspayable@partycity.com)  
 The Accounts Payable group phone number is (973) 453 – 8736.  
 The group fax number is (973) 983 – 4988.

Inquiries will be processed in the order received.

**Changes to Vendor Information**

Documentation on company letterhead must be emailed or faxed and signed by a senior officer of your company. All changes must be received 14 days prior to the effective date. Changes would include, but not limited to:

- Change in remittance address
- Change in Company Name
- Change in ownership: If a change in ownership occurs and the new owner is not currently in our vendor file as an authorized vendor, the company will be considered a new vendor and will be required to complete all the documents required of a new vendor.
- Change in legal structure
- Bankruptcy filings
- Change in "Return to Vendor" address
- Change in Shipping locations



## Section – 9a,c (Retail)

The letter communicating changes must contain the following information:

- Your company name and Party City vendor number
- Statement of the change being communicated
- Signature of a senior officer (if mailed or faxed). If communication is emailed, it needs to be emailed from the senior officer.

The mailing address for changes is:

Party City Corporation  
Attn: Merchandise Payables  
Vendor ID# \_\_\_\_\_  
25 Green Pond Rd Suite 1  
Rockaway, NJ 07866

### Post Audit Policy

Party City may conduct Post Audits of all merchandise transactions. Party City reserves the right to file claims within 48 months of the event. Party City's auditors will submit all claims in writing and allow vendor 30 days to review and respond to the claims before any deduction is taken for those transactions that are more than 12 months old. Claims for transactions less than 12 months old will be deducted as discovered.

### Overages

Party City, as a matter of policy, does not condone the shipment of overages. Overages will be processed. The vendor may be charged for the cost of processing the overage, a deduction for the cost of the goods, plus an administration fee as listed in the Reimbursement and Waiver Policy, Section 10.

Party City does not acknowledge any changes, which causes an overage if they are not communicated via a new PO. No handwritten notes, verbal, phone or faxed agreements will be accepted.

Party City reserves the right to return product at vendor's expense in addition to any expenses incurred for inbound freight, and/or administrative charges if terms are Freight Collect-FOB Destination.

### Statement of Account

All vendors are required to send a complete statement of account of all open items, including all open invoices and credits to the Merchandise Payables department on a monthly basis. If the statement of account shows a Zero balance, still send this statement reflecting this for our records.

The preferred method of receiving the statement is as follows:

1. Email an Excel or text electronic file of statement to [statements@partycity.com](mailto:statements@partycity.com)  
(You do not need to cc anyone)
2. Fax to: 973-983-4988 Attn: Merchandise Payables
3. Mail to: Party City Corporation  
Attn: Merchandise Payables  
25 Green Pond Rd Suite 1  
Rockaway, NJ 07866

**Section – 9a,c (Retail)**

**EDI Invoice codes to use in the SAC segment for charges and allowances:**

CODE	ALLOWANCE DESCRIPTION
A170	ALLOWANCE ADJUSTMENTS
A260	ADVERTISING ALLOWANCE (I.E. AD DISCOUNT)
A400	ALLOWANCE NON PERFORMANCE
B800	BOTTLE DEPOSIT RETURN
B950	DAMAGED MERCHANDISE
C000	NO RETURN CREDIT ALLOWANCE
C300	INV LOSS VENDOR DAMAGE CREDIT
C310	DISCOUNT
E730	NEW ITEM
E740	NEW STORE
E750	NEW STORE DISCOUNT
E760	NEW WAREHOUSE DISCOUNT
F800	PROMOTIONAL ALLOWANCE
F810	OTHER DISCOUNTS/ALLOWANCES
F970	REBATE
G860	SHRINK ALLOWANCE (CLR)
H000	SPECIAL ALLOWANCE (MARKDOWN ALLOWANCE)
I530	VOLUME

CODE	CHARGE DESCRIPTION
A250	ADVANCES (PREPAYMENT)
B240	COD Charges
C090	SHELL DEPOSIT - BEVERAGE
C110	BOTTLE DEPOSIT - BEVERAGE
C420	DRAYAGE
C440	DRIVER ASSISTED UNLOADING
C640	ENERGY CHARGE
D240	FREIGHT
D270	FUEL SURCHARGE
D500	HANDLING (UNDER MINIMUM ORDER)
D820	INSIDE DELIVERY
D920	INSURANCE FEE (FREIGHT INSURANCE)
F730	(OVERNIGHT) PRIORITY SERVICE (I.E. 2ND DAY AIR)
G160	REDELIVERY
G240	REFUND
G470	RESTOCKING CHARGE (OVER ORDER)
H090	SPECIAL CHARGE (VENDOR CHARGE)
H400	STOPCHARGE
H600	TANK RENTAL
H625	CALIFORNIA BEVERAGE TAX
H700	CHICAGO WATER TAX
H701	ARKANSAS SALES TAX
H702	WEST VIRGINIA SALES TAX
H730	TAX
H750	LOUISIANA TAX
I500	VENDOR FREIGHT



## Section – 9b (Wholesale)

### Accounts Payable

#### Overview

This section outlines the general guidelines for PCHI (Party City Holdings Inc) Wholesale consisting of Amscan and Anagram International unless stated otherwise. The guidelines included in this section are for invoice requirements and processing policies. Accurate information will ensure timely processing of payments.

#### Invoice Requirements

PCHI requires all merchandise vendors to submit paper invoices.

After a valid Purchase Order (PO) is received from PCHI, follow these procedures to ensure your invoices are paid on a timely basis:

Verify the accuracy of all PO details including **Master** unit cost, payment terms, minimum order quantities, etc. Do not ship merchandise until all discrepancies on the PO have been corrected and the Inventory Manager provides proof of correction to you in the form of an email notification or a new PO.

*Telephone orders, and verbal commitments will not be considered binding.*

#### Domestic Vendors – Freight Collect

Domestic Vendors are required to create one invoice per PO, per shipment, per shipping point and per "ship to" point. Invoices are not to be sent prior to shipping. **When a vendor is ready to ship, they must contact [Partycity.transportation@genpact.com](mailto:Partycity.transportation@genpact.com) and [@Transportation, PartyCityDocs](#) to arrange booking details and documents. For any escalation points, vendors can contact Inbound/Outbound transportation managers.**

**All shipping documents should be shared with [@Transportation, PartyCityDocs](#) as drivers must have paper copies of same documents for the DC: Packing List and B/L are a must.**

**Invoices with supporting documents such as B/L and packing list must be shared with [@Transportation, PartyCityDocs](#) and Tranzact – invoices must go through PartyCityDocs and Tranzact emails for verification of costs and processing to AP upon approval ([@Transportation, PartyCityDocs](#) can assist with the onboarding of vendors in TZ). PartyCityDoc team is also the one to handle any manual resolutions for invoices that don't go thru TZ.**

The following information must be included on the invoice:

- The complete PO number, in its exact format with no changes (Do not combine PO numbers and/or locations on the same invoice).
- Company or division name
- Unique invoice number and invoice date (which must not be prior to the actual date the merchandise was shipped). There must be a unique invoice for each location and PO number.

**The invoice number MUST appear on each page of a hard copy multi-page invoice. Invoice numbers MUST NOT be reused.**



## Section – 9b (Wholesale)

- The terms of the sale for the invoice must be clearly indicated
- Remit-to address
- Ship to address
- PCHI item number along with a detailed item description
- The Master Carton (MC) quantity shipped, MC unit cost and extended cost for each item
- Gross cost summation

Domestic Vendors are required to provide a bill of lading with the invoice, or list the following on the invoice:

- Number of cases shipped
- Carrier Name
- Carrier's PRO/LCC number or BOL # or other tracking number to be used in obtaining proof of delivery
- Freight terms (FOB Destination, Collect, Vendor Truck, or Customer Pickup)

### Domestic Vendors – Freight Prepaid

The following information must be included on the invoice:

- The complete PO number, in its exact format with no changes (Do not combine PO numbers and/or locations on the same invoice).
- Company or division name
- Unique invoice number and invoice date (which must not be prior to the actual date the merchandise was shipped). There must be a unique invoice for each location and PO number.

**The invoice number MUST appear on each page of a hard copy multi-page invoice. Invoice numbers MUST NOT be reused.**

- The terms of the sale for the invoice must be clearly indicated
- Remit-to address
- Ship to address
- PCHI item number along with a detailed item description
- The Master Carton (MC) quantity shipped, MC unit cost and extended cost for each item
- Gross cost summation

Domestic Vendors are required to provide a bill of lading with the invoice, or list the following on the invoice:

- Number of cases shipped
- Carrier Name
- Carrier's PRO/LCC number or BOL # or other tracking number to be used in obtaining proof of delivery
- Freight terms (FOB Destination, Collect, Vendor Truck, or Customer Pickup)

Bills of Lading and Packing Lists should accompany the shipment and be provided to PCHI Receiving Team. The related invoice and a copy of the full set of documents should be sent to the appropriate wholesale entity:

Amscan Inc.  
Attn. Accounts Payable Department  
80 Grasslands Road  
Elmsford, NY 10523  
Attn: [ElmAccPay@amscan.com](mailto:ElmAccPay@amscan.com)



**Section – 9b (Wholesale)**

Anagram International  
Attn: Accounts Payable Department & Purchasing Department  
7700 Anagram Drive  
Eden Prairie, MN 55344  
Attn: Kathy Swendiman, Accounts Payable, [swendimk@anagramintl.com](mailto:swendimk@anagramintl.com)  
Attn: Shawn Ruthford, Purchasing Manager, [ruthfors@anagramintl.com](mailto:ruthfors@anagramintl.com)  
Attn: Kenneth Baron, Purchasing, [barronk@anagramintl.com](mailto:barronk@anagramintl.com)

**Foreign Vendors**

- Foreign Vendors can combine **multiple** PO numbers on one invoice, but they must group the PO numbers together with the items. For example, list the first PO number followed by the item numbers, then the 2<sup>nd</sup> PO number followed by those item numbers, etc. Documents are to be sent at the time of shipment.

**EXAMPLE ONLY**

ITEM NO.	ITEM DESCRIPTION	QTY	MASTER CARTON	TOTAL QUANTITY	M/C PRICE	TOTAL
<u>P.O. NO.: 110011</u>						
303311	DOTS PRISMATIC HATS	(8 PCS/6PKG/108 PKG)	15	1620 PKG	\$50.00	\$750.00
404411	GARDEN FLOWERS INVITATION	(8 PCS/12PKG/216 PKG)	7	1512 PKG	\$70.54	\$493.78
<u>P.O. NO.: 110027</u>						
555444	BALLOONS PINT PAIL	(1 PCS/12PKG/288 PKG)	25	7200 PKG	\$38.00	\$950.00
777888	FLORAL QUART PAIL	(1 PCS/12PKG/288 PKG)	25	7200 PKG	\$49.50	\$1,237.50
<u>P.O. NO.: 110038</u>						
234555	WEDDING HANGING DECORATION	(5 PCS/6PKG/72 PKG)	50	3600 PKG	\$44.25	\$2,212.50
678999	JUMBO GIFT BAG - BLUE	(1 PCS/12PKG/144 PKG)	50	7200 PKG	\$40.00	\$2,000.00

The following information must be included on the invoice:

- The complete PO number, in its exact format with no changes (Do not combine locations on the same invoice).
- Company or division name
- Unique invoice number and invoice date (which must not be prior to the actual date the merchandise was shipped). There must be a unique invoice for each location.

**The invoice number MUST appear on each page of a hard copy multi-page invoice. Invoice numbers MUST NOT be reused.**

- The terms of the sale for the invoice must be clearly indicated
- Remit-to address
- Ship to address
- PCHI item number along with a detailed item description
- The "Each" quantity shipped, "Each" unit cost and extended cost for each item
- The Master Carton (MC) quantity shipped, MC unit cost and extended cost for each item
- Gross cost summation



## Section – 9b (Wholesale)

**Foreign Vendors must provide quantity shipped and cost information both ways – Eaches for Customs purposes and Master Carton for accounting purposes.**

Foreign vendors are required to provide a Bill of Lading with the invoice. The following information must be included on the Bill of Lading:

- Number of cases shipped
- Carrier Name
- Carrier's BOL #

Foreign vendors are required to provide a packing list to accompany the invoice and Bill of Lading. The following information must be included on the Packing List:

- PO number
- Container number
- Item number
- Item description
- Total "each" quantity shipped by item number
- Total Master Carton quantity shipped by item number
- Net weight of each Master Carton by item number
- Cubic measurement of Master Carton by item number

Foreign vendors are required to **upload** a complete set of shipping documents – Invoice, Bill of Lading, and Packing List – to the **designated Freight Forwarder's system** at the time of shipment. **These documents will be transmitted via email distribution list to both Genpact and Amscan Inventory Team. The documents are also transmitted to the Broker's FTP site simultaneously. Document accuracy and timeliness will be closely monitored. In the event of non-compliance, Vendor's scorecard may be adversely affected.**

**For Anagram**, the original set of shipping documents should also be sent to the address below -

Anagram International  
Attn: Import Traffic Manager  
7700 Anagram Drive  
Eden Prairie, MN 55344  
**Attn: Kathy Swendiman, Accounts Payable, [swendimk@anagramintl.com](mailto:swendimk@anagramintl.com)**  
**Attn: Shawn Ruthford, Purchasing Manager, [ruthfors@anagramintl.com](mailto:ruthfors@anagramintl.com)**  
**Attn: Kenneth Baron, Purchasing, [barronk@anagramintl.com](mailto:barronk@anagramintl.com)**

### **Invoice Processing Policies**

Deductions will be taken from invoices with quantity variances caused by carton shortages, merchandise cost differences, and/or non-compliance due to improperly labeled or unlabeled product, non-compliant cartons, and/or non-compliant pallets.

### **Domestic Vendors**

Deductions will be identified **by Accounts Payable with supporting documentation within 2 business days of receipt of remittance**. The reference number will be the original invoice number followed by a CM.

Cash discounts will be calculated based on the gross amount of the invoiced merchandise.



## Section – 9b (Wholesale)

### Foreign Vendors

Deductions will be identified by Accounts Payable with supporting documentation within 2 business days of receipt of the remittance to the vendor.

### Remittance Advice

#### Domestic Vendors

PCHI will issue a single corporate check for multiple invoices. The following information will be provided by Amscan when payments are issued:

- PCHI Vendor Number
- Vendor name
- Vendor remittance address
- Check number
- Check date
- Reference number (Invoice number)
- Reference date (Invoice date)
- Gross Amount
- Discount Amount
- Net amount of invoice

#### Foreign Vendors

Foreign Vendors are paid by electronic transfer. PCHI will transfer a single amount for multiple invoices paid by wire. The following information will be provided within 2 business days of wire transfer receipt to the vendor:

- Vendor Invoice
- Invoice amount

Any deductions will also be listed with clear breakdown of payment total, how it relates to the invoice/debit note # or when credit notes are applied and all supporting documentation will be emailed to the vendor.

### Vendor Inquiries & Correspondence

Vendor inquiries regarding A/P transactions, balances and discrepancies must be directed to the appropriate wholesale A/P Department at the address below:

Amscan Inc.  
Attn: Accounts Payable Dept.  
80 Grasslands Road  
Elmsford NY 10523  
[elmaccpay@amscan.com](mailto:elmaccpay@amscan.com)

Anagram International  
Attn: Accounts Payable Dept.  
7700 Anagram Drive  
Eden Prairie, MN 55344



**Section – 9b (Wholesale)**

Email: [swendimk@anagramintl.com](mailto:swendimk@anagramintl.com)  
[ruthfors@anagramintl.com](mailto:ruthfors@anagramintl.com)  
[barronk@anagramintl.com](mailto:barronk@anagramintl.com)





**HALLOWEEN CITY**



**Section - 10**

**Reimbursement and Waiver Policy**

**Overview**

This section lists our reimbursement policies and charges by category for non-compliance issues for both retail (Party City, Party America, and Halloween City) and wholesale organizations (Amscan and Anagram International). All prior waivers are null and void as of December 31, 2021, unless another expiration date has been given on the waiver. Please see below for the approved waiver policy. **No telephone conversations, verbal agreements or any other agreements made will be honored unless the waiver policy is followed.**

**Reimbursement Charges**

The following chart lists non-compliance issues, the related organization type and the corresponding expense reimbursement charge:

**PLEASE NOTE – There is a \$25 administrative fee for each chargeback issued.**

**Expense Offset Reductions**

CATEGORY: TRANSPORTATION	RULE #	NON-COMPLIANCE ISSUES	REIMBURSEMENT CHARGES
RETAIL/WHOLESALE	10-100	NO LTL DELIVERY APPOINTMENT (Only if delivery is accepted, and not rescheduled)	\$50 PER SHIPMENT AND REDELIVERY CHARGES IF APPLICABLE
RETAIL/WHOLESALE	10-101	INCORRECT CARRIER USED/ FAILURE TO ROUTE ACCORDING TO THE TRANSPORTATION ROUTING GUIDE	\$25 PER INVOICE + FULL FREIGHT
RETAIL/WHOLESALE	10-102	UNAUTHORIZED ACCESSORIAL CHARGES (Notification, lift gate, etc.)	\$25 + ADDITIONAL COST
RETAIL/WHOLESALE	10-103	UNAUTHORIZED AIR SHIPMENTS	\$25 + FREIGHT CHARGES

CATEGORY: PACKING/LABELING/VENDOR DIRECT TO STORE	RULE #	NON-COMPLIANCE ISSUES	REIMBURSEMENT CHARGES
RETAIL/WHOLESALE	10-200	GS1-128 LABEL NOT ON CARTON, INCORRECT LABEL FORMAT, INCORRECT LABEL PLACEMENT OR MORE THAN ONE GS1-128 LABEL ON CARTON	\$10 PER CARTON
RETAIL/WHOLESALE	10-201	NO PACKING SLIP WITH SHIPMENT OR IF THE PACKING SLIP ARRIVES AFTER THE SHIPMENT	\$25 PER SHIPMENT
RETAIL/WHOLESALE	10-202	MULTIPLE POs PER CARTON	\$25 + \$25 PER CARTON
RETAIL/WHOLESALE	10-203	INCORRECT OR MISSING PO NUMBER ON REQUIRED DOCUMENTATION	\$25 PER SHIPMENT
RETAIL	10-204	GS1-128 LABEL NOT SCANNABLE/POOR QUALITY	\$10 PER CARTON
TICKETING/UPC RETAIL/WHOLESALE	10-205	INCORRECT UPC ON PRODUCT OR PACKAGE	(RETAIL) \$100 PER UPC (WHOLESALE) \$25 PER OCCURRENCE + \$.50 PER RETAIL SELLING UNIT
RETAIL/WHOLESALE	10-206	NO UPC TICKET	\$25 PER OCCURANCE + \$.50 PER RETAIL SELLING UNIT
RETAIL/WHOLESALE	10-207	UPC NOT SCANNABLE/POOR QUALITY	\$25 PER OCCURANCE + \$.50 PER RETAIL SELLING UNIT

CATEGORY: PACKING/LABELING/VENDOR DIRECT TO STORE	RULE #	NON-COMPLIANCE ISSUES	REIMBURSEMENT CHARGES
RETAIL/WHOLESALE	10-208	ITEMS INCORRECTLY PRE-PRICED OR REQUESTED ITEMS THAT DO NOT ARRIVE PRE-PRICED	\$25 PER OCCURANCE + COST OF DIFFERENCE PER SELLING UNIT; COST OF PRICING UNPRICED ITEMS \$.25 EACH UNIT
RETAIL/WHOLESALE	10-209	MISSING JULIAN DATE, INCORRECT FORMAT, INCORRECT ITEM # OR UPC OR PLACEMENT	\$25 PER OCCURANCE + \$.50 PER RETAIL SELLING UNIT OR \$5.00 PER INNER/MASTER CARTON ERROR
RETAIL/WHOLESALE	10-210	GS1-128 LABEL NOT MATCHING CARTON LABEL ID SENT IN ON ASN	\$15 PER OCCURANCE

CATEGORY: LOGISTICS	RULE #	NON-COMPLIANCE ISSUES	REIMBURSEMENT CHARGES
RETAIL/WHOLESALE	10-300	INCORRECT OR MISSING PO NUMBER ON REQUIRED DOCUMENTATION	\$100 PER SHIPMENT
WHOLESALE	10-301	INCORRECT, MULTIPLE OR MISSING PO #s or VENDOR #s ON MASTER CARTON	\$100 PER SHIPMENT + \$5 PER CARTON
RETAIL/WHOLESALE	10-302	CARTON LABEL MISSING OR NOT SCANNABLE (POOR QUALITY)/GS1-128 LABEL MISSING OR NOT SCANNABLE (POOR QUALITY) OR INCORRECT UPC ON INNER/MASTER CARTON OR OTHER INCORRECT INFORMATION	\$10 PER CARTON
WHOLESALE	10-303	PALLETS NOT SHRINKWRAPPED (APPLICABLE TO DOMESTIC SHPT ONLY AS OVERSEAS CONTAINERS ARE FLOOR LOADED TO MAX SPACE)	\$25 PER PALLET
WHOLESALE	10-304	LABEL PLACEMENT INCORRECT (INNER OR MASTER)/LABELS NOT FACING OUT ON SHRINK WRAPPED PALLETS	\$.50 PER CARTON
WHOLESALE	10-305	UNACCEPTABLE OVERHANG ON PALLET/PALLET EXCEEDS ALLOWED HEIGHT OR DIMENSIONS (TOPS)	\$20 PER PALLET
WHOLESALE	10-306	INCORRECT PALLET SIZE	\$50 PER PALLET
WHOLESALE	10-307	UNACCEPTABLE PALLET QUALITY	\$75 PER PALLET
WHOLESALE	10-308	INCORRECT CASE PACK DIMENSIONS (TOLERANCE +/-1 inch), PALLET QUANTITY OR PRODUCT NOT SHIPPED IN CARTONS NUMBER, CASE PACK, UPC OR OTHER PERTINENT INFORMATION SUBMITTED ON NEW ITEM SET UP FORM (TOPS)	\$10 PER CARTON
WHOLESALE	10-309	PACKAGING NOT TO STANDARD, SEAL/TAPE, STRENGTH OF CORRUGATED, ROUNDED TOPS AND BOTTOMS, LOOSE FLAPS/STRAPPING OF MASTER CARTON/STAPLES IN MASTER CARTON/EXCEEDS 40 LBS.	\$100 PER SHIPMENT + \$.50 PER CARTON PLUS ANY SPECIAL HANDLING OR RTV CHARGES
WHOLESALE	10-310	SUBMASTERS OR SUBINNERS USED/INCORRECT PACK SIZE OR MULTIPLE PACK SIZES ON ONE PO	\$100 PER SHIPMENT PLUS SPECIAL HANDLING OR RTV CHARGES
WHOLESALE	10-311	PACKING SLIP MISSING, UNUSABLE, DATA MISSING OR INCORRECT	\$100 PER SHIPMENT
WHOLESALE	10-312	ACCESSORIAL CHARGES FOR SPECIAL HANDLING OR REPACKAGING	\$75 PER HOUR PLUS FLAT REIMBURSEMENT CHARGES
WHOLESALE	10-313	RETURN TO VENDOR CHARGES	\$50 PER PALLET PLUS TRANSPORTATION CHARGES

## Section - 10

CATEGORY: LOGISTICS	RULE #	NON-COMPLIANCE ISSUES	REIMBURSEMENT CHARGES
WHOLESALE	10-314	STORAGE OF PRODUCT AWAITING DISPOSITION FROM VENDOR	14 DAYS AFTER NOTIFICATION TO VENDOR - \$10 PER PALLET PER WEEK
WHOLESALE	10-315	DISPOSAL OF NON-SALABLE PRODUCT (NON-HAZARDOUS MATERIAL)	\$5 PER CARTON
WHOLESALE	10-316	RECEIPT OF SUBSTITUTE ITEM OR ITEMS NOT ON PO	ITEM WILL NOT BE PAID FOR + COST OF DISPOSAL. \$200 FINE IF A DECISION IS MADE TO KEEP THE ITEM AND SELL THROUGH STOCK
WHOLESALE	10-317	HAZARDOUS MATERIAL TESTING FEE	\$100 + INVOICE COST FROM PCHI APPROVED LAB
WHOLESALE	10-318	DISPOSAL OF NON-SALABLE PRODUCT (HAZARDOUS MATERIAL)	\$100 + INVOICE COST FROM DISPOSAL COMPANY AND ANY RELATED FEES
WHOLESALE	10-319	MISCELLANEOUS – LOGISTICS	RELATED COSTS AND ADMIN FEES
WHOLESALE	10-320	PRODUCT SAFETY LABELS	\$0.50/PIECE, MINIMUM CHARGE OF \$100
WHOLESALE	10-321	WEIGHTS & MEASURES – INCORRECT CLAIM ON PACKAGING	\$0.25/EA/PIECE, PLUS COST OF MATERIALS AND ANY FINES FROM 3 <sup>RD</sup> PARTY IN APPLICABLE
WHOLESALE	10-322	DETENTION OF SHIPMENT DUE TO FAILURE TO SUBMIT VALID RELEVANT CERTIFICATE FOR CUSTOM CLEARANCE AT DESTINATION	ALL COSTS INCURRED AS A RESULT OF DETENTION AND DEMURRAGE AND PENALTY OF \$1000 PER DAY
WHOLESALE	10-323	ACTUAL SHIPPED QUANTITY NOT MATCHING DECLARED QUANTITY	\$1000 TO PROCEED WITH MANIFEST DISCREPANCY REPORT

CATEGORY: MERCHANDISING	RULE #	NON-COMPLIANCE ISSUES	REIMBURSEMENT CHARGES
RETAIL	10-400	<p>RECEIPTS LATE – EVERYDAY, SEASONAL &amp; NEW STORES.</p> <p>LATE ORDERS ARE ORDERS RECEIVED IN STORE AFTER THE CANCEL-IF-NOT-DELIVERED BY DATE ON YOUR PO SENT VIA EDI</p>	<p>LESS THAN 1 WEEK LATE = 5% OF THE VALUE OF THE LATE MERCHANDISE. 1 WEEK OR GREATER AND LESS THAN 3 WEEKS=15% OF THE VALUE OF LATE MERCHANDISE. 3 WEEKS OR GREATER=25% OF THE VALUE OF LATE MERCHANDISE.</p>
WHOLESALE	10-400(B)	LATE SHIPMENTS WITHOUT APPROVAL – EVERYDAY & SEASONAL (BASED ON THE PROMISE DATE PROVIDED AT ORDER CONFIRMATION-IF THE INVENTORY MANAGER SUBSEQUENTLY APPROVES ANOTHER DATE FOR BOOKING PURPOSES, VENDOR IS STILL LIABLE FOR CHAREGBACK IF VENDOR WAS NOT READY TO BOOK BY THE PROMISE DATE PROVIDED AT TIME OF ORDER CONFIRMATION)	<p>SUPPLIER SHIPS LATE TO THE PO SHIP DATE ON THE PURCHASE ORDER FOR INTERNATIONAL AND LATE TO RECEIPT IN CHESTER FOR DOMESTIC DELIVERIES</p> <ul style="list-style-type: none"> <li>PENALTY ASSESSED ON FOB FOR INTERNATIONAL AND LANDED COST FOR DOMESTIC SUPPLIERS</li> <li>5% FOR 7 DAYS LATE</li> <li>15% FOR 8-21 DAYS LATE</li> <li>25% FOR 22+ DAYS LATE</li> </ul> <p>PCHI HAS THE RIGHT TO CANCEL ANY LATE DELIVERY WITH NO LIABILITY (ASSUMING FAULT IS SUPPLIER AND NOT PCHI)</p>
RETAIL	10-401	SHIPMENTS EARLY – SEASONAL & NEW STORES	5% OF THE VALUE OF THE EARLY MERCHANDISE
WHOLESALE	10-401(B)	SHIP EARLY WITHOUT APPROVAL – EVERYDAY & SEASONAL	20% OF THE VALUE OF THE EARLY MERCHANDISE (this is w/o approval)
RETAIL/WHOLESALE	10-402	INCORRECT PRODUCT COST, ITEM NUMBER, CASE PACK, UPC OR OTHER PERTINENT INFORMATION SUBMITTED ON NEW ITEM SET UP FORM	\$200 PER ITEM THAT IS SUBMITTED INCORRECTLY

CATEGORY: MERCHANDISING	RULE #	NON-COMPLIANCE ISSUES	REIMBURSEMENT CHARGES
RETAIL	10-403	UNAUTHORIZED SHIPPING OF SUBSTITUTE ITEM / ITEMS ASN'D OR INVOICED NOT ON PO (Retail Only- Wholesale does not accept substitutions)	ITEM WILL NOT BE PAID FOR PLUS COST OF DISPOSAL
RETAIL/WHOLESALE	10-405	ITEM FOUND TO BE a) NON-COMPLIANT BY LAB TESTING OR SCANNING, b) DEFECTIVE, OR c) NON-COMPLIANT WITH PRODUCT SPECIFICATION	ITEM WILL BE DESTROYED OR RETURNED TO VENDOR AND FULL CREDIT ON COST OF ITEM, <b>LOST RETAIL PROFIT</b> , TESTING & INSPECTION FEES AND ALL OTHER RELATED EXPENSES WILL BE TAKEN
RETAIL	10-409	INCORRECT DIMENSIONS PROVIDED ON PACKAGING/SAMPLE	\$0.25 PER UNIT
RETAIL/WHOLESALE	10-410	<b>PRODUCT NOT RECEIVED AT ALL FOR A SEASON OR GREATER THAN 4 WEEKS LATE FOR EVERYDAY</b>	<b>COST + LOST PROFIT ON THE ITEM'S UNSHIPED QUANTITY</b>
RETAIL/WHOLESALE	10-411	<b>PRODUCT SHIPPED DIFFERENTLY THAN BUYER APPROVED SAMPLE</b>	<b>COST + LOST PROFIT ON THE ITEM'S UNSHIPED QUANTITY</b> . \$200 FINE IF A DECISION IS MADE TO KEEP THE ITEM AND SELL THROUGH STOCK
RETAIL	10-412	INCORRECT IMAGE PROVIDED FOR WEB, PICTURE WALL & MARKETING VEHICLES	\$200 PER OCCURANCE PLUS COST OF REPRODUCING AND EXPEDITED DELIVERY TO STORES
RETAIL	10-413	PICTURE WALL IMAGE INCORRECTLY MARKED ON ITEM PACKAGE	\$5 PER UNIT PURCHASED (COSTUME BAG RELABELED)
RETAIL	10-414	COSTUME UPC LABELED INCORRECTLY	\$5 PER UNIT PURCHASED (COSTUME BAG RELABELED)
RETAIL	10-415	COSTUME COMPONENTS IN PACKAGE ARE DIFFERENT THAN LISTED ON PICTURE WALL.	PER UNIT PURCHASED (PICTURE \$5 WALL, LOOK BOOK & COSTUME BAG RELABELED)
RETAIL	10-416	COSTUME SIZE SHIPPED DIFFERENT THAN ITEM INFO PROVIDED BY VENDOR	\$100 PER STORE (RELABEL PICTURE WALL AND LOOK BOOK)
RETAIL/WHOLESALE	10-417	<b>ITEM IS DEEMED DAMAGED, DEFECTIVE OR NON-SALABLE</b>	COST + <b>LOST PROFIT ON THE ITEM</b> + Handling, Disposal or Return and Transportation Cost
RETAIL/WHOLESALE	10-418	LABOR CHARGE TO RETURN OVERSHIPMENTS OR DUPLICATE SHIPMENTS AT VENDOR REQUEST	10% OF THE COST OF RETURNED MERCHANDISE – MIN OF \$25
RETAIL	10-419	PO SHIPPED TO WRONG LOCATION	EVERYDAY: 50% OF COST OF TOTAL MIS-SHIPED ORDER / SEASONAL: 100% OF COST OF TOTAL MIS-SHIPED ORDER.
WHOLESALE	10-420	ITEM MISSING COMPONENT(S) PER APPROVED SAMPLE	COST OF MISSING COMPONENT(S) (IF NOT REPLACING), OR COST OF LABOR AND/OR SHIPPING FEES TO REPLACE COMPONENT(S) (IF REPLACING) + \$500 PER OCCURRENCE.
RETAIL	10-421	ITEM PULLED FROM SALES FLOOR DUE TO PRODUCT SAFETY REGULATIONS AND RETURNED TO SALES FLOOR	\$0.50 PER UNIT RE-LABELING + LOST PROFIT ON ITEM
WHOLESALE	10-422	FAILURE TO PROVIDE ACCURATE FACTORY NAME, FACTORY LOCATION, AND CONTACT NAME WITHIN 14 DAYS OF RECEIVING A PURCHASE ORDER	\$100 PER ITEM PLUS ALL EXPENSES RELATED TO LATE OR INSUFFICIENT FACTORY APPROVAL
RETAIL	10-423	INCORRECT OR MISSING DOCUMENTS INCLUDING PRODUCT TESTING, <b>INSPECTION</b> , OR OTHER COMPLIANCE DOCUMENTS	\$500 + COST OF ANY ADDITIONAL CLEARANCE/DUTY OR DISPOSAL COSTS

**Section - 10**

CATEGORY: OTHER	RULE #	VENDOR ALLOWANCE CHARGES	REIMBURSEMENT CHARGES
RETAIL	10-406	AD ALLOWANCE	ALLOWANCE NOT APPLIED TO INVOICE OR BEING APPLIED BY ACCOUNTS PAYABLE
RETAIL/WHOLESALE	10-407	REBATE/VOLUME REBATE	ALLOWANCE NOT APPLIED TO INVOICE OR BEING APPLIED BY ACCOUNTS PAYABLE
RETAIL/WHOLESALE	10-408	MARKDOWN/OTHER ALLOWANCE	ALLOWANCE NOT APPLIED TO INVOICE OR BEING APPLIED BY ACCOUNTS PAYABLE
RETAIL	10-409	CANDY PORTAL CHARGE	\$150 PER VENDOR FOR LICENSING FEE TO TRACK CANDY COMPLIANCE/FACTORY INFO

CATEGORY: ACCOUNTS PAYABLE	RULE #	NON-COMPLIANCE ISSUES	REIMBURSEMENT CHARGES
RETAIL/WHOLESALE	10-500	INVOICE WITHOUT PO NUMBER INCLUDED OR INCORRECT PO NUMBER	\$25 PER INVOICE
RETAIL/WHOLESALE	10-501	INVOICING WITH TERMS OTHER THAN THOSE CONTAINED ON THE PO (OR VPA IF NO TERMS ARE LISTED ON PO) THIS INCLUDES FREIGHT TERMS.	\$25 PER INVOICE
RETAIL/WHOLESALE	10-502	ACCEPTING PO WITH INCORRECT COST	\$25 PER INVOICE
RETAIL/WHOLESALE	10-503	MANUAL INVOICE FOR NON-ASN VENDOR	\$5 PER INVOICE
RETAIL/WHOLESALE	10-504	INVOICE WITH ITEMS NOT ON FILE OR UNAUTHORIZED SHIPMENT OF ITEMS (VMI)	ITEM WILL NOT BE PAID FOR
RETAIL/WHOLESALE	10-505	INVOICES WITH LOAD DATE MORE THAN 7 DAYS AFTER INVOICE DATE. INVOICES SENT MORE THAN 5 DAYS AFTER ASN SENT.	\$5 PER INVOICE
RETAIL/WHOLESALE	10-506	INVOICES LOADED WITH INCORRECT INVOICE DATE OR MISSING CHARGES AND ALLOWANCES	\$5 PER INVOICE
RETAIL/WHOLESALE	10-507	INVOICES WITHOUT SITE # OR WITH INCORRECT SITE #	\$25 PER INVOICE
RETAIL	10-508	INVOICES WHERE HEADER AND DETAIL AMOUNT DOES NOT MATCH, DOCUMENT MUST BE CORRECTED AND RESENT WITHIN 24 HOURS	\$5 PER INVOICE FOR INCORRECT DATA AND \$25 PER INVOICE NOT RESENT IN 24 HOURS

CATEGORY: EDI	RULE #	NON-COMPLIANCE ISSUES	REIMBURSEMENT CHARGES
RETAIL	10-600	RECEIPT OF MANUAL/PAPER CORPORATE STORE INVOICE AFTER EDI CERTIFICATION	\$10 PER INVOICE
RETAIL	10-601	INABILITY TO ACCEPT PO TRANSMITTED VIA EDI REQUIRING MANUAL (FAX, EMAIL, ETC) PO TO BE SENT	\$10 PER PO
RETAIL	10-602	FAILURE TO PROVIDE ASN FOR A SHIPMENT WHEN AN EDI 850 PO WAS SENT.	\$25 PER CARTON
RETAIL	10-603	FAILURE TO SEND THE ASN WITHIN TIMEFRAME OR PRIOR TO SHIPMENT ARRIVING AT STORE	\$10 PER CARTON
RETAIL	10-604	EDI DOCUMENTS REJECTED DUE TO INCORRECT, MISSING, OR DUPLICATE DATA	\$25 PER DOCUMENT
RETAIL	10-605	ALL REJECTED DOCUMENTS NOT CORRECTED AND RE-TRANSMITTED WITHIN 24 HOURS	\$200 PER BATCH/CONTROL #
RETAIL	10-606	INVALID OR MISSING CHARGE OR ALLOWANCE CODE SENT ON INVOICE	\$25 PER INVOICE

## Section - 10

CATEGORY: EDI	RULE #	NON-COMPLIANCE ISSUES	REIMBURSEMENT CHARGES
RETAIL	10-607	MISMATCHED OR MISSING REF SI DATA ON ASN OR INVOICE	\$10 PER INVOICE/\$10 PER ASN ID
RETAIL	10-608	FAILURE TO TRANSMIT 997 ACKNOWLEDGEMENTS BY END OF NEXT BUSINESS DAY AFTER RECEIPT OF TRANSMISSIONS	\$5 PER PO
RETAIL	10-609	ACCEPTANCE/SHIPMENT OF DUPLICATE PO EITHER SENT VIA EDI, FAX OR PDF	\$10 PER CARTON. MERCHANDISE SHIPPED IS FREE OR VENDOR PAYS RETURN SHIPPING COST
RETAIL	10-610	DEVIATIONS FROM EDI MAPPING GUIDELINES RESULTING IN EDI TRANSLATION FAILURE	\$200 PER BATCH CONTROL #
RETAIL	10-611	INCORRECT QUANTITIES ON ASNs OR INVOICES	\$20 PER PURCHASE ORDER NUMBER FOR THE ASN AND INVOICE
RETAIL	10-612	ASN DATA OR INVOICE DATA NOT MATCHING EACH OTHER OR THE PO	\$20 PER INVOICE \$20 PER ASN
RETAIL	10-613	DUPLICATE ASN DATA WITH DIFFERENT CARTON IDs FOR SAME PO OVERSTATING INVENTORY	\$500 PER BATCH
RETAIL/WEB	10-614	APPAREL ITEMS NOT INDIVIDUALLY PACKAGED IN POLYBAGS	\$1.00 PER UNIT

CATEGORY: IMPORTS	RULE #	NON-COMPLIANCE ISSUES	REIMBURSEMENT CHARGES
WHOLESALE	10-700	SHIPMENT WITHOUT PCHI APPROVAL OR WITH INCORRECT OR MISSING DOCUMENTS INCLUDING PRODUCT TESTING OR INSPECTION REPORTS, CONFIRMATION OF PRODUCTION UNITS WITH INSPECTION REFERENCE SAMPLE, OR OTHER COMPLIANCE DOCUMENTS	\$500 PER ITEM + COST OF DEMMURAGE and ANY ADDITIONAL CLEARANCE/DUTY OR DISPOSAL COSTS
WHOLESALE	10-702	INCORRECT CARTON MARKINGS	\$50 + \$5 PER CARTON
WHOLESALE	10-703	INCORRECT DATA OR IMAGE PROVIDED FOR QUOTE TO DETERMINE HTS	\$500 + ADDITIONAL COSTS FOR DUTY, CLEARANCE, STORAGE, DEMURRAGE OR DISPOSAL
WHOLESALE	10-704	ISF LATE, MISSING OR INCORRECT INFORMATION	\$500 + ADDITIONAL COSTS ASSESSED BY US CUSTOMS

CATEGORY: CUSTOM INVITATION/PERS ONALIZATION	RULE #	NON-COMPLIANCE ISSUES	REIMBURSEMENT CHARGES
RETAIL	10-800	DELIVERY AFTER CONFIRMED IN STORE DATE	SUBJECT TO PENALTY UPON VIOLATION
RETAIL	10-801	MISPRINTED ORDERS	SUBJECT TO PENALTY UPON VIOLATION

CATEGORY: DC	RULE #	NON-COMPLIANCE ISSUES	REIMBURSEMENT CHARGES
WHOLESALE	10-900	INCORRECT CARTON MARKINGS OR LABELS	\$5 PER CARTON
WHOLESALE	10-901	MISSING OR DAMAGED CARTON LABEL	\$1 PER CARTON + RE-LABEL FEE
WHOLESALE	10-902	INCORRECT INNER LABEL	\$2 PER INNER + RE-LABEL FEE
WHOLESALE	10-903	MISSING OR DAMAGED INNER LABEL	\$1 PER INNER + RE-LABEL FEE

## Section - 10

CATEGORY: DC	RULE #	NON-COMPLIANCE ISSUES	REIMBURSEMENT CHARGES
WHOLESALE	10-904	DAMAGED OUTER CARTON; VENDOR SENDS CARTON REPLENISHMENT	\$1 PER CARTON FOR RE-PACK
WHOLESALE	10-905	CASE PACK DIMENSIONS CHANGE AFTER VENDOR RECEIVES PURCHASE ORDER	1% DEDUCTION TAKEN OFF PURCHASE ORDER, PER ITEM
WHOLESALE	10-906	CASE PACK QTY CHANGES AFTER VENDOR RECEIVES PURCHASE ORDER	1% DEDUCTION TAKEN OFF PURCHASE ORDER, PER ITEM
WHOLESALE	10-907	STORAGE FEE FOR EARLY OR LATE SHIPMENTS (OUTSIDE OF SHIP WINDOW)	\$0.50 PER CBM PER DAY
WHOLESALE	10-908	ITEM MOVES TO DC FOR LATE DELIVERY (OUTSIDE OF SHIP WINDOW)	2% DEDUCTION TAKEN OFF PURCHASE ORDER, PER ITEM, PLUS ADDITIONAL LOGISTICS COST TO SHIP VIA AMSCAN DC TO RETAIL
WHOLESALE	10-909	ITEM MOVES TO DC FOR FAILED TESTING (INCLUDES RESTRICTED ITEMS)	2% DEDUCTION TAKEN OFF PURCHASE ORDER, PER ITEM, PLUS LOST SALES OF RESTRICTED ITEMS
WHOLESALE	10-910	ITEM MOVES TO DC FOR CIQ ISSUE	10% DEDUCTION TAKEN OFF PURCHASE ORDER, PER ITEM  <i>VENDOR RECEIVES WRITTEN WARNING. THREE (3) WARNINGS MAY DEEM VENDOR DISQUALIFIED FROM SERVING AMSCAN COMPANIES.</i>
WHOLESALE	10-911	PARTS REPLACEMENT / REPACKING	\$1 PER CARTON + \$1 PER PART
WHOLESALE	10-912	PARTS REPLACEMENT / REPACKING – NEW CARTON AND LABELS REQUIRED	\$5 PER CARTON + \$1 PER LABEL
WHOLESALE	10-913	PARTS REPLACEMENT / REPACKING – NEW CARTON AND LABELS REQUIRED	\$5 PER CARTON + \$1 PER LABEL
WHOLESALE	10-914	VENDOR CHANGES FOB PORT 15 DAYS AFTER RECEIVING PURCHASE ORDER	1% DEDUCTION TAKEN OFF PURCHASE ORDER, PER ITEM
WHOLESALE	10-915	VENDOR CHANGES FOB PORT 16-30 DAYS AFTER RECEIVING PURCHASE ORDER	2% DEDUCTION TAKEN OFF PURCHASE ORDER, PER ITEM
WHOLESALE	10-916	VENDOR CHANGES FOB PORT 31 + DAYS AFTER RECEIVING PURCHASE ORDER	3% DEDUCTION TAKEN OFF PURCHASE ORDER, PER ITEM
WHOLESALE	10-917	VENDOR PROVIDES INCORRECT FACTORY INFORMATION	\$100 PER ITEM
WHOLESALE	10-918	VENDOR DOES NOT PROVIDE FACTORY INFORMATION WITHIN 30 DAYS OF RECEIVING PURCHASE ORDER	\$10 PER ITEM
WHOLESALE	10-919	MIXED SKU'S RECEIVED IN SAME CARTON	\$50 PER CARTON + \$1 PER ITEM
WHOLESALE	10-920	MISCELLANEOUS – DC BYPASS	RELATED COSTS AND ADMIN FEES
WHOLESALE	10-921	DELAY OF DELIVERY TO CAUSE SUSPENSION OF WAREHOUSE BYPASS OPERATION	\$5000 PER DAY
WHOLESALE	10-922	ITEMS DELIVERING TO CFS PASS THE SHIP WINDOW FOR BYPASS	2%+ADDITIONAL COSTS INCURRED TO DELIVER TO RETAIL LOCATIONS
WHOLESALE	10-923	INCORRECT PACK-OUT (EACHES PER INNER or INNERS PER MASTER)	\$100 FINE PLUS REPACKING FEES

**NOTE: PCHI will process chargebacks for additional handling expenses, including transportation expenses, as a result of failure to meet the requirements in this Vendor Standards Manual.**

**NOTE: Product with quality assurance or regulatory compliance issues shall have resolution within THIRTY (30) DAYS of incident notice. After 30 days, all applicable product may be**



**HALLOWEEN CITY**

**Section - 10**

disposed of in accordance with local, state, and federal regulations and chargeback initiated in accordance with PCHI terms and conditions for non-compliant merchandise.

**NOTE:** Repeat offenses for non-compliant issues may be subject to a fine of \$250 in addition to current charges.



## Waiver Policy

A vendor requesting a waiver of PCHI policies as defined in this Vendor Standards Manual must contact Party City's Category Manager (for Retail), AmScan's Vendor Relations or Anagram International's Vendor Relations (for Wholesale) in writing or email in advance. Vendor must indicate in detail the policy to be waived and the reason for requesting the waiver. Indicate a timeframe for the waiver, i.e. a date when the vendor expects to comply with Party City policy. Vendor must also provide a contact person for correspondence with Party City, AmScan Inc. or Anagram International.

The request will be reviewed by the appropriate PCHI team. If the request is approved, the vendor will receive a waiver form. If the request is not approved, the vendor will be contacted to discuss the issue.

## Reimbursement Policy

Our expense reimbursement policy is intended to recover the costs incurred by PCHI due to vendor non-compliance to the requirements in the Vendor Standards Manual. Expense offset charges will be applied only when PCHI can clearly document a non-compliance to the 2022 Vendor Standards Manual (VSM) requirements.

If a vendor rebate program is based on purchase volume, the gross purchases will not be reduced, or netted down, by any reimbursement charges.

All inquiries or disputes related to Vendor Compliance Reimbursements to PCHI must be submitted in writing, within 45 days of the date you are notified the deduction is taken. Disputes received after 45 days from the date you are notified will not be reviewed. Vendors are required to demonstrate a chargeback was taken inappropriately prior to review for repayment. Inquiries or disputes should be sent to the appropriate location to the following e-mail address:

**AmScan Inc.**

Vendor Relations  
[vendorrelations@amscan.com](mailto:vendorrelations@amscan.com)

**Anagram International**

Vendor Relations  
[vendorrelations@anagramintl.com](mailto:vendorrelations@anagramintl.com)

**Party City Corporation**

Merchandise Payables  
[accountspayable@partycity.com](mailto:accountspayable@partycity.com)

Disputes must include the following; otherwise, disputes cannot be appropriately reviewed:

- Letter with explanation of dispute
- Copy of the chargeback document(s) or Quality Control Information Sheet
- Transportation documentation if applicable (i.e. BOL, POD, etc.)
- Other documentation supporting dispute



## Party City Contact Information

<b>Merchandise / Accounts Payable</b>			
Merchandise Payables	Correspondence	<a href="mailto:accountspayable@partycity.com">accountspayable@partycity.com</a>	973-453-8736
Don Chapin	Controller	<a href="mailto:dchapin@partycity.com">dchapin@partycity.com</a>	973-453-8787
Brandon Gehm	Finance Operations Director	<a href="mailto:bgehm@partycity.com">bgehm@partycity.com</a>	973-453-8805
Amanda Margotta	Accounts Payable Manager	<a href="mailto:amargotta@partycity.com">amargotta@partycity.com</a>	973-453-8864
<b>Electronic Data Interchange (EDI)</b>			
EDI Correspondence		<a href="mailto:EDI@partycity.com">EDI@partycity.com</a>	
Patty Madden	EDI Specialist	<a href="mailto:pmadden@partycity.com">pmadden@partycity.com</a>	973-453-8765
Sahar Kalsee	EDI Support	<a href="mailto:skalsee@partycity.com">skalsee@partycity.com</a>	973-453-8615
<b>Expense Payables</b>			
Brandon Gehm	Finance Operations Director	<a href="mailto:bgehm@partycity.com">bgehm@partycity.com</a>	973-453-8805
Amanda Margotta	Accounts Payable Manager	<a href="mailto:amargotta@partycity.com">amargotta@partycity.com</a>	973-453-8864
<b>Amscan/Party City Logistics</b>			
Routing	Requests for routing and transportation invoice management	<a href="mailto:Partycity.transportation@genpact.com">Partycity.transportation@genpact.com</a>	
Imports/Exports	Import documentation	<a href="mailto:chbimport@partycity.com">chbimport@partycity.com</a>	
<b>Corporate New Store Merchandise Purchase Orders</b>			
Caryl Kalman	New Store Correspondence	<a href="mailto:ckalman@partycity.com">ckalman@partycity.com</a>	973-453-8878
<b>Franchise New Store Merchandise Purchase Orders</b>			
Crystal Ruiz	International Operations Manager	<a href="mailto:cr Ruiz@partycity.com">cr Ruiz@partycity.com</a>	973-453-8622
<b>Product Safety/Testing/Quality Assurance</b>			
Kevin Lauturner	Product Compliance Manager	<a href="mailto:kelautur@amscan.com">kelautur@amscan.com</a>	914-784-4092
<b>Purchase Orders (Everyday and Seasonal)</b>			
PO Confirmation	PO Administrator	<a href="mailto:POConfirm@partycity.com">POConfirm@partycity.com</a>	973-983-4927 (f)
<b>Vendor Relations</b>			
Vendor Relations Correspondence		<a href="mailto:vendorrelations@partycity.com">vendorrelations@partycity.com</a>	973-983-4915 (f)
<b>Global Compliance Office</b>			
		<a href="mailto:compliance@partycity.com">compliance@partycity.com</a>	
<b>Party City Corporate Address</b>			
Party City Corporation 25 Green Pond Road, Suite 1 Rockaway, NJ 07866			



## Amscan Contact Information

<b>Vendor Relations</b>			
Vendor Relations Correspondence		<a href="mailto:vendorrelations@amscan.com">vendorrelations@amscan.com</a>	914-784-4302 (f)
Kim Aldrich	Quality Control Manager	<a href="mailto:kaldrich@amscan.com">kaldrich@amscan.com</a>	845-469-9116 (p) 845-469-5703 (f)
<b>Amscan/Party City Logistics</b>			
<b>Joe Ribaudo</b>	Director of Distribution	<a href="mailto:jribaudo@amscan.com">jribaudo@amscan.com</a>	
Bill Bennett	Receiving Manager DC	<a href="mailto:bbennett@amscan.com">bbennett@amscan.com</a>	845-469-9116
<b>Sandie Bennett</b>	Sr Manager Transportation DC	<a href="mailto:sbennett@amscan.com">sbennett@amscan.com</a>	845-572-2128
Routing	Transportation Routing including Imports, and transportation invoice management	<a href="mailto:Partycity.transportation@genpact.com">Partycity.transportation@genpact.com</a>	
Import Documentation/ Compliance/ Exports	Import docs	<a href="mailto:chbimport@partycity.com">chbimport@partycity.com</a>	914-784-4135
<b>Accounts Payable</b>			
<b>Accounts Payable</b>	Accounts Payable Manager	<a href="mailto:elmaccpay@amscan.com">elmaccpay@amscan.com</a>	914-784-4039 (p) 914-784-4382 (f)
<b>Inventory</b>			
Karen Knecht	Inventory Manager	<a href="mailto:kknecht@amscan.com">kknecht@amscan.com</a>	914-784-4120 (p) 914-345-8684/8685 (f)
<b>Product Development / Sourcing &amp; Operations</b>			
<b>Scott Lametto</b>	SVP – Product, Party	<a href="mailto:slamentto@amscan.com">slamentto@amscan.com</a>	914-784-1969 (p) 914-447-0951 (f)
<b>Laurie Sutandar</b>	VP – Global Sourcing	<a href="mailto:lsutandar@amscan.com">lsutandar@amscan.com</a>	914-281-3073
<b>Mallory Schneider</b>	Director of Product Development	<a href="mailto:mschneider@amscan.asia">mschneider@amscan.asia</a>	011-852-3655-9206 (p)
<b>Lorne Cytrynbaum</b>	Director – Sourcing & Product Operations	<a href="mailto:lcytrynbaum@amscan.com">lcytrynbaum@amscan.com</a>	914-370-9089 (p)
<b>Product Safety/Testing /Quality Assurance</b>			
Patrick Chan (Asia)	Manager- Product Safety & Compliance	<a href="mailto:pchan@amscan.asia">pchan@amscan.asia</a>	011-852-3655-9185 (p)
Maryann Inzalaco	Product Integrity Administrator	<a href="mailto:minzalac@amscan.com">minzalac@amscan.com</a>	
<b>Shawn Hogue</b>	ACIM	<a href="mailto:shogue@amscan.com">shogue@amscan.com</a>	
<b>Nicole Coleman</b>	Ampro	<a href="mailto:ncoleman@amscan.com">ncoleman@amscan.com</a>	
<b>Kathy Scully</b>	Amsource	<a href="mailto:kscully@amscan.com">kscully@amscan.com</a>	
<b>Tammy Caple</b>	Deco	<a href="mailto:tcaple@amscan.com">tcaple@amscan.com</a>	
<b>Juan Manuel Guerra</b>	Granmark	<a href="mailto:jguerra@granmark.com.mx">jguerra@granmark.com.mx</a>	
<b>Chitra Chauhan</b>	Kookaburra	<a href="mailto:cchauhan@amscan.com">cchauhan@amscan.com</a>	
<b>Amscan Corporate Address</b>		<b>Amscan Asia International Ltd Office Address</b>	
Amscan Inc 80 Grasslands Road Elmsford, NY 10523		PCHI Asia Limited 35/F and 36/F, Saxon Tower 7 Cheung Shun Street Lai Chi Kok , Kowloon Hong Kong	

# HALLOWEEN CITY®

## Halloween City Contact Information

<b>Merchandising</b>			
Sean Thompson	Merchandising Officer	<a href="mailto:sthompson@partycity.com">sthompson@partycity.com</a>	973-453-4601
<b>Logistics</b>			
Steve O'Toole	Logistics Manager	<a href="mailto:sotoole@halloweencity.com">sotoole@halloweencity.com</a>	734-591-1717 x5418
Lisa Foster	General Manager of Distribution Center	<a href="mailto:lfoster@halloweencity.com">lfoster@halloweencity.com</a>	734-591-5456
<b>Accounts Payable</b>			
Amanda Margotta	Accounts Payable Manager	<a href="mailto:amargotta@partycity.com">amargotta@partycity.com</a>	973-453-8864
<b>Product Safety/Testing/Quality Assurance</b>			
Kevin Lauturner	Product Compliance Manager	<a href="mailto:kelautur@amscan.com">kelautur@amscan.com</a>	914-784-4092
<b>Halloween City Corporate Address</b>			
Gags and Games, Inc. d/b/a Halloween City 35901 Veronica Livonia, MI 48150			



## Anagram International Contact Information

<b>Executives</b>			
Cindy Mark	SVP, General Manager	<a href="mailto:markc@anagramintl.com">markc@anagramintl.com</a>	952-949-5740
Chris Wiles	VP, Finance & Administration	<a href="mailto:wilesc@anagramintl.com">wilesc@anagramintl.com</a>	952-949-5676
Molly Kuhl	Sr. Director, U.S. and Canadian Sales	<a href="mailto:kuhlm@anagramintl.com">kuhlm@anagramintl.com</a>	914-703-1591
Mark Sifferlin	SVP Marketing & Product Development	<a href="mailto:msifferlin@anagramintl.com">msifferlin@anagramintl.com</a>	952-949-5760
<b>Vendor Relations / Purchasing / Merchandising</b>			
Shawn Ruthford	Purchasing Manager	<a href="mailto:ruthfors@anagramintl.com">ruthfors@anagramintl.com</a>	952-949-5638
Kenneth Barron	Purchasing	<a href="mailto:barronk@anagramintl.com">barronk@anagramintl.com</a>	952-949-5774
Vendor Relations	Vendor Relations	<a href="mailto:vendorrelations@anagramintl.com">vendorrelations@anagramintl.com</a>	
<b>Logistics</b>			
Adrian Peers	Distribution Center Manager	<a href="mailto:apeers@anagramintl.com">apeers@anagramintl.com</a>	952-949-5647
<b>Accounts Payable</b>			
Kathy Swendiman	Accounts Payable	<a href="mailto:swendimk@anagramintl.com">swendimk@anagramintl.com</a>	952-949-5705
<b>Product Safety/ Testing / Quality Assurance</b>			
Valerie Luebke	Quality Manager	<a href="mailto:luebkev@anagramintl.com">luebkev@anagramintl.com</a>	952-949-5818
Christin Conroy	Product Safety Coordinator	<a href="mailto:cconroy@anagramintl.com">cconroy@anagramintl.com</a>	952-949-5653
Tina Outlaw	R & D Manager	<a href="mailto:toutlaw@anagramintl.com">toutlaw@anagramintl.com</a>	952-949-5636
<b>Anagram International Corporate Address</b>			
Anagram International 7700 Anagram Drive Eden Prairie, MN 55344			



## Partycity.com Web Fulfillment Center

<b>Chief Operating Officers</b>			
Ed Plesa	VP Supply Chain Management	<a href="mailto:eplesa@amscan.com">eplesa@amscan.com</a>	630-579-2070
Dan Moecher	Director of Operations	<a href="mailto:dmoecher@amscan.com">dmoecher@amscan.com</a>	630-579-2095
Jessica Meyer	Inventory Control Manager	<a href="mailto:jmeyer@partycity.com">jmeyer@partycity.com</a>	630-579-2076
<b>Logistics</b>			
Eduardo Juarez	Receiving Supervisor	<a href="mailto:ejuaraz@partycity.com">ejuaraz@partycity.com</a>	630-579-2067
<b>Receiving Appointments</b>			
			630-579-2084
			630-579-2067
<b>Fulfillment Center Address</b>			
Party City 2727 Diehl Road Naperville, IL 60563 Main Telephone Number 331-305-6847			



## Section - 12 (Retail)

### Partycity.com Web Fulfillment Center

#### Packaging

- Only one SKU per carton is permitted.
- Each master case should be made of durable shippable corrugate.
- Maximum master case size is 20" long x 20" wide x 14" high.
- Preferred master case size is 16" long x 10" wide 9" high
- Maximum master case weight of 50 lbs.
- Do not use loose fill for packaging.
- Standard case packs are required. Each item must have a standard and consistent master case quantity and a standard and consistent inner pack quantity.
- If an item (selling unit) consists of multiple pieces, then each piece should be securely packaged within the selling unit packaging. As an example, attaching a mask to the outside of a costume bag is not acceptable.
- Assortments may be shipped in a single carton as long as there is a master ordering SKU for that assortment.
- Hangers for apparel are not allowed.
- Apparel product must be packaged as eaches in polybags or similar sealed packaging, with UPC barcode visible without opening up the package. Apparel products include; T-Shirts, hats, pajama pants, socks, sweaters, scarves, etc.
- Plush items such as fabric covered stuffed toy animals and fabric covered toys must be packaged as eaches in polybags or similar sealed packaging. UPC barcode must be visible without opening the package.
- Fragile items such as glassware and cups should be packaged in a fashion that will prevent damage during parcel shipping.

#### Labeling

Each master case should be labeled with the following human readable information:

Shipping Label

- Ship to
- Ship from
- P.O. number
- Carrier information:
  - Tracking number
  - PRO number
  - BOL number

**Labeling Continued**

Item description label or printing on master case must contain the following human readable information:

- SKU number and vendor part number of the item contained within
- Description of item
- Quantity contained within and case pack info
- Case pack information

GS1-128 ASN labels should be affixed to the lower right-hand corner of the longest side of each box; and should contain ASN information for contents of each carton.

A pallet-level ASN label which reflects the entire contents of the pallet to which it is affixed is acceptable as long as all cartons on the pallet have human readable item description and quantity on them.

Each ASN label must reference the unique license plate number (LPN). One LPN should **not** be used to correspond to multiple pallets, **nor** to multiple cases within a single pallet. The LPN must be unique and must fall within the range assigned to each vendor.

**UPCs**

- Each inner pack must be labeled with a valid scannable UPC that is reflective of the item and quantity contained within the inner.
- Each selling unit must be labeled with a valid scannable UPC, which is clearly visible, and is reflective of the individual selling unit.

**ASN Requirements**

ASNs must be sent for each shipment. One of two ASN formats is acceptable:

- The **preferred** ASN is a nested ASN. This ASN should contain a pallet-level identification number (LPN) for each pallet, a case-level identification number (LPN) for each case on a pallet, and the cases on each pallet should be linked to the pallet they are on.
- An **alternative** ASN may contain a pallet-level identification number (LPN), with only item-level information about all cases and items on the pallet. It will be assumed that each item on the pallet is divided into standard case size.

**Packing slips**

- A packing slip is required for each shipment.
- One packing list per P.O.
- Packing list should contain the following information:
  - P.O. number
  - List each item, description, SKU or part number
  - Quantity shipped of each item
  - Total cases
  - Total units





## Section - 12 (Retail)

### Preparation And Packaging for Battery Powered Devices With Batteries Included

The packaging requirements specified in the (attached) DOT Special Provision 130 must be followed for battery powered devices with batteries included.

#### Deliveries

- Pallets:
  - Shipments in excess of 50 cubic feet must be palletized.
  - Standard GMA 48" x 40" 4-way pallets must be used.
  - Pallets must be grade B or better – no missing, broken or spliced boards
- Only one P.O. is permitted on each bill of lading.
- On multiple P.O. shipments, product must be tendered in a segregated manner (multiple P.O.s must not be mixed on the same pallet).
- Product should be tendered in a sorted and segregated manner. When multiple cases of each item are shipped, they should be shipped on the same pallet.
- Pallets must be stretch wrapped.
- Delivery appointments should be made for any delivery in excess of 200 cases or 2,000 pounds. Call 630-579-2084 or 630-579-2067.

#### Consumable Items

- All consumable items must be labeled with an expiration date or date code.
- Minimum of 6 months of dating is required upon receipt into the D.C.
- Inner packs must be sealed.

#### Contact Information

Fulfillment Center: 2727 Diehl Road  
Naperville, IL 60563

Receiving Appointments: 630-579-2084 / 630-579-2067

#### Web Fulfillment Center Management Contact List

Ed Plesa	<b>VP - Distribution</b> eplesa@amscan.com	630-579-2070
Dan Moecher	Director of Operations dmoecher@amscan.com	630-579-2095
Eduardo Juarez	Receiving Supervisor ejuarez@partycity.com	630-579-2067
Jessica Meyer	Inventory Control Manager jmeyer@partycity.com	630-579-2076

**Party City**

**HALLOWEEN CITY**

**PARTY  
AMERICA**

**amscan**  
THE PARTY PEOPLE

**anagram**

# Party City Holdings, Inc



**2022**

**Appendix**



**HALLOWEEN CITY**



## Glossary

The following is a list of key terms commonly used throughout this guide.

Term	Definition
Advanced Shipping Notice (ASN)	Common term for the 856 Ship Notice/Manifest EDI transaction set. An ASN contains shipping and item information relative to a particular shipment. ASNs enable the recipient to plan for receipt of the shipment and to automate the merchandise receiving process.
Back Order	Any shipments against a Purchase Order (PO) after the first shipment.
Cartons	Enclosed storage unit for product received from a vendor.
Case	An enclosed storage unit for product shipped to a Party City location.
Case pack	The packaging of the same item in multiple quantities. Sometimes referred to as a master pack, # of selling units in a standard vendor carton.
Cube	The length, width and height of an item or container.
CBM	Cubic Meter
Consolidated Freight Station (CFS)	Vendor delivers truck with product to consolidator. Consolidator unloads, warehouses and loads container. Vendor is charged a fee.
Cube utilization	Determined by counting the total cubic feet of materials stored in a Party City location and expressing the number as a percentage of the total cubic dimensions. Using racks to increase storage space can increase cube utilization.
Cubiscan	Accurately measure the weight and dimensions of a carton
CY	Direct to Warehouse - Vendor picks up container and vendor loads container, seals, brings to ocean vessel and loading zone.
DDP	Delivered Duty Paid - Vendors are responsible for delivery to the Party City Corporation Distribution Center (PCC DC) door, including all freight costs, duties, and customs clearance under vendor's own importer of record number. Party City Corporation takes possession of goods upon receipt at our PCC DC locations.
Drayage	The movement or hauling a heavy container or shipment.
Each	A single selling unit.
Electronic Data Interchange (EDI)	The computer-to-computer transmission of documents between two companies. Computer-to-computer implies that all information contained in the document is capable of being read and processed without human intervention.
EDI Service Provider	A company that performs EDI on behalf of its clients. Most service providers offer various levels of EDI services tailored to a client's needs ranging from fax to web based EDI.
EDI Software Provider	A company that markets software solutions (ranging from PC-based solutions to A-400/mainframe based systems) that enable a company to perform EDI transactions in-house. Some software solutions are specifically designed to accommodate Party City's EDI documents. These packages are solely the product and responsibility of the company that markets them.



# HALLOWEEN CITY

Term	Definition
Exceptions	Any discrepancies with merchandise that cause a delay with merchandise being processed in the facility (e.g. no allocation, invalid UPCs, and unacceptable substitutions).
Flat	A material handling classification of product, which may be processed and shipped in cartons or totes. Generally, apparel and peg board merchandise.
FCA	Free Carrier Alongside
FCR	Forwarder's Cargo Receipt
Floor Ready Merchandise (FRM)	Merchandise that is ready for sale when received.
FOB	Free On Board AKA Port of Origin (POO) - Vendors are responsible for delivery to Party City Corporation's designated freight forwarder at the foreign port. Party City Corporation is responsible for import freight costs and customs clearance and takes possession of goods upon Forwarder Cargo Receipt (FCR) issuance.
Inner Pack	A unit pack that is less than the master pack but larger than the selling unit.
Item setup	Process for establishing a new product in our systemic item file. All items must go through this process prior to being handled.
LDP	Landed Duty Paid AKA Port of Entry (POE) - Vendors are responsible for delivery to the port of entry and can include the terminal railhead located nearest to the PCC DC destination. LDP includes all freight costs and customs clearance under the vendor's own importer of record number. Party City Corporation takes possession of the goods after clearing customs.
License Plate Number (LPN)	A bar-coded label with unique non-repeating numbers used to identify a load of merchandise. Includes the item number, quantity, and location and is put on all totes being moved through a Party City distribution operation.
Loading Term	How product is delivered to forwarder for export
Master Pack	The largest individual packaging unit available. Also known as a case pack.
Merchandise Management System	Allocation system used for inventory management (MMS).
New Vendor	A vendor doing business 90 days or less from the date of their first PO.
New Vendor Package	A grouping of documents (Welcome Letter, VSM, and VPA) sent to a vendor to establish proper vendor relations and documentation.
Non-conveyable items	Items too large to be sent through the sortation system. These items are transported manually to shipping where they are scanned and loaded directly onto an outbound trailer.
Order Create Date	The day that the PO is initiated by a Merchandise Manager or authorized Planning and Allocations associate.
Off-Site Receiving (OSR)	A receiving facility that is separate from a retail location.
POE	Port of Entry – See LDP
POO	Port of Origin – See FOB
PO Receipt	The amount of product received on a specific shipment for a specific SKU to be applied in allocation and replenishment to specific stores. The specific amount of product to be shipped to stores on a single shipment and not spread across multiple shipping days.



# HALLOWEEN CITY®

Term	Definition
Pallet	A portable platform made of wood, metal, or plastic on which merchandise is stacked to facilitate handling, storing, and transporting with manual or mechanical equipment.
Pre-existing Vendor	A vendor doing business for more than 90 days from the date of their first PO.
Purchase Order (PO)	Information sent to vendors to request merchandise for a specific location. Includes manufacturer item number, quantity, price and discounts, vendor information, and ship-to-information.
Receiving Area	The location where shipments arrive from suppliers and are checked in.
Regional Distribution Center (RDC)	A central receiving and shipping point which processes merchandise for shipments to select stores based on store allocations.
Reimbursement	Deductions against any current or future invoice to recover expenses incurred due to vendor non-compliance.
Requested Ship Date	The day the vendor tenders shipment. The order quantity must match the tendered quantity. Back orders will not be accepted.
Routing	Transporting instructions passed from a Load Control Center to vendors sending product to a Party City distribution location and the sending of product to stores.
Ship To – Mark For	Merchandise that is vendor prepared, floor ready, and picked/packed for a specific store. It is received at a Party City distribution location and shipped to the “marked for” store.
TOPS	Total Optimization Packaging Software
Vendor Participation Agreement (VPA)	Standardized form of Party City requirements for all merchandise trading partners. A current copy must be on file to receive Party City POs.



# HALLOWEEN CITY®

## Breakdown of Party City's Departments

Dept #	Dept Name	Dept #	Dept Name
85	Helium Tank Rental	166	Business Development
97	Party Goods - Non Taxable	168	Balloon Accessories
99	Party Goods - Taxable		
101	Mylar Balloons		
102	Baby		
103	Wedding		
104	Party Themes		
105	Solids		
106	General Entertaining	207	Dr Seuss
108	Sports	217	Rentals
109	General Decorations	218	NFL/Superbowl
110	Serveware	219	Valentines Day
111	Birthday Bakeware	220	St. Patricks Day
112	Pinatas	221	Easter
113	Gift Wrap	222	Communion/Confirmation
114	Invites/Thank You	223	Graduation
115	Birthday Accessories	224	Patriotic
116	Non Seasonal Candy	225	Summer
117	Kids Favors	226	Halloween
133	Greeting Cards (SBT)	227	Costumes
134	General Birthday	228	Fall
135	1st Birthday	229	Thanksgiving
137	Kids Birthday	230	Hannukah
138	Cocktail Party	231	Christmas
139	General Candles	232	New Years
140	Rentals	236	Specialty Holiday
141	Custom Album	244	Seasonal Candy
142	Event Planning	255	Costume Accessories
143	Latex Balloons	256	Mardi Gras
145	Professional Sports	266	Spring
146	Web Digital Invitations	267	Seasonal Balloons
147	Inscribe		
148	Web Personalization		
149	Web Personalized Favors		
157	Foil		
158	Special Effects		
159	Premium Entertaining		
160	Gifts	350	Non Revenue
161	Greeting Cards	351	Supplies
162	Color City	352	Coupons
163	Fashion Wearables	353	Other
164	Toys	354	Freight
165	Kids Favors (SBT)	399	Aged

**The Party City department listing is accurate as of the release of the 2022 VSM. However, if there are any changes, Party City will notify all of our vendor partners.**

HALLOWEEN CITY

Unit of Measure



**Carton**  
Shipping receptacle.

Selling Unit = 1  
ALWAYS!



**Selling Unit**  
One (1) unit of sellable product.

Ex: SKU 71073– 50 Ct Forks – Pretty Pink



12 **cartons** on a pallet.



**Case Pack**  
Number of **selling units** in a standard vendor **carton**.

Ex. **12 selling units** (4 layers of 3 *selling units*)

	Shipments to PCC DC	Shipments to PCC Store (DSD)
Pack Qty	Number of <b>selling units</b> in a carton for a shipment to a PCC DC. Defined by vendor. Ex. DC Pack Qty = <b>12 selling units</b>	Number of <b>selling units</b> in a carton for a shipment to a PCC Store. Can be between 1 and the standard vendor case pack <b>qty</b> . Ex. DSD Pack Qty = <b>1 selling unit</b>
Minimum Order Qty	Minimum number of selling units vendor requires PCC to buy for shipment to a PCC DC. Must be a multiple of the <b>pack qty</b> for PCC DC. Ex. 12 cartons of 12 selling units. DC minimum order qty – 12x12 = <b>144 selling units</b>	Minimum number of selling units vendor will ship to a PCC store. Typically equals 1 <b>selling unit</b> but can be greater than 1. Ex. Vendor will not ship any less than 1 selling unit to a store. DSD min order qty = <b>1 selling unit</b>
Pack Cost	Cost to PCC of PCC DC pack qty Ex. DC Pack Cost = <b>\$2.22</b> (DC pack cost) / (DC pack qty) = DC selling unit cost <b>\$2.22/12 = \$0.185</b>	Cost to PCC of DSD pack qty Ex. DSD Pack Cost = <b>\$0.185 NOTE:</b> DSD Pack Cost often equals the DC selling unit cost.



**Case Pack Dimensions:**

Height in inches  
 Length/Depth in inches  
 Width in inches  
 Weight in lbs.

**Planogram Dimensions:**

POG Height in inches – Top to bottom  
 POG Length/Depth in inches – Front to back  
 POG Width in inches – Side to Side along the shelf or as pegged item





**Add/Edit New Item Information**

- Instructions:**
1. Enter new item information into the table below. Each item should be entered on a separate line.
  2. All fields must be completed; "notes" are optional. Shaded cells are calculated and cannot be changed.
  3. To remove a line item, select the "DELETE LINE" button and enter the "Count" number in the popup box. The line will be highlighted for deletion and you can not undo it.
  4. Upon completion of the form, select "Back to Vendor Main Menu" and proceed to Step 3.

Vendor Name:	sample	Date:	
Vendor Number:	9999	Vendor Contact Phone:	999-999-9999
Vendor Contact Person:	Sample	Vendor Contact Email:	Sample@email.com

Count	Description	Vendor Item #	DC Cost				DSD Cost				MSRP	UPC	Mult. UPC	Haz. Mat.	Country of Origin	POG / Product Dimensions			Case Pack Dimensions				Notes
			Pack Qty	Minimum Order Qty	Pack Cost	DC Unit Cost	Pack Qty	Minimum Order Qty	Pack Cost	DSD Unit Cost						Height (Inches)	Width (Inches)	Depth (Inches)	Height (Inches)	Width (Inches)	Depth (Inches)	Weight (Lbs.)	
1	Description	12345					1	1	\$1.000	\$1.000	\$2.00	368276121318		No	China	TBD	TBD	TBD	0.00	0.00	0.00	0.00	
														No	China	TBD	TBD	TBD					
														No	China	TBD	TBD	TBD					
														No	China	TBD	TBD	TBD					
														No	China	TBD	TBD	TBD					
														No	China	TBD	TBD	TBD					
														No	China	TBD	TBD	TBD					

# JULIAN DATE CALENDAR

(Perpetual, non-leap years)  
 (2022, 2023, 2025, 2026, 2027, 2029, 2030 etc...)

Day	Jan	Feb	Mar	Apr	May	June	July	Aug	Sept	Oct	Nov	Dec	Day
1	001	032	060	091	121	152	182	213	244	274	305	335	1
2	002	033	061	092	122	153	183	214	245	275	306	336	2
3	003	034	062	093	123	154	184	215	246	276	307	337	3
4	004	035	063	094	124	155	185	216	247	277	308	338	4
5	005	036	064	095	125	156	186	217	248	278	309	339	5
6	006	037	065	096	126	157	187	218	249	279	310	340	6
7	007	038	066	097	127	158	188	219	250	280	311	341	7
8	008	039	067	098	128	159	189	220	251	281	312	342	8
9	009	040	068	099	129	160	190	221	252	282	313	343	9
10	010	041	069	100	130	161	191	222	253	283	314	344	10
11	011	042	070	101	131	162	192	223	254	284	315	345	11
12	012	043	071	102	132	163	193	224	255	285	316	346	12
13	013	044	072	103	133	164	194	225	256	286	317	347	13
14	014	045	073	104	134	165	195	226	257	287	318	348	14
15	015	046	074	105	135	166	196	227	258	288	319	349	15
16	016	047	075	106	136	167	197	228	259	289	320	350	16
17	017	048	076	107	137	168	198	229	260	290	321	351	17
18	018	049	077	108	138	169	199	230	261	291	322	352	18
19	019	050	078	109	139	170	200	231	262	292	323	353	19
20	020	051	079	110	140	171	201	232	263	293	324	354	20
21	021	052	080	111	141	172	202	233	264	294	325	355	21
22	022	053	081	112	142	173	203	234	265	295	326	356	22
23	023	054	082	113	143	174	204	235	266	296	327	357	23
24	024	055	083	114	144	175	205	236	267	297	328	358	24
25	025	056	084	115	145	176	206	237	268	298	329	359	25
26	026	057	085	116	146	177	207	238	269	299	330	360	26
27	027	058	086	117	147	178	208	239	270	300	331	361	27
28	028	059	087	118	148	179	209	240	271	301	332	362	28
29	029		088	119	149	180	210	241	272	302	333	363	29
30	030		089	120	150	181	211	242	273	303	334	364	30
31	031		090		151		212	243		304		365	31

# JULIAN DATE CALENDAR

For Leap Years Only  
(2024, 2028, 2032, 2036, etc...)

Day	Jan	Feb	Mar	Apr	May	June	July	Aug	Sept	Oct	Nov	Dec	Day
1	001	032	061	092	122	153	183	214	245	275	306	336	1
2	002	033	062	093	123	154	184	215	246	276	307	337	2
3	003	034	063	094	124	155	185	216	247	277	308	338	3
4	004	035	064	095	125	156	186	217	248	278	309	339	4
5	005	036	065	096	126	157	187	218	249	279	310	340	5
6	006	037	066	097	127	158	188	219	250	280	311	341	6
7	007	038	067	098	128	159	189	220	251	281	312	342	7
8	008	039	068	099	129	160	190	221	252	282	313	343	8
9	009	040	069	100	130	161	191	222	253	283	314	344	9
10	010	041	070	101	131	162	192	223	254	284	315	345	10
11	011	042	071	102	132	163	193	224	255	285	316	346	11
12	012	043	072	103	133	164	194	225	256	286	317	347	12
13	013	044	073	104	134	165	195	226	257	287	318	348	13
14	014	045	074	105	135	166	196	227	258	288	319	349	14
15	015	046	075	106	136	167	197	228	259	289	320	350	15
16	016	047	076	107	137	168	198	229	260	290	321	351	16
17	017	048	077	108	138	169	199	230	261	291	322	352	17
18	018	049	078	109	139	170	200	231	262	292	323	353	18
19	019	050	079	110	140	171	201	232	263	293	324	354	19
20	020	051	080	111	141	172	202	233	264	294	325	355	20
21	021	052	081	112	142	173	203	234	265	295	326	356	21
22	022	053	082	113	143	174	204	235	266	296	327	357	22
23	023	054	083	114	144	175	205	236	267	297	328	358	23
24	024	055	084	115	145	176	206	237	268	298	329	359	24
25	025	056	085	116	146	177	207	238	269	299	330	360	25
26	026	057	086	117	147	178	208	239	270	300	331	361	26
27	027	058	087	118	148	179	209	240	271	301	332	362	27
28	028	059	088	119	149	180	210	241	272	302	333	363	28
29	029	060	089	120	150	181	211	242	273	303	334	364	29
30	030		090	121	151	182	212	243	274	304	335	365	30
31	031		091		152		213	244		305		366	31

These are all the Country Codes for vendors that we currently have active items with:

<b>Code</b>	<b>Country</b>
CN	China
CO	Columbia
MX	Mexico
US	USA
VN	Vietnam
MY	Malaysia
IT	Italy
ID	Indonesia
MO	Macau
TW	Taiwan
IN	India
SV	El Salvador
ES	Spain
CA	Canada
PH	Philippines
MG	Madagascar
KH	Cambodia
HU	Hungary
LK	Sri Lanka
MM	Myanmar
GB	United Kingdom
TH	Thailand
NI	Nicaragua

			PCHI Requirement	Effective Date for Shipment Receipt by PCHI
<b>Packaging (CONEG-Toxics in Packaging Clearinghouse - TPCH)</b>				
	Lead, Cadmium, Mercury, Hexavalent Chromium Phthalates (including those listed below for child items) Perfluoroalkyl & Polyfluoroalkyl substances (PFAS)	May not contain sum total in excess May not contain sum total in excess May not contain any amount	100 ppm 100 ppm Prohibited 0.1ppm	Already in Effect Pending State Implementation
<b>Art Materials</b>				
	Non-Toxic, TRA, LHAMA Compliant, Prop 65	Crayons, markers, paints, etc may not contain total lead in excess of:  Artist Paints according to Prop 65:	90 ppm  Lead: 12.5 ppm Cadmium: 2.5ppm	Already in Effect  Already in Effect
<b>Children's Items (Toys, Party Favors, etc. for ages 0-14 yrs)</b>				
Toys cannot contain any of the following substances, if accessible during foreseeable use: a) carbon tetrachloride or any substance that contains it. b) methyl alcohol or any substance with greater than 1% methyl alcohol. c) petroleum distillates exceeding 10% by weight. d) benzene (under 100 ppm) e) turpentine or any substance with > 10% turpentine f) boric acid or salts of boric acid. g) ethyl ether h) cobalt (under 40 ppm)	Lead (Pb) in Surface Coating  Toy (<12 yrs) & Childcare (<6 yrs) items sold in Illinois  Mercury (Hg) in Surface Coating  Cadmium (Cd) in Surface Coating	May not contain total amount in excess of:	90 ppm  40 ppm  10 ppm  75 ppm (40 ppm WA)	Already in Effect Already in Effect Already in Effect Already in Effect
	Lead (Pb) in Substrate (plastic, wood, metal, rubber) Lead (Pb) in Substrate for Childcare (<6 yrs) items sold in Illinois  Cadmium (Cd) in Substrate  Styrene CAS #100-42-5 - Styrofoam items	Accessible(1) components may not contain total amounts in excess of:	90 ppm  40 ppm  75 ppm (40 ppm WA) 500 ppm or 27 µg/day (CA)	Already in Effect Already in Effect Already in Effect Already in Effect
<b>Other Heavy Metals (soluble, surface coating and accessible substrate)</b>				
	Mercury (Hg) [Substrate only] Antimony (Sb) Arsenic (As) Barium (Ba) Chromium (Cr) Selenium (Se)	May not contain Heavy Metals in excess of the limits specified:	60 ppm 60 ppm 25 ppm 1,000 ppm 60 ppm 500 ppm	Already in Effect Already in Effect Already in Effect Already in Effect Already in Effect
Phthalates: DBP, DEHP(DOP), BBP, DINP, DNOP, DIDP, DIOP, DIBP, DPP(DPENP), DnHP (DHEXP), DCHP, DEP, MBP (CAS#131-70-4)	Accessible (1) Components of Toys and Childcare (2) Articles. Apply to all child items in states of CA, ME, OR, VT & WA.		Under 0.1% under 1000 ppm	Already in Effect
<p>(1) Accessibility of a component determined before and after use &amp; abuse testing. DBP, DEHP (DOP), BBP, DINP, DIBP, DPP (DPENP), DnHP (DHEXP), and DCHP for CPSIA. DIOP is under CPSC review.</p> <p>(2) For definition of "Childcare" See CPSC Guidelines for CPSIA.</p> <p>(3) Limits apply to reusable or secondary packaging. Also note that for phthalate replacements,</p> <ul style="list-style-type: none"> <li>• Manufacturers must use the least toxic alternative;</li> <li>• Manufacturers cannot replace the phthalate(s) with substance(s) rated by the United States (US) EPA as an A, B, or C carcinogen, or known by the US EPA to cause birth defects; and</li> </ul> <p>Manufacturers cannot replace the phthalate(s) with substance(s) on the State list. (DIDP, DEP, DNOP &amp; MBP regulated by one or more states)</p>				

		PCHI Requirement	Effective Date of Shipment Receipt by PCHI
<b>(Other Non-Children's Products):</b> Phthalates DEHP, BBP, DBP, DnHP, DIDP and DINP Lead in Substrate and Surface Coating Cadmium in Substrate and Surface Coating Mercury in Surface Coating Styrene (CAS# 100-42-5) - Styrofoam items	Presence as defined by:	Prop 65: 0.1% for phthalates Under 90 ppm total (or lower as required by law) Under 300 ppm total Under 10 ppm total Prop 65: 500 ppm or 27 µg/day	Already in Effect Already in Effect Already in Effect Already in Effect Already in Effect
<b>Jewelry – Children (0-14yrs):</b> Lead – Surface Coating and Substrate Cadmium (Cd) – Surface Coating & Substrate Cobalt (Co) – Surface Coating and Substrate Mercury (Hg) – Surface Coating <b>Other Heavy Metals – Surface Coating:</b> Antimony (Sb) Arsenic (As) Barium (Ba) Chromium (Cr) Nickel (Ni) Selenium (Se) Benzene	May not contain total Pb in excess of: May not contain total Cd in excess of: May not contain total Co in excess of: May not contain total Hg in excess of: May not contain soluble levels excess of:  Metal Jewelry substrates may not contain soluble heavy metals (using EN-71, Part 3) in excess of the limits specified:	90 ppm (40 ppm limit for Illinois) 75 ppm (40 ppm for WA) 40 ppm 10 ppm <b>ASTM 963 levels below:</b> 60 ppm 25 ppm 1000 ppm 60 ppm 500 ppm 930 ppm 100 ppm	Already in Effect Already in Effect Already in Effect Already in Effect  Already in Effect Already in Effect Already in Effect Already in Effect Already in Effect Already in Effect
<b>Jewelry – Adults:</b> Lead – Surface Coating & Substrate Cadmium (Cd) – Surface Coating & Substrate Mercury (Hg) – Surface Coating	May not contain total lead in excess of: May not contain total Cd in excess of: May not contain total Hg in excess of: (Other Heavy Metals subject to Children's Jewelry requirements above)	90 ppm 75 ppm 10 ppm	Already in Effect Already in Effect Already in Effect
<b>Food Contact Material:</b>  <b>Food Packaging:</b>	For a definition of food contact material and the applicable limits see: <b>All Perfluoroalkyl and Polyfluoroalkyl (PFAS)</b>	<a href="https://www.fda.gov/Food/IngredientsPackagingLabeling/PackagingFCS/RegulatoryStatusFoodContactMaterial/default.htm">https://www.fda.gov/Food/IngredientsPackagingLabeling/PackagingFCS/RegulatoryStatusFoodContactMaterial/default.htm</a> & Prop 65 <b>No detectable amount (NY, ME, WA), (CT) &amp; (VT)</b>	Already in Effect  <b>1/1/22 / 7/1/23 / 12/31/23</b>
Styrene (CAS# 100-42-5)		500 ppm or 27 µg/day (California)	Already in Effect
<b>Cosmetics:</b>  <b>California Toxic-Free Cosmetics Act</b>	May not contain total amounts of Heavy Metals in excess of:  <b>Must not include Long-chain per- &amp; polyfluoroalkyl substances</b>	Lead (Pb) 5 ppm, Mercury (Hg) 1 ppm, Arsenic (As) 3 ppm, Cadmium (Cd) 3 ppm, Antimony (Sb) 5 ppm, Chromium (Cr) 50 ppm, Manganese (Mn) 100 ppm. Other Heavy Metals use Child Jewelry soluble limits above <b>Ex: PFAS, PFOA, PFOS – see PCHI Chemical letter for all CAS #</b> <a href="https://leginfo.ca.gov/faces/billTextClient.xhtml?bill_id=201920200AB2762">https://leginfo.ca.gov/faces/billTextClient.xhtml?bill_id=201920200AB2762</a>	Already in Effect  <b>01/01/2025</b>
<b>Batteries</b> Batteries in Products for EU	May not contain Mercury May not contain total amounts in excess of	No Detectable Level over 1 ppm Cadmium: 20 ppm, Lead: 40 ppm	Already in Effect
<b>Brominated and Other Flame Retardants</b>	May not contain Penta BDE, Octa BDE, Deca, BDE, TDCPP, TCEP, TCPP, HBCD, and Antimony Trioxide:	No Detectable Level	Already in Effect
<b>Formaldehyde – Fabrics and Textiles</b>	May not have levels in excess of:	20 ppm (ages and sizes <3 years old) 75 ppm (ages and sizes 3 years old and above)	Already in Effect
<b>Bisphenol A (BPA)</b>	May not contain BPA (Provide childcare product labeling per WI law)	No detectable level over 1 ppm	Already in Effect
<b>Formaldehyde - Products made from Composite Woods:</b> Products offered for sale in California must comply with the requirements of the California Air Resource Board (CARB) Airborne Toxics Control Measure (ATCM) by maintaining chain of custody documentation which certifies use of compliant raw materials.			Already in Effect
<b>Traceability:</b> Please refer to our Vendor Standards Manual, where we encourage placement of the Julian date code and factory code on each package surface (master, inner, and each) to enable determination of the day, year and location of production. If the "each" does not have a package, the date and factory codes should be placed on the product. Children's products will need permanent distinguishing marks on the product, to the extent practicable, to identify the item#, manufacturer, and location and date of production, for all goods manufactured on or after 8/14/09 as follows: "www.amscan.com - vendor#_item#_year_country of origin"			
<b>For Additional Information or questions, please contact:</b> Ray Cheung (AmScan Hong Kong): <a href="mailto:rcheung@amscan.asia">rcheung@amscan.asia</a> / Kevin Lauturner (AmScan US/Party City/Halloween City): <a href="mailto:kelaatur@amscan.com">kelaatur@amscan.com</a>			

## **VSM Addendum Against Trafficking in Persons and Modern Slavery**

Party City Holdings Inc. (collectively “Party City” or the “Company”) is committed to identifying and preventing any adverse human rights impact resulting from our business activity and expects our suppliers to share our commitment. We strive to ensure ethical and responsible labor practices throughout the Company’s supply chain.

Consistent with the foregoing, Party City will not tolerate or condone human trafficking or slavery, including forced and unlawful child labor, in any part of our supply chain. In addition, we comply with applicable laws relating to human trafficking and modern slavery, including the U.S. Tariff Act, the Countering Americas Adversaries Through Sanctions Act, the Trafficking Victims Protection Act, the California Transparency in Supply Chains Act, the UK Modern Slavery Act, and any other national, state, provincial or local law or regulation addressing trafficking in persons and modern slavery, and we expect our suppliers to do the same.

Party City’s Supplier Code of Conduct requires suppliers of our products to observe all applicable local labor laws and conduct business in an ethical and responsible manner. This Addendum to Party City’s Vendor Standards Manual (the “VSM”) provides additional detail concerning the foregoing requirement.

By signing the Notification and Acknowledgement of Party City’s VSM, suppliers certify and agree that:

1. They do not engage in any form of trafficking in persons or any form of forced labor, including indentured labor, slavery, child labor, prison, or bonded labor, and that no such forms of labor exist within their supply chains.
2. They provide employees with a safe and healthy workplace in compliance with all applicable laws and regulations, ensuring at a minimum reasonable access to potable water and sanitary facilities, fire safety, and adequate lighting and ventilation. Suppliers will also ensure that the same standards of health and safety are applied in any housing that they provide for an employee and their immediate family.
3. They do not destroy, conceal, confiscate, or otherwise deny access to an individual’s identity or immigration documents.
4. They do not charge, or permit labor brokers or recruiters to charge, employees labor or recruitment fees.
5. They treat each employee with dignity and respect, and do not use corporal punishment, threats of violence or other forms of physical, sexual, psychological or verbal harassment or abuse or coercion.
6. To the best of their knowledge, all components and materials they incorporate into Company products are free of slavery and human trafficking and produced in compliance with all laws relating thereto.

7. No components or materials in any products furnished to the Company were directly or indirectly sourced from North Korea, and no North Korean labor, whether located in North Korea or abroad, was involved in the manufacture of items for Party City.
8. They will maintain a due diligence program to support compliance with the requirements of this Addendum.
9. They will maintain adequate documentation to demonstrate compliance with the requirements of this Addendum.
10. Party City may perform such investigations and audits as it shall deem appropriate in its sole discretion to verify compliance with the Supplier Code of Conduct and the VSM, including this Addendum.

Should any supplier become aware or have reason to believe that a violation of this Addendum has occurred, the supplier shall immediately notify Party City via the channels below:

Telephone: (800) 405-8943

Online: [www.tnwinc.com/reportline/amscan](http://www.tnwinc.com/reportline/amscan)



# Special Provision 130

## (49 CFR 172.102)

130 Dry batteries not specifically covered by another entry in the §172.101 Table must be described using this entry. Batteries described as “Batteries, dry, sealed, n.o.s” are hermetically sealed and generally utilize metals (other than lead) and/or carbon as electrodes. These batteries are typically used for portable power applications. The rechargeable (and some non-rechargeable) types have gelled alkaline electrolytes (rather than acidic) making it difficult for them to generate hydrogen or oxygen when overcharged and therefore, differentiating them from non-spillable batteries. “Batteries, dry, sealed, n.o.s.” are not subject to any other requirements of this subchapter except for the following:

(1) Incident reporting requirements. For transportation by aircraft, a telephone report in accordance with §171.15(a) is required if a fire, violent rupture, explosion or dangerous evolution of heat ( *i.e.* , an amount of heat sufficient to be dangerous to packaging or personal safety to include charring of packaging, melting of packaging, scorching of packaging, or other evidence) occurs as a direct result of a dry battery. For all modes of transportation, a written report submitted, retained, and updated in accordance with §171.16 is required if a fire, violent rupture, explosion or dangerous evolution of heat occurs as a direct result of a dry battery or battery-powered device;

(2) Batteries and battery-powered device(s) containing batteries must be prepared and packaged for transport in a manner to prevent:

(i) A dangerous evolution of heat;

(ii) Short circuits, including but not limited to the following methods:

(a) Packaging each battery or each battery-powered device when practicable, in fully enclosed inner packagings made of non-conductive material;

(b) Separating or packaging batteries in a manner to prevent contact with other batteries, devices or conductive materials ( *e.g.* , metal) in the packagings; or

(c) Ensuring exposed terminals or connectors are protected with non-conductive caps, non-conductive tape, or by other appropriate means; and

(iii) Damage to terminals. If not impact resistant, the outer packaging should not be used as the sole means of protecting the battery terminals from damage or short circuiting. Batteries must be securely cushioned and packed to prevent shifting which could loosen terminal caps or reorient the terminals to produce short circuits. Batteries contained in devices must be securely installed. Terminal protection methods include but are not limited to the following:

(a) Securely attaching covers of sufficient strength to protect the terminals;

(b) Packaging the battery in a rigid plastic packaging; or

(c) Constructing the battery with terminals that are recessed or otherwise protected so that the terminals will not be subjected to damage if the package is dropped.

(3) When transported by aircraft, for a battery whose voltage (electrical potential) exceeds 9 volts:

(i) When contained in a device, the device must be packaged in a manner that prevents unintentional activation or must have an independent means of preventing unintentional activation ( *e.g.* , packaging restricts access to activation switch, switch caps or locks, recessed switches, trigger locks, temperature sensitive circuit breakers, etc.); and

(ii) An indication of compliance with this special provision must be provided by marking each package with the words “not restricted” or by including the words “not restricted” on a transport document such as an air waybill accompanying the shipment.

# Factory Name

Factory Address  
TEL. No.

---

## **Certification Statement of Impact Resistance**

RE:  
IMPACT RESISTANCE TEST NO.:  
PO#  
INVOICE NO.:  
COMMODITIES: SUNGLASSES  
QUANTITIES: \_\_\_ PCS / \_\_\_ CARTONS  
Date:

(Factory Name)

hereby guarantees that the articles listed herein are impact-resistant within the meaning of 21 CFR 801.410 and have been tested pursuant to that section. Impact-resistant lenses are not unbreakable or shatterproof. The lenses meet an AQL of 6.5 when tested by the drop ball test or an equal or superior test method. Records of testing will be maintained for a period of three (3) years from the date of shipment, and copies will be forwarded to FDA upon request.

Factory Name and Address:

(PLACE FACTORY'S CHOP STAMP HERE)



# Certificate Of Fda Registration

## 2011.05-2012.05

This is certified that:  
At The Address Stated Below Has Completed U.S. FOOD AND DRUG  
ADMINISTRATION Medical Device Registration Through MANTON.

**NINGBO HAISHU GOOD PARTNER TRADING CO.,LTD.**  
**Add: Rm2401-2419, No.58, Lane 136, Shunde road**  
**Ningbo, CHINA 315400**

Proprietary Device Name	SUNGLASSES
Device Name(s)	SUNGLASSES (NON-PRESCRIPTION INCLUDING PHOTSENSITIVE)
Device Document Number	D048174
Product Code	HQY
Premarket Submission Number	Exempt
Owner/Operator Number	10025393
Date of Registration Status	2011
Registration Number	3006985453

**MTG FDA** *Jacky M. Chuang*  
**REGISTRATION** *Jacky M. Chuang*  
**CENTER** *Executive Director*  
*Date: 2011/04/28*

**CONCLUSION:**

This certificate is only valid for the equipment and configuration described, in conjunction with the test data detailed above.

This certificate makes no other representations or warranties, nor does it imply any representation or warranty to any person or entity other than the named certificate holder. Manton assumes no liability to any person or entity in connection with the foregoing.

**FDA NOTICE:**

The fee should be paid as soon as possible after registering your device (print or submitting your annual establishment registration information electronically). Be sure to allow for enough time for your payment to be received and recorded. Your registration is not complete until FDA notifies you that all requirements have been met.



Start Date: \_\_\_\_\_  
 Product Manager: \_\_\_\_\_  
 Merchandiser: \_\_\_\_\_

**\*\*NOTE\*\***  
 Any Samples You Receive In Regard To This Quote Are For Reference Only.  
 Please Quote On Sample Provided, Following Any Direction Or Comments Supplied  
 All Batteries Must Be Mercury Free [Instructions](#)  
 All Materials Must Be Phthalate Free  
 Product Material Must Be Specific (Include Paper Weights, Types Of Plastic, Plastic Weights, %, Etc.)

Quote Date	Photo	Quote Type	SKU Specifications											Vendor Information										Price Breaks										Tooling Cost				Master Carton (Inches/Pounds)							Notes	Upload	
			Amscan Item #	Amscan ref #	Product Description	Product Dimension %	Product # of Colors	Product Details	Product Material	Retail Package Count	Package Type	Package # of Colors	Current FOB	% Saving	Vendor Item #	Vendor Name	New Vendor (Y/N)	Factory Name	Factory ID (FIDI)	New Factory (Y/N)	Sample Lead Time	Production Lead Time	Country of Origin	FOB Port	Inner Qty	Poly Bag Inner	Inner Type	400 Inner Qty	400 Inner FOB Cost	800 Inner Qty	800 Inner FOB Cost	1200 Inner Qty	1200 Inner FOB Cost	2000 Inner Qty	2000 Inner FOB Cost	MOQ	FOB Cost at MOQ	Mold/Plate Charges	Rebate Threshold	Rebate Units	MC Qty	MC Length	MC Width	MC Height		MC Cube (Feet)	MC Weight
			550017.40		Premium Paper Plate Multipack - Apple Red	10.5" x 7.5"																	4	N														4	11.500	8.800	11.625	0.681	6.550	2.300	0.000		
			550017.05		Premium Paper Plate Multipack - Orange Peel	10.5" x 7.5"																	4	N													4	11.300	8.800	11.700	0.673	6.400	2.300	0.000			
			550017.09		Premium Paper Plate Multipack - Yellow Sunshine	10.5" x 7.5"																	4	N													4	20.500	11.000	11.300	1.475	8.580	2.300	0.000			
			550017.57		Premium Paper Plate Multipack - Vanilla Creme	10.5" x 7.5"																	4	N												4	11.400	8.700	11.400	0.654	6.750	2.300	0.000				
			550017.03		Premium Paper Plate Multipack - Festive Green	10.5" x 7.5"																	4	N												4	11.500	8.800	11.700	0.685	6.700	2.300	0.000				
			550017.53		Premium Paper Plate Multipack - Kiwi	10.5" x 7.5"																	4	N												4	11.500	8.900	12.000	0.711	6.600	2.300	0.000				
			550017.10		Premium Paper Plate Multipack - Bright Royal Blue	10.5" x 7.5"																	4	N												4	11.400	8.900	11.800	0.693	6.570	2.300	0.000				
			550017.54		Premium Paper Plate Multipack - Caribbean	10.5" x 7.5"																	4	N												4	11.400	8.700	11.900	0.683	6.700	2.300	0.000				
			550017.34		Premium Paper Plate Multipack - True Navy	10.5" x 7.5"																	4	N												4	11.400	8.900	11.900	0.699	6.650	2.300	0.000				
			550017.12		Premium Paper Plate Multipack - Robins Egg Blue	10.5" x 7.5"																	4	N												4	11.400	9.000	11.900	0.707	6.650	2.300	0.000				
			550017.10		Premium Paper Plate Multipack - New Purple	10.5" x 7.5"																	4	N												4	11.400	9.100	12.100	0.726	6.650	2.300	0.000				
			550017.04		Premium Paper Plate Multipack - Lavender	10.5" x 7.5"																	4	N												4	11.400	8.900	12.000	0.705	6.600	2.300	0.000				
			550017.10		Premium Paper Plate Multipack - Bright Pink	10.5" x 7.5"																	4	N												4	11.200	9.300	11.800	0.711	6.450	2.300	0.000				
			550017.10		Premium Paper Plate Multipack - New Pink	10.5" x 7.5"																	4	N												4	11.400	8.600	12.000	0.681	6.900	2.300	0.000				
			550017.10		Premium Paper Plate Multipack - Jet Black	10.5" x 7.5"																	4	N												4	11.400	9.000	11.700	0.695	6.650	2.300	0.000				
			550017.19		Premium Paper Plate Multipack - Gold	10.5" x 7.5"																	4	N												4	11.300	9.100	12.000	0.714	6.600	2.300	0.000				
			550017.18		Premium Paper Plate Multipack - Silver	10.5" x 7.5"																	4	N												4	11.300	8.800	11.700	0.673	6.400	2.300	0.000				
			550017.08		Premium Paper Plate Multipack - Frosty White	10.5" x 7.5"																	4	N												4	20.500	11.000	11.300	1.475	8.580	2.300	0.000				